

# SERVICE MANUAL

# BA-5D CHASSIS

<u>MODEL NAME</u>	<u>REMOTE COMMANDER</u>	<u>DESTINATION</u>	<u>CHASSIS NO.</u>
<b>KV-27FV310</b>	RM-Y181	US	SCC-65K-A
<b>KV-27FV310</b>	RM-Y181	CND	SCC-64G-A
<b>KV-29FV310</b>	RM-Y181	LATIN NORTH	SCC-62P-A
<b>KV-29FV310</b>	RM-Y181	LATIN SOUTH	SCC-62Q-A
<b>KV-32FV310</b>	RM-Y181	US	SCC-65M-A
<b>KV-32FV310</b>	RM-Y181	CND	SCC-64J-A
<b>KV-36FV310</b>	RM-Y181	US	SCC-65Q-A
<b>KV-36FV310</b>	RM-Y181	CND	SCC-64M-A
<b>KV-36FV310</b>	RM-Y181	HAWAII	SCC-67E-A

**ORIGINAL MANUAL ISSUE DATE: 4/2003**

**REVISION DATE**

**SUBJECT**

4/2003  
10/2003

No revisions or updates are applicable at this time.  
Updated Rear Cover PN 6-2. Picture Tube (KV-27FV310/29FV310 Only) and  
6-4. Picture Tube (KV-32FV310 Only) (Replace Pgs. 58 & 60)

# SERVICE MANUAL

# BA-5D CHASSIS

<u>MODEL NAME</u>	<u>REMOTE COMMANDER</u>	<u>DESTINATION</u>	<u>CHASSIS NO.</u>
<b>KV-27FV310</b>	RM-Y181	US	SCC-65K-A
<b>KV-27FV310</b>	RM-Y181	CND	SCC-64G-A
<b>KV-29FV310</b>	RM-Y181	LATIN NORTH	SCC-62P-A
<b>KV-29FV310</b>	RM-Y181	LATIN SOUTH	SCC-62Q-A
<b>KV-32FV310</b>	RM-Y181	US	SCC-65M-A
<b>KV-32FV310</b>	RM-Y181	CND	SCC-64J-A
<b>KV-36FV310</b>	RM-Y181	US	SCC-65Q-A
<b>KV-36FV310</b>	RM-Y181	CND	SCC-64M-A
<b>KV-36FV310</b>	RM-Y181	HAWAII	SCC-67E-A



KV-36FV310



RM-Y181

TRINITRON® COLOR TELEVISION

**SONY®**

## TABLE OF CONTENTS

SECTION TITLE	PAGE
Specifications .....	4
Warning and Cautions .....	5
Safety Check-Out .....	6
Self-Diagnostic Function.....	7
<b>SECTION 1: DISASSEMBLY.....</b>	<b>10</b>
1-1. Rear Cover Removal.....	10
1-3. Service Position REMOVAL .....	10
1-2. Chassis Assembly Removal.....	10
1-4. Picture Tube Removal.....	11
Anode Cap Removal Procedure.....	11
<b>SECTION 2: SET-UP ADJUSTMENTS.....</b>	<b>12</b>
2-1. Beam Landing.....	12
2-2. Convergence.....	13
2-3. Focus .....	14
<b>SECTION 3: SAFETY RELATED ADJUSTMENTS.....</b>	<b>16</b>
3-1. <input checked="" type="checkbox"/> RV8002 Confirmation Method (HV Hold-Down Confirmation) and Readjustments.....	16
<b>SECTION 4: CIRCUIT ADJUSTMENTS.....</b>	<b>17</b>
4-1. Setting the Service Adjustment Mode .....	17
4-2. Memory Write Confirmation Method .....	17
4-3. Remote Adjustment Buttons and Indicators .....	17
4-4. Service Data Lists .....	18
4-5. ID Map Table .....	25
4-6. A Board Adjustments.....	26
<b>SECTION 5: DIAGRAMS.....</b>	<b>29</b>
5-1. Circuit Boards Location .....	29
5-2. Printed Wiring Board and Schematic Diagram Information.....	29
5-3. Block Diagrams .....	30
5-4. Schematics and Supporting Information .....	34
A Board Schematic Diagram .....	34
HR Board Schematic Diagram.....	39
BC Board Schematic Diagram .....	40
P Board Schematic Diagram.....	43
Y Board Schematic Diagram.....	45
HU Board Schematic Diagram .....	46
D Board Schematic Diagram.....	47
V Board Schematic Diagram.....	49
GK Board Schematic Diagram .....	51
C Board Schematic Diagram.....	54
5-5. Semiconductors.....	56
<b>SECTION 6: EXPLODED VIEWS.....</b>	<b>57</b>
6-1. Chassis (KV-27FV310/29FV310 ONLY) .....	57
6-2. Picture Tube (KV-27FV310/29FV310 ONLY).....	58
6-3. Chassis (KV-32FV310 ONLY).....	59
6-4. Picture Tube (KV-32FV310 ONLY).....	60
6-5. Chassis (KV-36FV310 ONLY).....	61
6-6. Picture Tube (KV-36FV310 ONLY).....	62
<b>SECTION 7: ELECTRICAL PARTS LIST.....</b>	<b>63</b>

## SPECIFICATIONS

	KV-27FV310 KV-29FV310(N)	KV-29FV310(S)	KV-32FV310	KV-36FV310
<b>Power requirements</b>	120V, 60Hz	220V, 50/60 Hz	120V, 60Hz	120V, 60Hz
<b>Number of Inputs/Outputs</b>				
<b>Video</b> <sup>1)</sup>	3	3	3	3
<b>S Video</b> <sup>2)</sup>	2	2	2	2
<b>Y, P<sub>B</sub>, P<sub>R</sub></b> <sup>3)</sup>	2	2	2	2
<b>Audio</b> <sup>4)</sup>	3	3	3	3
<b>Audio Out</b> <sup>5)</sup>	1	1	1	1
<b>Monitor Out</b>	1	1	1	1
<b>Speaker output (W)</b>	7.5 W X 2, 15 Wsubwoofer	7.5 W X 2, 15 Wsubwoofer	7.5 W X 2, 15 Wsubwoofer	7.5 W X 2, 15 Wsubwoofer
<b>Power Consumption (W)</b>				
<b>In use (Max)</b>	220 W	220 W	230 W	230 W
<b>In Standby</b>	1W	1W	1W	1W
<b>Dimensions(W x H x D)</b>				
<b>mm</b>	784 x 601.5 x 520 mm	784 x 601.5 x 520 mm	898 x 682 x 584 mm	1020 x 760 x 640 mm
<b>in</b>	30 <sup>7/8</sup> x 23 <sup>11/16</sup> x 20 <sup>1/2</sup>	30 <sup>7/8</sup> x 23 <sup>11/16</sup> x 20 <sup>1/2</sup>	35 <sup>3/8</sup> x 26 <sup>7/8</sup> x 23	40 <sup>1/4</sup> x 30 x 25 <sup>1/4</sup>
<b>Mass</b>				
<b>kg</b>	48 kg	48 kg	78 kg	102 kg
<b>lbs</b>	105 lbs. 13 oz.	105 lbs. 13 oz.	171 lbs. 15 oz.	224 lbs. 14 oz.

### Television system

American TV standard, NTSC

### Channel coverage

VHF: 2-13/ UHF: 14-69/ CATV: 1-125

### Picture tube

FD Trinitron<sup>®</sup> tube

### Visible screen size

27 inch picture measured diagonally (KV-27FV310/29FV310)

32 inch picture measured diagonally (KV-32FV310)

36 inch picture measured diagonally (KV-36FV310)

### Actual screen size

29 inch measured diagonally (KV-27FV310/29FV310)

34 inch measured diagonally (KV-32FV310)

38 inch measured diagonally (KV-36FV310)

### Antenna

75-ohm external antenna terminal for VHF/UHF

### Supplied Accessories

Size AA (R6) batteries (2)

Remote Control RM-Y181 (1) (KV-27FV310/29FV310/32FV310/36FV310)

### Optional Accessories

TV Stand: SU-27F1 for (KV-27FV310/29FV310)

SU-32F1 for (KV-32FV310)

SU-36F1 for (KV-36FV310)

- 1) 1 Vp-p 75 ohms unbalanced, sync negative
- 2) Y: 1 Vp-p 75 ohms unbalanced, sync negative  
C: 0.286 Vp-p (Burst signal), 75 ohms
- 3) Y: 1.0 Vp-p, 75 ohms, sync negative;  
PB: 0.7 Vp-p, 75 ohms  
PR: Vp-p, 75 ohms
- 4) 500 mVrms (100% modulation), Impedance: 47 kilohms
- 5) More than 408 mVrms at the maximum volume setting (variable)  
More than 408 mVrms (fix)

# XBR

**TruSurround™**  
by **SRS** (SOUND RETRIEVAL SYSTEM)

TruSurround is a trademark of SRS Labs, Inc. SRS and the SRS symbol are registered trademarks of SRS Labs, Inc. in the United States and in select foreign countries. SRS and TruSurround are incorporated under license from SRS Labs, Inc. and are protected under United States Patent Nos. 4,748,669 and 4,841,572 with numerous additional issued and pending foreign patents. Purchase of this product does not convey the right to sell recordings made with the TruSurround technology.

### ( ● ) SRS (SOUND RETRIEVAL SYSTEM)

The ( ● ) SRS (SOUND RETRIEVAL SYSTEM) is manufactured by Sony Corporation under license from SRS Labs, Inc. It is covered by U.S. Patent No. 4,748,669. Other U.S. and foreign patents pending.

The word 'SRS' and the SRS symbol ( ● ) are registered trademarks of SRS Labs, Inc.

BBE and BBE symbol are trademarks of BBE Sound, Inc. and are licensed by BBE Sound, Inc. under U.S. Patent No. 4,638,258 and 4,482,866.



## WARNING AND CAUTIONS

### CAUTION

Short circuit the anode of the picture tube and the anode cap to the metal chassis, CRT shield, or carbon painted on the CRT, after removing the anode.

### WARNING!!

An isolation transformer should be used during any service to avoid possible shock hazard, because of live chassis. The chassis of this receiver is directly connected to the ac power line.

### SAFETY-RELATED COMPONENT WARNING!!

Components identified by shading and  mark on the schematic diagrams, exploded views, and in the parts list are critical for safe operation. Replace these components with Sony parts whose part numbers appear as shown in this manual or in supplements published by Sony. Circuit adjustments that are critical for safe operation are identified in this manual. Follow these procedures whenever critical components are replaced or improper operation is suspected.

---

### ATTENTION!!

Après avoir déconnecté le cap de l'anode, court-circuiter l'anode du tube cathodique et celui de l'anode du cap au châssis métallique de l'appareil, ou la couche de carbone peinte sur le tube cathodique ou au blindage du tube cathodique.

Afin d'éviter tout risque d'électrocution provenant d'un châssis sous tension, un transformateur d'isolement doit être utilisé lors de tout dépannage. Le châssis de ce récepteur est directement raccordé à l'alimentation du secteur.

### ATTENTION AUX COMPOSANTS RELATIFS A LA SECURITE!!

Les composants identifiés par une trame et par une marque  sur les schémas de principe, les vues explosées et les listes de pièces sont d'une importance critique pour la sécurité du fonctionnement. Ne les remplacer que par des composants Sony dont le numéro de pièce est indiqué dans le présent manuel ou dans des suppléments publiés par Sony. Les réglages de circuit dont l'importance est critique pour la sécurité du fonctionnement sont identifiés dans le présent manuel. Suivre ces procédures lors de chaque remplacement de composants critiques, ou lorsqu'un mauvais fonctionnement suspecté.

## SAFETY CHECK-OUT

After correcting the original service problem, perform the following safety checks before releasing the set to the customer:

1. Check the area of your repair for unsoldered or poorly soldered connections. Check the entire board surface for solder splashes and bridges.
2. Check the interboard wiring to ensure that no wires are "pinched" or touching high-wattage resistors.
3. Check that all control knobs, shields, covers, ground straps, and mounting hardware have been replaced. Be absolutely certain that you have replaced all the insulators.
4. Look for unauthorized replacement parts, particularly transistors, that were installed during a previous repair. Point them out to the customer and recommend their replacement.
5. Look for parts which, though functioning, show obvious signs of deterioration. Point them out to the customer and recommend their replacement.
6. Check the line cords for cracks and abrasion. Recommend the replacement of any such line cord to the customer.
7. Check the B+ and HV to see if they are specified values. Make sure your instruments are accurate; be suspicious of your HV meter if sets always have low HV.
8. Check the antenna terminals, metal trim, "metallized" knobs, screws, and all other exposed metal parts for AC leakage. Check leakage as described below.

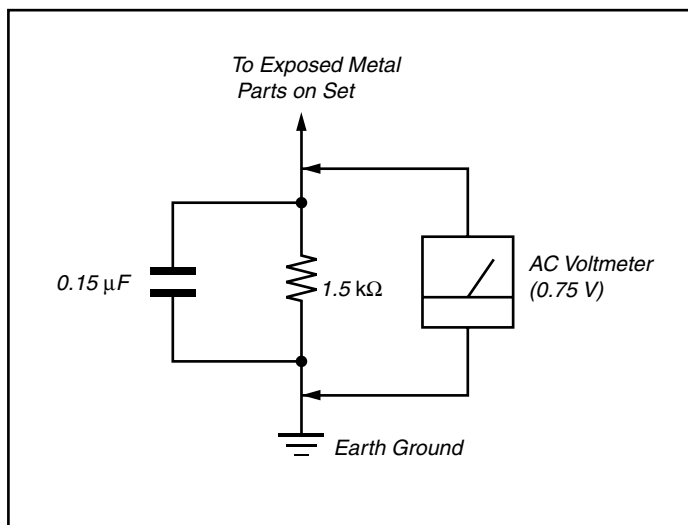

Figure A. Using an AC voltmeter to check AC leakage.

### Leakage Test

The AC leakage from any exposed metal part to earth ground and from all exposed metal parts to any exposed metal part having a return to chassis, must not exceed 0.5 mA (500 microamperes). Leakage current can be measured by any one of three methods.

1. A commercial leakage tester, such as the Simpson 229 or RCA WT-540A. Follow the manufacturers' instructions to use these instructions.
2. A battery-operated AC milliampmeter. The Data Precision 245 digital multimeter is suitable for this job.
3. Measuring the voltage drop across a resistor by means of a VOM or battery-operated AC voltmeter. The "limit" indication is 0.75 V, so analog meters must have an accurate low voltage scale. The Simpson's 250 and Sanwa SH-63TRD are examples of passive VOMs that are suitable. Nearly all battery-operated digital multimeters that have a 2 VAC range are suitable (see Figure A).

### How to Find a Good Earth Ground

A cold-water pipe is a guaranteed earth ground; the cover-plate retaining screw on most AC outlet boxes is also at earth ground. If the retaining screw is to be used as your earth ground, verify that it is at ground by measuring the resistance between it and a cold-water pipe with an ohmmeter. The reading should be zero ohms.

If a cold-water pipe is not accessible, connect a 60- to 100-watt trouble-light (not a neon lamp) between the hot side of the receptacle and the retaining screw. Try both slots, if necessary, to locate the hot side on the line; the lamp should light at normal brilliance if the screw is at ground potential (see Figure B).

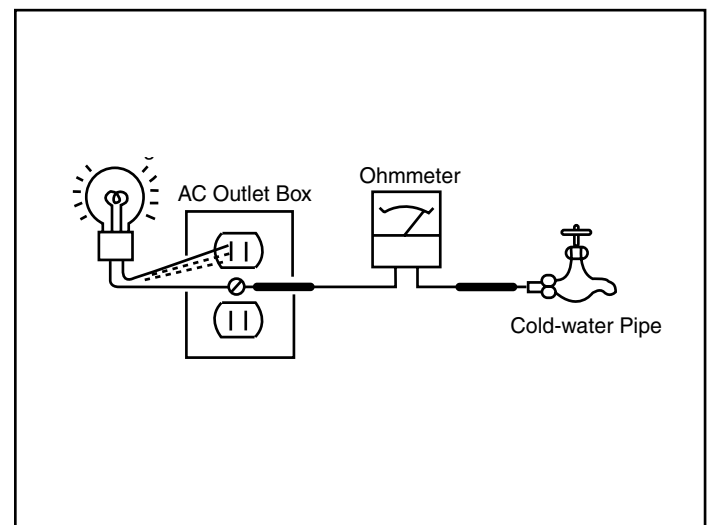

Figure B. Checking for earth ground.

## SELF-DIAGNOSTIC FUNCTION



The units in this manual contain a self-diagnostic function. If an error occurs, the STANDBY/TIMER LED will automatically begin to flash. The number of times the LED flashes translates to a probable source of the problem. A definition of the STANDBY/TIMER LED flash indicators is listed in the instruction manual for the user's knowledge and reference. If an error symptom cannot be reproduced, the Remote Commander can be used to review the failure occurrence data stored in memory to reveal past problems and how often these problems occur.

### Diagnostic Test Indicators

When an error occurs, the STANDBY/TIMER LED will flash a set number of times to indicate the possible cause of the problem. If there is more than one error, the LED will identify the first of the problem areas.

Results for all of the following diagnostic items are displayed on screen. If the screen displays a "0", an error has occurred.

Diagnostic Item	No. of times STANDBY / TIMER lamp flashes	Probable Cause Location	Detected Symptoms
Power does not turn on	Does not light	<ul style="list-style-type: none"> <li>Power cord is not plugged in.</li> <li>Fuse is burned out (F601). (GK Board)</li> </ul>	<ul style="list-style-type: none"> <li>Power does not come on.</li> <li>No power is supplied to the TV.</li> <li>AC Power supply is faulty.</li> </ul>
+B overcurrent (OCP)*	2 times	<ul style="list-style-type: none"> <li>H.OUT (Q502) is shorted. (A Board)</li> <li>IC702 is shorted. (C Board)</li> </ul>	<ul style="list-style-type: none"> <li>Power does not come on.</li> <li>Load on power line shorted.</li> </ul>
+B overvoltage (OVP)	3 times	<ul style="list-style-type: none"> <li>IC501 is faulty. (A Board)</li> <li>If a high is supplied to pin 2 of IC501. (A Board)</li> </ul>	<ul style="list-style-type: none"> <li>Has entered standby mode.</li> </ul>
V-Stop	4 times	<ul style="list-style-type: none"> <li>+12V is not supplied. (A Board)</li> <li>IC561 is faulty. (A Board)</li> </ul>	<ul style="list-style-type: none"> <li>Has entered standby state after horizontal raster.</li> <li>Vertical deflection pulse is stopped.</li> <li>Power line is shorted or power supply is stopped.</li> </ul>
IK (AKB)	5 times	<ul style="list-style-type: none"> <li>Video OUT (IC561) is faulty. (A Board)</li> <li>IC702 is faulty. (C Board)</li> <li>Screen (G2) is improperly adjusted. **</li> </ul>	<ul style="list-style-type: none"> <li>No raster is generated.</li> <li>CRT Cathode current detection reference pulse output is small.</li> </ul>
Zero Cross	9 times	<ul style="list-style-type: none"> <li>No zero cross pulses on pin 45 IC1001. (A Board)</li> </ul>	<ul style="list-style-type: none"> <li>Power does not come on.</li> </ul>
9V Check	10 times	<ul style="list-style-type: none"> <li>Relay failed (RY600)</li> </ul>	<ul style="list-style-type: none"> <li>Power does not come on.</li> </ul>

\* If a +B overcurrent is detected, stoppage of the vertical deflection is detected simultaneously. The symptom that is diagnosed first by the microcontroller is displayed on the screen.

\*\* Refer to Screen (G2) Adjustments in Section 2-4 of this manual

### Display of Standby/Timer LED Flash Count

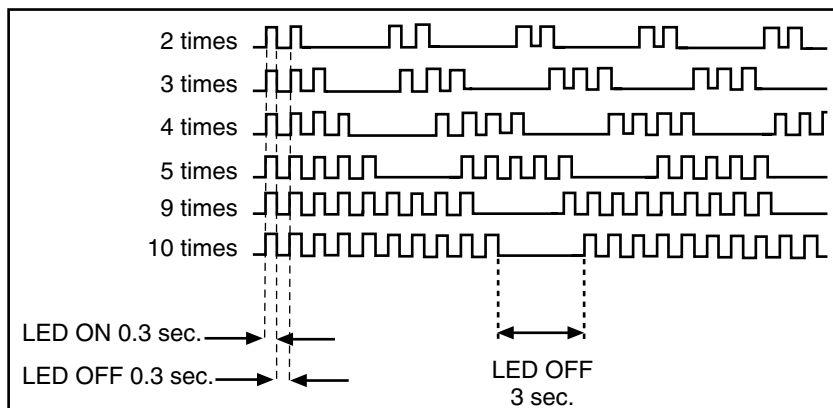

Diagnostic Item	Flash Count*
+B Overcurrent	2 times
+B Overvoltage	3 times
V-STOP	4 times
IK (AKB)	5 times
Zero Cross	9 times
9V	10 times

\*One flash count is not used for self-diagnostic.

### Stopping the Standby/Timer LED Flash

Turn off the power switch on the TV main unit or unplug the power cord from the outlet to stop the STANDBY/TIMER LAMP from flashing.

### Self-Diagnostic Screen Display

For errors with symptoms such as "power sometimes shuts off" or "screen sometimes goes out" that cannot be confirmed, it is possible to bring up past occurrences of failure on the screen for confirmation.

### To Bring Up Screen Test

In standby mode, press buttons on the Remote Commander sequentially, in rapid succession, as shown below:

**DISPLAY** → Channel **5** → Sound volume **0** → Power ON.

SELF DIAGNOSIS	
2: +B OCP	0
3: +B OVP	0
4: VSTOP	0
5: AKB	1
9: ZCD	0
10: 9VON	0
101: WDT	0
Serial: xxxxxxx	
Model: xxxxxxx	

Numeral "0" means that no fault was detected.  
Numerical "1" means a fault was detected one time only.

### Handling of Self-Diagnostic Screen Display

Since the diagnostic results displayed on the screen are not automatically cleared, always check the self-diagnostic screen during repairs. When you have completed the repairs, clear the result display to "0".

Unless the result display is cleared to "0", the self-diagnostic function will not be able to detect subsequent faults after completion of the repairs.

### Clearing the Result Display

To clear the result display to "0", press buttons on the Remote Commander sequentially when the diagnostic screen is displayed, as shown below:

Channel **8** → **ENTER**

### Quitting the Self-Diagnostic Screen

To quit the entire self-diagnostic screen, turn off the power switch on the Remote Commander or the main unit.

### Self-Diagnostic Circuit

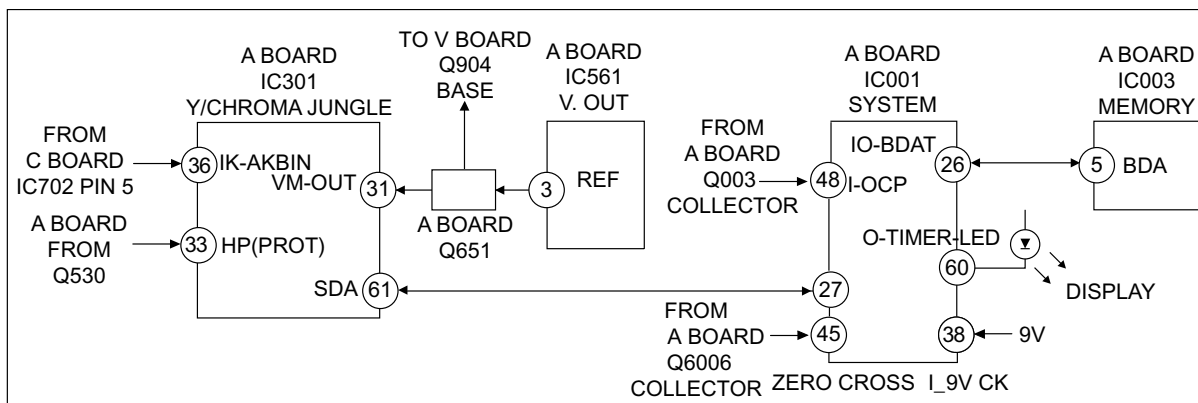

**+B overcurrent (OCP)**

Occurs when an overcurrent on the +B (135V) line is detected by pin 48 of IC001 (A Board). If the voltage of pin 48 of IC001 (A Board) is less than 1V when V.SYNC is more than seven verticals in a period, the unit will automatically turn off.

**+B over voltage (OVP)**

Occurs when a high is felt on pin 2 of IC501 (A Board).

**V-STOP**

Occurs when an absence of the vertical deflection pulse is detected by pin 31 of IC301 (A Board). Power supply will shut down when waveform interval exceeds 2 seconds.

**IK (AKB)**

If the RGB levels\* do not balance within 2 seconds after the power is turned on, this error will be detected by IC301 (A Board). TV will stay on, but there will be no picture.

\*(Refers to the RGB levels of the AKB detection Ref pulse that detects 1K).

**Zero Cross**

Check Q691 collector (GK Board) 7.5V STBY goes to 0V when the set is turned on.

**9V Check**

Check Q691 collector (GK Board) 7.5V STBY goes to 0V when the set is turned on.

# SECTION 1: DISASSEMBLY

## 1-1. REAR COVER REMOVAL

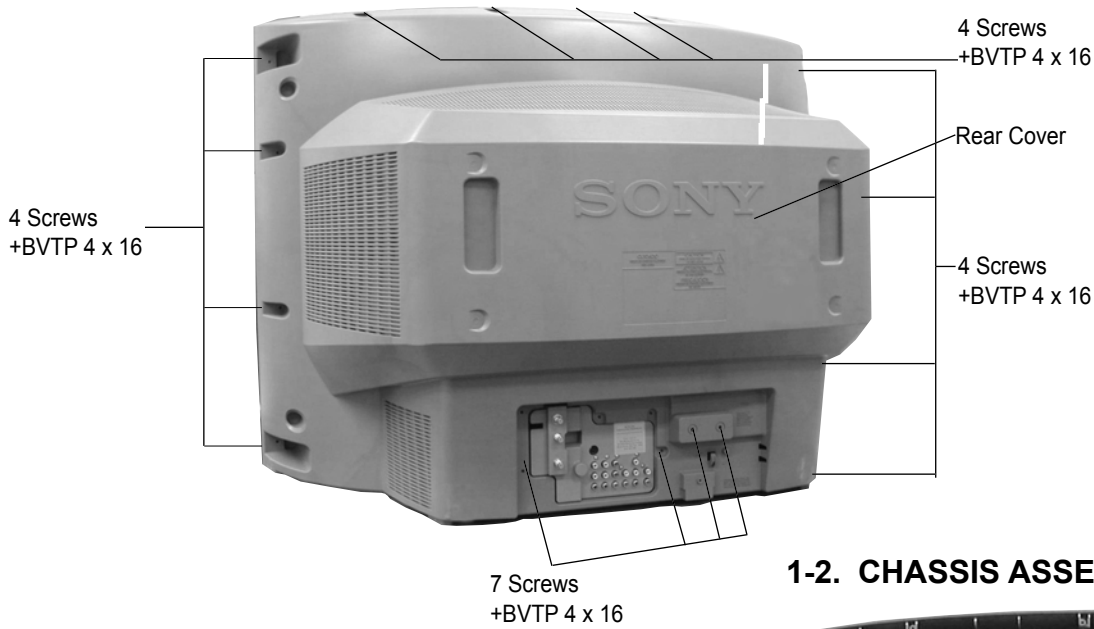

## 1-2. CHASSIS ASSEMBLY REMOVAL

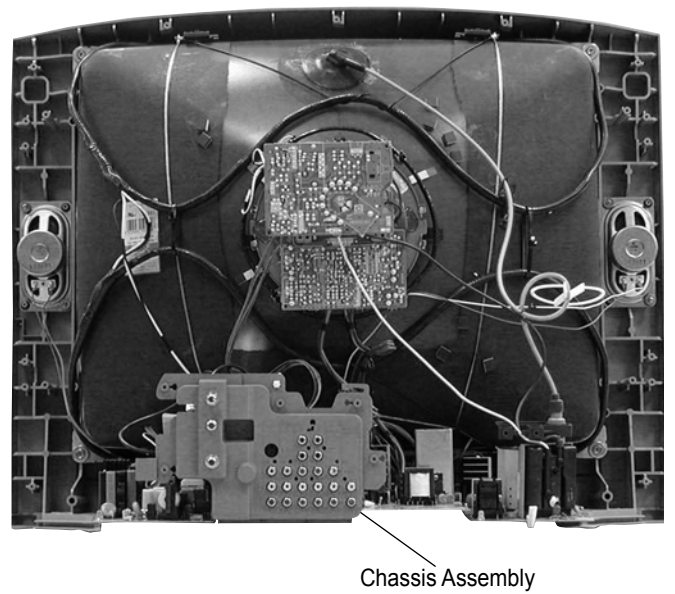

## 1-3. SERVICE POSITION REMOVAL

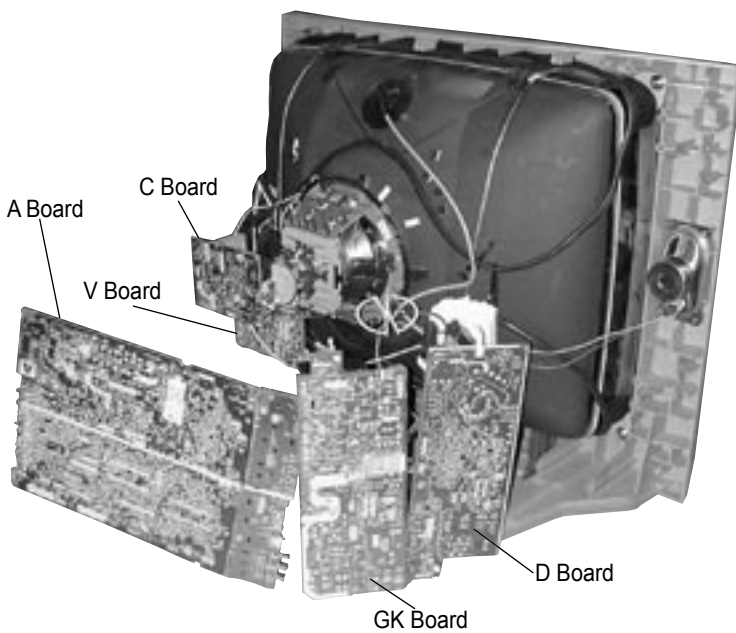

## 1-4. PICTURE TUBE REMOVAL

### WARNING: BEFORE REMOVING THE ANODE CAP

High voltage remains in the CRT even after the power is disconnected. To avoid electric shock, discharge CRT before attempting to remove the anode cap. Short between anode and CRT coated earth ground strap.

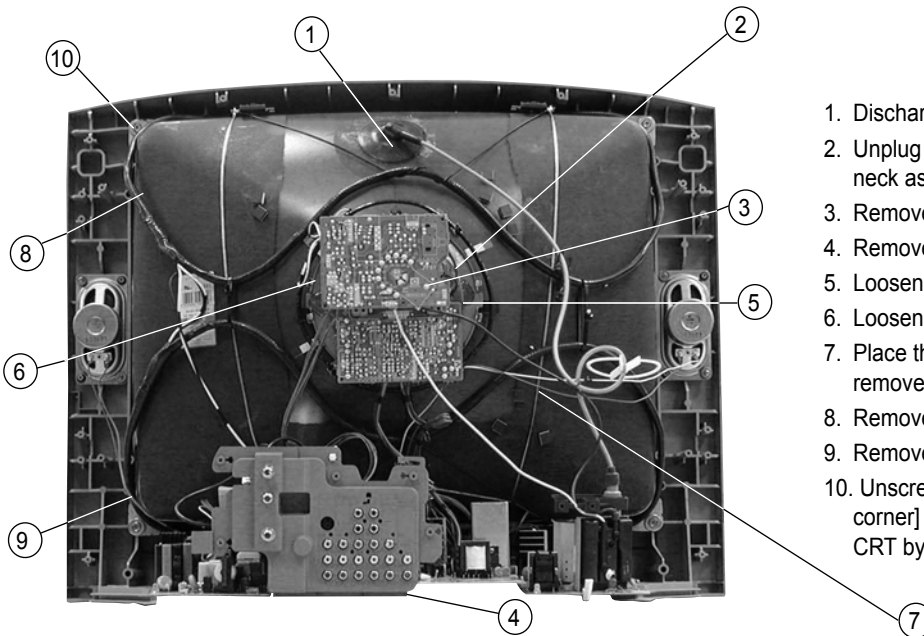
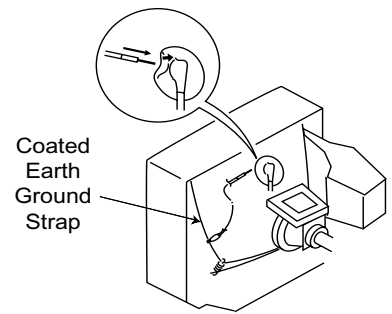

1. Discharge the anode of the CRT and remove the anode cap.
2. Unplug all interconnecting leads from the deflection yoke, neck assembly, degaussing coils and CRT grounding strap.
3. Remove the C Board from the CRT.
4. Remove the chassis assembly.
5. Loosen the neck assembly fixing screw and remove.
6. Loosen the deflection yoke fixing screw and remove.
7. Place the set with the CRT face down on a cushion and remove the degaussing coil holders.
8. Remove the degaussing coils.
9. Remove the CRT grounding strap and spring tension devices.
10. Unscrew the four CRT fixing screws [located on each CRT corner] and remove the CRT [Take care not to handle the CRT by the neck].

## ANODE CAP REMOVAL PROCEDURE

WARNING: High voltage remains in the CRT even after the power is disconnected. To avoid electric shock, discharge CRT before attempting to remove the anode cap. After removing the anode cap, short circuit to either the metal chassis, CRT shield, or carbon painted on the CRT.

NOTE: After removing the anode cap, short circuit the anode of the picture tube and the anode cap to either the metal chassis, CRT shield or carbon painted on the CRT.

### REMOVAL PROCEDURES

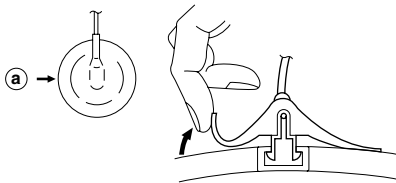

Turn up one side of the rubber cap in the direction indicated by arrow a .

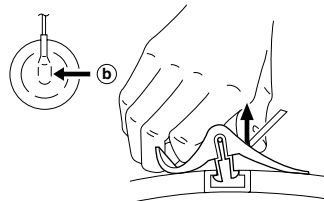

Use your thumb to pull the rubber cap firmly in the direction indicated by arrow b .

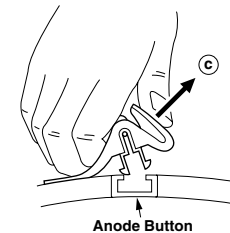

When one side of the rubber cap separates from the anode button, the anode cap can be removed by turning the rubber cap and pulling it in the direction of arrow c .

### HOW TO HANDLE AN ANODE CAP

1. Do not use sharp objects which may cause damage to the surface of the anode cap.
2. To avoid damaging the anode cap, do not squeeze the rubber covering too hard. A material fitting called a shatter-hook terminal is built into the rubber.
3. Do not force turn the foot of the rubber cover. This may cause the shatter-hook terminal to protrude and damage the rubber.

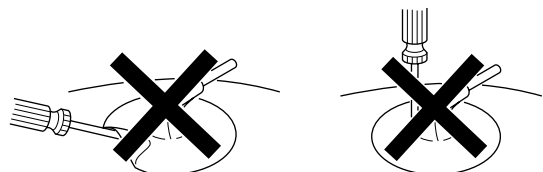

## SECTION 2: SET-UP ADJUSTMENTS

The following adjustments should be made when a complete realignment is required or a new picture tube is installed. These adjustments should be performed with rated power supply voltage unless otherwise noted.

The controls and switch should be set as follows unless otherwise noted:

PICTURE CONTROL: normal  
BRIGHTNESS CONTROL: normal

**Perform the adjustments in order as follows:**

1. Beam Landing
2. Convergence
3. Focus
4. Screen (G2)/White Balance

**Test Equipment Required:**

1. Color Bar Pattern Generator
2. Degausser
3. DC Power Supply
4. Digital Multimeter
5. Oscilloscope
6. CRT Analyzer

### 2-1. BEAM LANDING

#### Preparation:

- Input a white pattern signal.
- Face the picture tube in an East or West direction to reduce the influence of geomagnetism.

**NOTE: Do not use the hand degausser; it magnetizes the CRT .**

#### ADJUSTMENT PROCEDURE

1. Input white pattern from pattern generator.
2. Loosen the deflection yoke mounting screw, and set the purity control to the center as shown below:

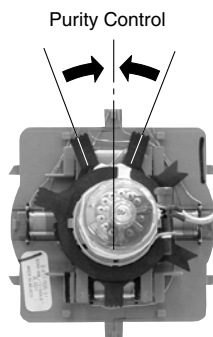

3. Input green pattern from pattern generator.
4. Move the deflection yoke backward, and adjust with the purity control so that green is in the center and red and blue are even on both sides.

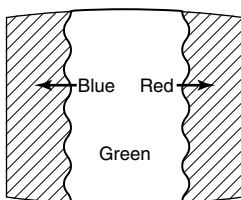

5. Move the deflection yoke forward, and adjust so that the entire screen becomes green.

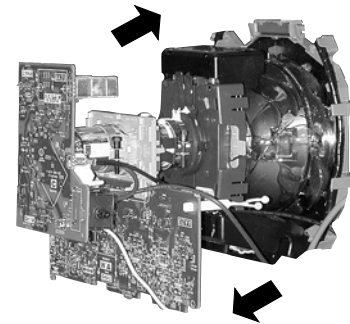

6. Switch over the raster signal to red and blue and confirm the condition.
7. When the position of the deflection yoke is determined, tighten it with the deflection yoke mounting screw.
8. When landing at the corner is not right, adjust by using the disk magnets.

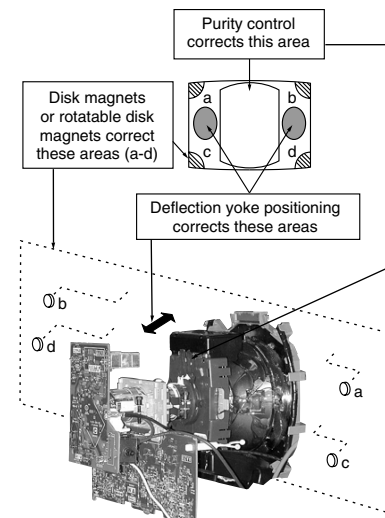



## 2-2. CONVERGENCE

### Preparation:

- Perform FOCUS, V. LIN and V. SIZE adjustments.
- Set BRIGHTNESS control to minimum.
- Input dot pattern.

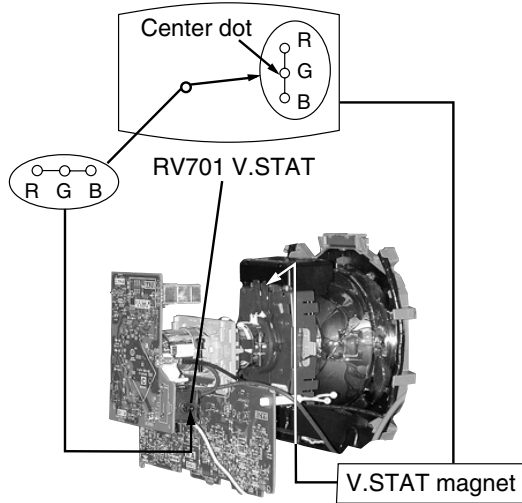

### VERTICAL AND HORIZONTAL STATIC CONVERGENCE

1. Adjust V. STAT magnet to converge red, green and blue dots in the center of the screen (Vertical movement).

Tilt the V. STAT magnet and adjust static convergence to open or close the V. STAT magnet.

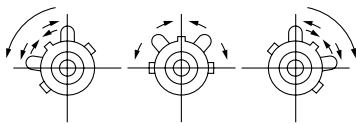

2. When the V. STAT magnet is moved in the direction of arrow a and b, red, green, and blue dots move as shown below:

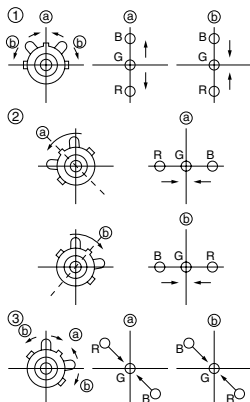

## OPERATION OF BMC (HEXPOLE) MAGNET

The respective dot positions resulting from moving each magnet interact, so perform adjustment while tracking.

- 1 Use the V.STAT tabs to adjust the red, green, and blue dots so they line up at the center of the screen (move the dots in a horizontal direction).

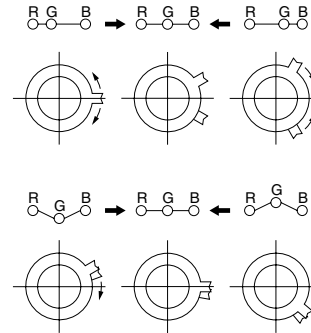

## Y SEPARATION AXIS CORRECTION MAGNET ADJUSTMENT

1. Input cross-hatch pattern, adjust PICTURE to minimum and BRIGHTNESS to normal.
2. Adjust the deflection yoke upright so it touches the CRT.
3. Adjust so that the Y separation axis correction magnet on the neck assembly is symmetrical from top to bottom (open state).

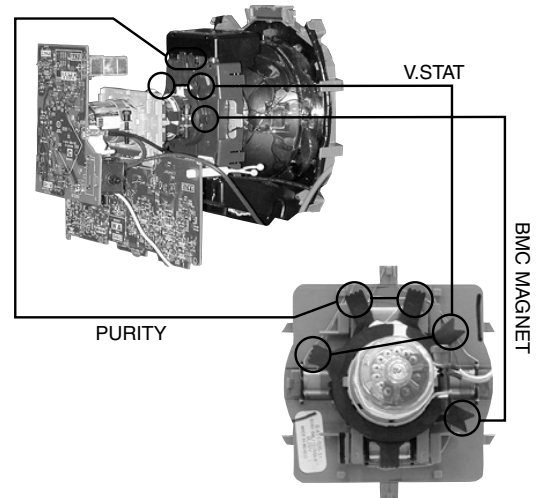

4. Return the deflection yoke to its original position.

## DYNAMIC CONVERGENCE ADJUSTMENT

Before starting, perform Vertical and Horizontal Static Convergence Adjustment.

1. Slightly loosen deflection yoke screw.
2. Remove deflection yoke spacers.
3. Move the deflection yoke for best convergence as shown below:

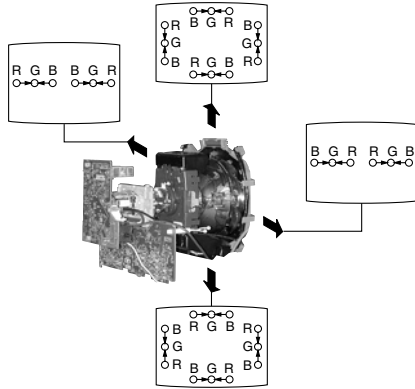

4. Tighten the deflection yoke screw.
5. Install the deflection yoke spacers.

## TLH PLATE ADJUSTMENT

### Preparation:

- Input crosshatch pattern.
- Adjust Picture Quality to standard, Picture and Brightness to 50%, and Other to standard.
- Adjust the Horizontal Convergence of red and blue dots by tilting the TLH plate on the deflection yoke.

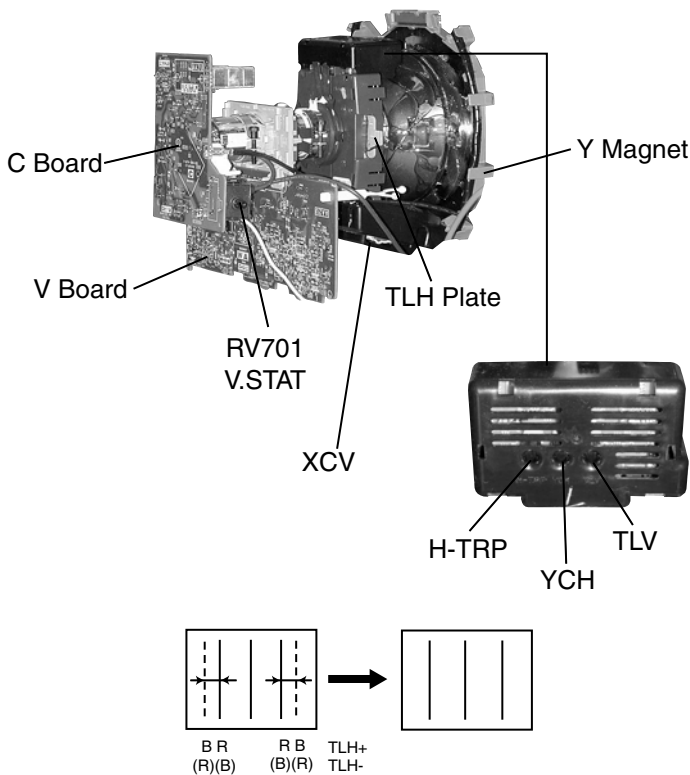

1. Adjust XCV core to balance X axis.
2. Adjust YCH VR to balance Y axis.
3. Adjust vertical red and blue convergence with V.TILT (TLV VR.)  
Perform adjustments while tracking items 1 and 2.
4. Adjust Y MAGNET to correct V.BOW Geometry Distortion.
5. Adjust H-TRP to correct H.Trapezoid Geometry Distortion.

After adjusting items 4 and 5, confirm overall geometry again.

## SCREEN-CORNER CONVERGENCE

1. Affix a permalloy assembly corresponding to the misconverged areas:

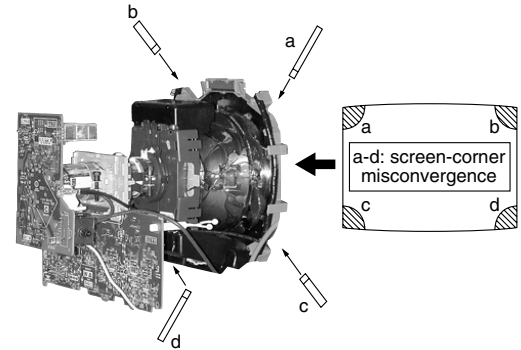

## 2-3. FOCUS

1. Input monoscope signal.
2. Set user controls to normal.
3. Set video mode to STANDARD.
4. Set the PICTURE to maximum.
5. Adjust at 325 Mark for best center/corner focus balance.
6. Receive an entire white signal. Make sure Magenta Ring is at an acceptable level.

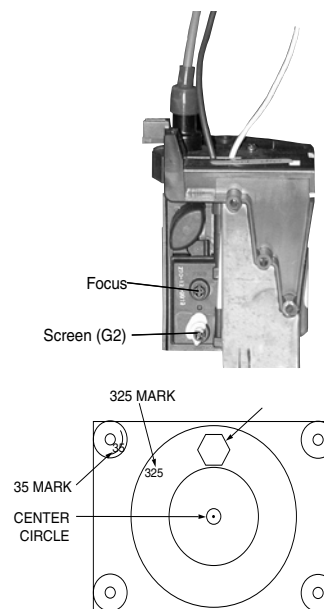

## 2-4. SCREEN (G2)

1. Input dot pattern from the pattern generator.
2. Set the user controls to NORMAL.
3. Attach the G2-Jig to the C Board.
4. Adjust RCUT, GCUT, BCUT, and SBRT in service mode with an oscilloscope so that voltages on the red, green, and blue cathodes are  $170 \pm 4.0$ Vdc.
5. Observe the screen and adjust SCREEN (G2) VR to obtain the faintly visible background of dot signal.
6. Push the TEST + JUMP (+ Channel) to cut off the signal. The screen should be bright or dark. Brightness of raster must be increased when adjusting.
7. Adjust screen VR until the screen is slightly cut off, or scarcely lights up. A signal cannot be seen when the brightness of the raster is high.
8. Push the JUMP again to release the cut off.

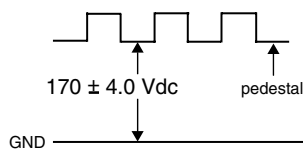

## 2-5. WHITE BALANCE ADJUSTMENTS

Adj.	NO.	Disp.	Item	All Models
VID_ADJ	0	RDRV	Red Drive	41
VID_ADJ	1	GDRV	Green Drive	32
VID_ADJ	2	BDRV	Blue Drive	29
VID_ADJ	3	RCUT	Red Cut-off	31
VID_ADJ	4	GCUT	Green Cut-off	14
VID_ADJ	5	BCUT	Blue Cut-off	17
VP2	4	SBRT	Sub Bright	16

1. Set program palette to STANDARD and push RESET.
2. Input an entire white signal.
3. Set to Service Adjustment Mode.
4. Set the PICTURE and BRIGHT to minimum.
5. Adjust with SBRT if necessary.
6. Set RCUT to "14".
7. Select GCUT and BCUT with **3** and **5**.
8. Adjust by pressing **1** and **4** for the best white balance.
9. Set the PICTURE and BRIGHT to maximum.
10. Select GDRV and BDRV with **1** and **2**.
11. Adjust with **3** and **6** for the best white balance.
12. Write into the memory by pressing **3** then **5**.
13. Repeat steps 1-12 for GDR4, BDR4, GCU4 and BCU4 using Video 4 input.



\* Use values from Sub Contrast Adjustments

**White balance should be adjusted after Sub Contrast because RDRV is also used in Sub Contrast Adjustment. (See page 26)**

## SECTION 3: SAFETY RELATED ADJUSTMENTS

### 3-1. RV8002 CONFIRMATION METHOD (HV HOLD-DOWN CONFIRMATION) AND READJUSTMENTS

Always perform the following adjustments when replacing the following components marked with a  mark on the schematic diagram:

Part Replaced (  )	Adjustment (  )
<b>D BOARD:</b> <b>D8022, IC8001, IC8004, IC8005,</b> <b>IC8104, R8014, R8015, R8016,</b> <b>R8017, R8019, R8021, R8046,</b> <b>R8052, R8072, R8078, R8079,</b> <b>R8082, R8091, R8095</b> <b>GK BOARD:</b> <b>IC601</b>	<b>HV HOLD DOWN</b> <b>RV8002</b>

#### PREPARATION BEFORE CONFIRMATION

Equipment: HV meter, DVM, Analog Current meter.

Condition: AC input voltage: 130 ( $\pm 2$ ) VAC.

Set condition: Reset condition.

Signal Input: All black video signal for Cut off, All white signal for High light.

#### HV PROTECTOR CHECK-CUT OFF CONDITION

1. Remove D board and carefully lift as necessary to gain access to the bottom of the board. Open ABL pin 1 on RHT (T8001) and connect analog current meter.
2. Make Cut Off condition. Input all black video signal and set picture and brightness to min., ABL current should be approximately **0.15  $\pm$  0.05mA for 27/29"** and **0.16  $\pm$  0.05mA for 32/36"**.
3. Short across C8002, C8021 and C8301.
4. Turn off the set and install precision VR jig (initially set to 100K) to IC 8005 pin 1 and GND (C8076 -). Restore power and adjust to obtain **34.6  $\pm$  0.2kV for 27/29"** and **36.0  $\pm$  0.2kV for 32/36"**.
5. Remove short from C8002 and confirm that hold down activates.
6. Short C8002 again and confirm that HV recovers.
7. Then readjust precision VR jig to obtain **31.5  $\pm$  0.2kV for 27/29"** and **32.5  $\pm$  0.2kV for 32/36"**.
8. Remove short from C8002, C8021 and C8301.
9. Confirm that hold down does **not** activate

#### HV PROTECTOR CHECK-HIGH LIGHT CONDITION

1. Short across C8002, C8021, C8301, C8012 and C8015.
2. Open pin 10 (ABL) of IC301 (YCJ).
3. Set video to white field. Set HV current load to **iabl = 2.74  $\pm$  0.05mA for 27/29"** and **iabl = 3.04  $\pm$  0.05mA for 32/36"** by adjusting picture and brightness to maximum condition.
4. Adjust VR jig to obtain **33.10  $\pm$  0.2kV for 27/29"** and **34.25  $\pm$  0.2kV for 32/36"**.
5. Remove short from C8002 and confirm that hold down activates.
6. Short C8002 again and confirm that HV recovers.
7. Then readjust precision VR jig to obtain **31.0  $\pm$  0.2kV for 27/29"** and **32.0  $\pm$  0.2kV for 32/36"**.
8. Remove shorts from C8002, C8021 and C8301.
9. Confirm that hold down does **not** activate.
10. Remove shorts from C8012, C8015.

## SECTION 4: CIRCUIT ADJUSTMENTS

### ELECTRICAL ADJUSTMENTS BY REMOTE COMMANDER

Use the Remote Commander (RM-Y181) to perform the circuit adjustments in this section.

**Test Equipment Required:** 1. Pattern generator 2. Frequency counter 3. Digital multimeter 4. Audio oscillator

#### 4-1. SETTING THE SERVICE ADJUSTMENT MODE

- Standby mode (Power off).
- Press the following buttons on the remote commander within a second of each other:

**DISPLAY** → Channel **5** → Sound Volume **+** → Power

#### SERVICE ADJUSTMENT MODE ON

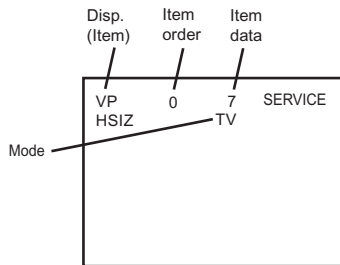

- The CRT displays the item being adjusted.
- Press **1** or **2** on the Remote Commander to select the item.
- Press **3** or **6** on the Remote Commander to change the data.
- Press **MUTING** then **ENTER** to write into memory.

#### SERVICE ADJUSTMENT MODE MEMORY

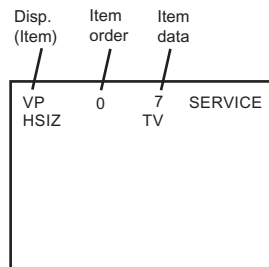

- Press **8** then **ENTER** on the Remote Commander to initialize.

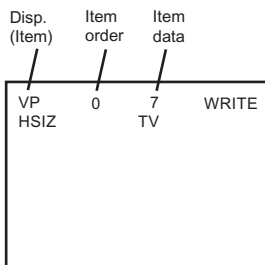

Carry out Step 1 when adjusting ID's 0-7 and when replacing and adjusting IC003.

- Press **MUTING** then **ENTER** to write into memory.
- DO NOT turn off set until SERVICE appears.

#### 4-2. MEMORY WRITE CONFIRMATION METHOD

- After adjustment, pull out the plug from the AC outlet, then replace the plug in the AC outlet again.
- Turn the power switch ON and set to Service Mode.
- Call the adjusted items again to confirm they were adjusted.

#### 4-3. REMOTE ADJUSTMENT BUTTONS AND INDICATORS

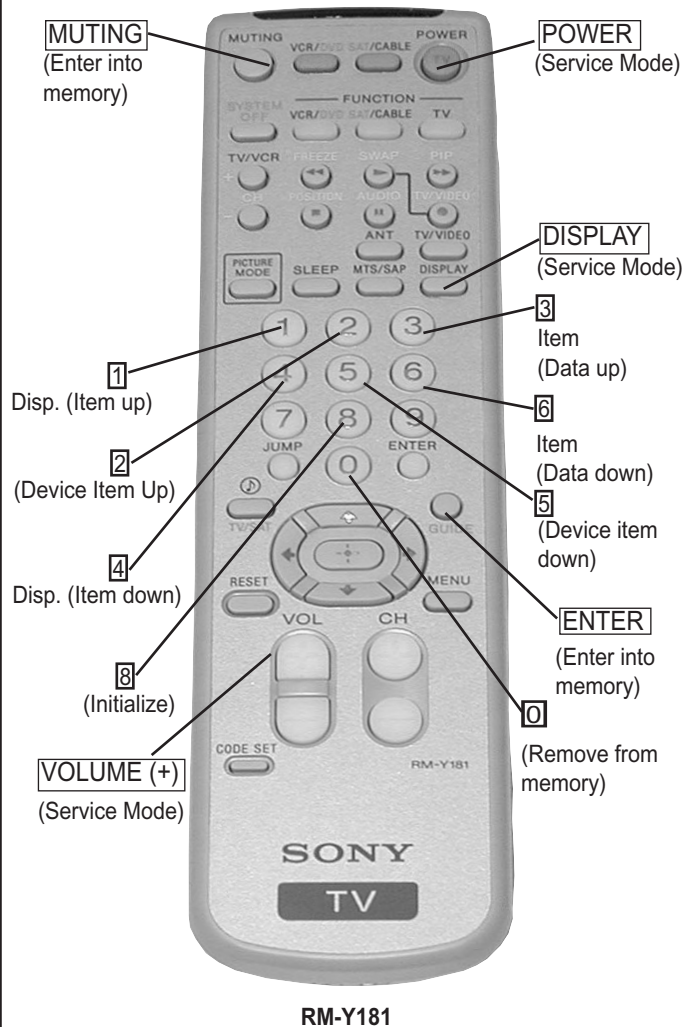

## 4-4. SERVICE DATA LISTS

Service Group	Fix/Var	No.	Name	Description	Common Init Data
VERSION	Fix	0	VER	Microprocessor version information	=

Service Group	Fix/Var	No.	Name	Description	Common Init Data
VP1	Var	0	HSIZ	H SIZE (11 / 2-7)	
	Var	1	HPOS	HPOS (12 / 2-7)	
	Var	2	VBOW	AFC BOW (16 / 4-7)	
	Var	3	VANG	AFC ANGLE (16 / 0-3)	
	Var	4	VTRP	TRAPEZIUM (20 / 3-7)	
	Var	5	HTRP	H. TRAPEZOID (15 / 4-7)	
	Var	6	TROT	TILT ROTATION (0-63)	
	Var	7	PAMP	PIN AMP (13 / 2-7)	
	Var	8	UPIN	UP-CPIN (14 / 2-7)	
	Var	9	LPIN	LO-CPIN (1C / 2-7)	
	Var	10	VSIZ	V SIZE (0E / 2-7)	
	Var	11	VPOS	V POSITION (0E / 2-7)	
	Var	12	VLIN	V LINEARITY (10 / 0-3)	
	Var	13	SCOR	S CORRECTION (10 / 4-7)	
	Fix	14	VZOM	16:9 CRT Z Mode on/off	0
	Var	15	EHT	Vertical High-Voltage Compensation	0
	Fix	16	ASP	Aspect Ratio control (4:3 Mode)	47
	Fix	17	ASP1	Aspect Ratio control (16:9 Mode)	47
	Fix	18	SCRL	16:9 CRT Z Mode Trans. Scroll	31
	Fix	19	HBLK	Horizontal Blanking on/off	1
	Fix	20	LBLK	Left Blanking Adjustment	12
	Fix	21	RBLK	Right Blanking Adjustment	6
	Fix	22	HDW	Horizontal Drive Pulse Width	1
	Fix	23	EWDC	"Parabola" EW, D.C. Adjustment	0
	Fix	24	LVLN	Lower Screen BTM Vertical Line Adj.	0
	Fix	25	UVLN	Upper Screen BTM Vertical Line Adj.	0
	Fix	26	INTL	INTERLACE	0
	Fix	27	HOOSC	Horizontal VCO Oscillation Freq.	7
	Fix	28	VSS	Vertical Sync Slice Level	0
	Fix	29	HSS	Horizontal Sync Slice Level	0
	Fix	30	HMSK	For Macro Vision	0
	Fix	31	VTMS	Select Signal VTIM Pin	0
	Fix	32	TCMD	Vertical Count Down Mode Switching (for TV)	1
	Fix	33	VCMD	Vertical Count Down Mode Switching (for Video)	3
	Fix	34	AFC	AFC Loop Gain Switching	0
	Fix	35	FIFR	Field Frequency	1
	Fix	36	VBLK	VBLKW	0
Fix	37	HTSW	H-Trap Switch : NEW	0	

## SERVICE DATA LISTS

Service Group	Fix/Var	No.	Name	Description	Common Init Data
VP2	Fix	0	REFP	REFP	0
	Fix	1	JPSW	Jump SW	=
	Var	2	SHUE	Sub HUE adjustment	
	Var	3	SCOL	Sub COLOR adjustment	
	Var	4	SBRT	Sub BRIGHTNESS adjustment	
	Fix	5	SBRO	Sub BRIGHTNESS adjustment for YUV	3
	Fix	6	AXPL	Axis PAL	0
	Fix	7	AXNT	Axis NTSC	1
	Fix	8	CBPF	Chroma BPF on/off	1
	Fix	9	CTRP	Y TRAP FILTER on/off	1
	Fix	10	COFF	Color On/off	=
	Fix	11	KOFF	Set Color Killer	0
	Fix	12	SSHR	Sub SHARPNESS for RF	4
	Fix	13	SSHV	Sub SHARPNESS for Video	4
	Fix	14	SHP4	Sub SHARPNESS for YUV	4
	Fix	15	TSPF	SHARPNESS Circuit Fo (for TV)	2
	Fix	16	VSPF	SHARPNESS Circuit Fo (for Video)	3
	Fix	17	PREL	Pre-Shoot/ Over-Shoot	1
	Fix	18	ABLM	ABL Mode Switch	1
	Fix	19	VTH	ABL CD VHT Switching	=
	Fix	20	YDEC	Y Delay Time Control (Video4, SVideo1, SVideo2)	0
	Fix	21	YDYS	Y Delay Time Control (RF, Video1, Video2, Video3)	0
	Fix	22	NCOL	No Color ID	1
	Fix	23	FSC	FSC Out on/off	0
	Fix	24	KID	Killer ID Control on/off	0
Fix	25	SHOF	Offset for sharpness	0	

Service Group	Fix/Var	No.	Name	Description	Common Init Data	NTSC Init Data	PAL-M Init Data	PAL-N Init Data
VID_ADJUSTMENT	Fix	0	RDRV	R DRIVE (0A / 7-2)	41			
	Var	1	GDRV	G DRIVE (0B / 7-2)				
	Var	2	BDRV	B DRIVE (0C / 7-2)				
	Fix	3	RCUT	R CUT OFF ( 07 / 7-2)	31			
	Var	4	GCUT	G CUT OFF (08 / 7-2)				
	Var	5	BCUT	B CUT OFF (09 / 7-2)				
	Var	6	SCON	Sub Contrast adjustment				
	Fix	7	CHUE	Sub HUE adjustment for TV	18			
	Var	8	HUE4	Sub HUE adjustment for YUV				
	Fix	9	CCOL	Sub COLOR adjustment for TV		14	18	23
	Var	10	COL4	Sub COLOR adjustment for YUV				
	Var	11	UOFS	YUV U offset				
	Var	12	VOFS	YUV V offset				
	Fix	13	RON	R ON (01 / 3)	=			
	Fix	14	GON	G ON (01 / 2)	=			
	Fix	15	BON	B ON (01 / 1)	=			
	Var	16	HUEV	Sub HUE adjustment for Video				
Var	17	COLV	Sub COLOR adjustment for Video		7	7	7	

## SERVICE DATA LISTS

Service Group	Fix/Var	No.	Name	Description	Common Init Data
ENCODER	Fix	0	RDR4	R DRIVE (0A / 7-2)	41
	Var	1	GDR4	G DRIVE (0B / 7-2)	
	Var	2	BDR4	B DRIVE (0C / 7-2)	
	Fix	3	RCU4	R CUT OFF ( 07 / 7-2)	31
	Var	4	GCU4	G CUT OFF (08 / 7-2)	
	Var	5	BCU4	B CUT OFF (09 / 7-2)	
	Fix	6	CON4	Sub Contrast adjustment	12
	Fix	7	EHUE	Sub HUE adjustment for TV	28
	Fix	8	ECOL	Sub COLOR adjustment for TV	31
	Fix	9	HPO4	HPOS (12 / 2-7)	
	Fix	10	CDL4	Encoder CDL 3D Register	6
	Fix	11	YNR4	Encoder YNRL 3D Register	1
	Fix	12	CNR4	Encoder CNRL 3D Register	1
	Fix	13	NRM4	Encoder VAPG 3D Register	3
	Fix	14	VAP4	Encoder NRMD 3D Register	3
	Var	15	ESHU	Sub HUE adjustment for Video	10
	Var	16	ESCO	Sub COLOR adjustment for Video	9
	Fix	17	HCN4	Encoder HCNT 3D Register	0
	Fix	18	YPGE	Encoder YPGE 3D Register	9

Same as HPOS + 1

Service Group	Fix/Var	No.	Name	Description	Common Init Data
COL_TMP	Fix	0	GDOF	G DRIVE Offset	4
	Fix	1	BDOF	B DRIVE Offset	15
	Fix	2	GCOF	G CUT Offset	5
	Fix	3	BCOF	B CUT Offset	12
	Fix	4	DCOL	Dynamic Color	=

Service Group	Fix/Var	No.	Name	Description	Common Init Data
PIC_IMP	Fix	0	BLAD	Black area detect (01 / 6-7)	0
	Fix	1	SRTS	SRT level (01 / 4-5)	3
	Fix	2	YNR	YNR(01 / 2)	1
	Fix	3	GIRE	Gamma correction(01 / 0-1)	3
	Fix	4	DAC1	DAC1(02 / 7)	0
	Fix	5	DAC2	DAC2(02 / 6)	0
	Fix	6	VMGA	VM on 1226 (02/5-4)	0
	Fix	7	GCUR	Gamma curve(02 / 2)	1
	Fix	8	BLKC	Black Compensation (02 / 1)	1
	Fix	9	TEST	TEST(03 / 6-7)	3
	Fix	10	RS	RS (03 / 3-5)	0
	Fix	11	RTCH	RTC(03 / 0-2)	3
	Fix	12	RTCL	RTC(03 / 0-2)	3
	Fix	13	RTCO	RTC(03 / 0-2)	0
	Fix	14	APAH	APAC	0
	Fix	15	APAL	APAC	1
	Fix	16	APAO	APAC	1
	Fix	17	SRTH	SRT bit for Dynablack = High	1
	Fix	18	SRTL	SRT bit for Dynablack = Low	1
	Fix	19	SRTO	SRT bit for Dynablack = Off	0
	Fix	20	SHPH	Sharpness level for Dynablack = High	57
	Fix	21	SHPL	Sharpness level for Dynablack = Low	52
Fix	22	SHPO	Sharpness level for Dynablack = Off	0	



## SERVICE DATA LISTS

Service Group	Fix/Var	No.	Name	Description	VIVID Init Data	STANDARD	MOVIE	PRO
						Init Data	Init Data	Init Data
PALETTE	Fix	0	VPIC	User picture setting 0:min, 63: max	63	50	38	31
	Fix	1	VBRT	User brightness setting 0:min, 63: max	26	29	35	31
	Fix	2	VCOL	User color setting 0:min, 63: max	35	31	31	31
	Fix	3	VSHR	User sharpness setting 0:min, 63: max	31	33	31	31
	Fix	4	VVM	0: OFF, 1: Low, 2: High, 3: N/A	2	1	0	0
	Fix	5	VTRI	0: Cool, 1: Neutral, 2: Warm, 3: N/A	0	1	2	1
	Fix	6	VGMA	0: OFF, 1: Low, 2: Mid, 3: Max	2	1	0	0
	Fix	7	VNRM	0: 3D, 1: 2D	0	0	0	0
	Fix	8	VYDC	DC Transmission Ratio 0,1: 100%, 2: 92%, 3: 85	3	2	1	1
	Fix	9	VVEN	Vertical; Enhancement	4	3	3	0
	Fix	10	VHK0	Horizontal Peaking 0:On, 1:Off	0	0	0	1
	Fix	11	VDBK	User Dynablack 0: OFF, 1: Low, 2: High, 3: N/A	2	1	1	0
Fix	12	VYPL	Y-Peaking Limit	1	0	0	0	

Service Group	Fix/Var	No.	Name	Description	Common Init Data
3L_COMB	Fix	0	FUNN	Function (0 / 7-6) for NTSC	3
	Fix	1	FUNP	Function (0 / 7-6) for PALM, PALN	3
	Fix	2	DRNG	DRANG (0 / 2)	0
	Fix	3	YCSM	Y/C Sep Mode (0 / 1-0)	0
	Fix	4	CNRK	CNRK (1 / 7-6)	1
	Fix	5	CNRL	CNR Lim (1 / 5-4)	1
	Fix	6	CLPF	C-LPF(1 / 3)	1
	Fix	7	SLPF	SelC-LPF(1 / 2)	0
	Fix	8	MODE	Mode1 (1 / 1)	0
	Fix	9	YPG	Y - Peaking Gain (2 / 7-6)	3
	Fix	10	PDSC	Pds. Clip (2 / 3)	0
	Fix	11	YLPF	Y-LPF(2 / 2)	1
	Fix	12	VENL	V-Emph N.L (3 / 4-2)	4
Fix	13	VEC	V - Emph Core (3 / 1-0)	3	

## SERVICE DATA LISTS

Service Group	Fix/ Var	No.	Name	Description	Common Init Data
3D_COMB	Fix	0	COU	COUTS(00 / 2-3)	3
	Fix	1	YAP	YAPS(00 / 0-1)	1
	Fix	2	NSD	NSDS(01 / 4-5)	0
	Fix	3	MSS	MSS(01 / 2-3)	0
	Fix	4	KIL	KILS (01 / 1-0)	1
	Fix	5	DY	DYCOS ( 02 / 7-6)	2
	Fix	6	EX	EXADINS(02 / 5)	0
	Fix	7	EX	EXCSS(02 / 1-0)	1
	Fix	8	CPP	CPP(03 / 6)	0
	Fix	9	HDP	HDP(03 / 3-5)	6
	Fix	10	CD	CDL(03 / 0-2)	6
	Fix	11	DY	DYCOR(04 / 4-7)	2
	Fix	12	DY	DYGAIN(04 / 0-3)	10
	Fix	13	DCC	DCCOR(05 / 4-7)	2
	Fix	14	DCG	DCGAIN(05 / 0-3)	9
	Fix	15	YN	YNRLIM(06 / 4-5)	1
	Fix	16	CN	CNRLIM(06 / 0-1)	1
	Fix	17	ID	ID1ON(07 / 7)	0
	Fix	18	ID	ID1W0A1(07 / 6)	0
	Fix	19	ID	ID1W0A2(07 / 5)	0
	Fix	20	WSC	WSC(08 / 6-7)	1
	Fix	21	VTR	VTRH(08 / 4-5)	1
	Fix	22	VTR	VTRR(08 / 2-3)	1
	Fix	23	LDS	LDSR(08 / 0-1)	2
	Fix	24	WSS	WSS ( 09 / 7 )	0
	Fix	25	ID	ID1ECON ( 09 / 6 )	1
	Fix	26	TT	TT ( 09 / 4 -5)	0
	Fix	27	FEL	FELCHK ( 09 / 3 )	1
	Fix	28	TH	TH ( 09 / 1 -2)	0
	Fix	29	VAP	VAPGAIN(0A / 5-7)	3
	Fix	30	VAP	VAPINV(0A / 0-4)	25
	Fix	31	YP	YPFT(0B / 4-5)	3
	Fix	32	YP	YPFG(0B / 0-3)	9
	Fix	33	V1	V1PS(0C / 6-7)	3
	Fix	34	VEG	VEGS(0C / 4-5)	2
	Fix	35	CC	CC3N(0C / 3)	0
	Fix	36	C0	C0HS(0C / 2)	0
	Fix	37	SEL	SELD2FH(0C / 0)	1
	Fix	38	SEL	SELD1FL(0D / 5)	1
	Fix	39	YHC	YHCOR(10 / 6-7)	0
	Fix	40	YHC	YHCGAIN(10 / 5)	1
	Fix	41	OV	+OVST(10 / 3)	0
	Fix	42	CS	CSHDT(10 / 2)	0
	Fix	43	KCT	KCTT(10 / 0-1)	0
	Fix	44	SHT	SHT(11 / 7-6 )	0
	Fix	45	VCT	VCT(11 / 5)	0
	Fix	46	CG	CLKGAT ( 11 / 4)	0
	Fix	47	CG	CLK2D ( 11 / 3)	1
	Fix	48	CG	CLKGGT ( 11 / 2)	0
	Fix	49	CG	CLKGEB ( 11 / 1)	0
	Fix	50	CG	CLKGT ( 11 / 0)	0
	Fix	51	HPL	HPLLFS(12 / 7)	1
	Fix	52	BPL	BPLLFS (12 / 6)	0
	Fix	53	FSC	FSCFG(12 / 5)	0
	Fix	54	PLL	PLLFG(12 / 4)	1

## SERVICE DATA LISTS

Service Group	Fix/Var	No.	Name	Description	Common Init Data
3D_COMB	Fix	55	KILR	KILR(12 / 0-3)	3
	Fix	56	HSSL	HSSL(13 / 4-7)	12
	Fix	57	VSSL	VSSL(13 / 0-3)	8
	Fix	58	BGPS	BGPS(14 / 4-7)	4
	Fix	59	BGPW	BGPW(14 / 0-3)	10
	Fix	60	ADCL	ADCLKS(15 / 6-7)	3
	Fix	61	NSDW	NSDSW(15 / 4)	1
	Fix	62	HIZE	HIZEN ( 16 / 4)	0
	Fix	63	HCNT	HCNTFSYN ( 17 / 6)	0

Service Group	Fix/Var	No.	Name	Description	Common Init Data
PIP	Fix	0	PFRN	VCXO oscillation	0
	Fix	1	PRVS	HD/VD input synchronous mode selection	1
	Fix	2	PCON	PIP sub contrast control	97
	Fix	3	PUCO	PIP U level control	5
	Fix	4	PVCO	PIP V level control	17
	Fix	5	PHUE	PIP sub hue control	12
	Fix	6	PKIL	Color killer	0
	Fix	7	PSEP	C-sync sep input selection	1
	Fix	8	PDCN	Sub pic sync sep. Threshold setting	3
	Fix	9	PBGS	bgp position setting	15
	Fix	10	PDL0	Y/C delay adjust (for video)	11
	Fix	11	PDL1	Y/C delay adjust (for yuv)	13
	Fix	12	PBRT	Y brightness control	25
	Fix	13	PVP1	V pedestal level for YUV	0
	Fix	14	PUP1	U pedestal level for YUV	0
	Fix	15	PVP2	V pedestal level for main w/ burst	0
	Fix	16	PUP2	U pedestal level for main w/ burst	0
	Fix	17	PVP3	V pedestal level for main w/o burst	0
	Fix	18	PUP3	U pedestal level for main w/o burst	0
	Fix	19	PACS	0D, 0Eh setting mode	1
	Fix	20	PSYS	Color system	=
	Fix	21	PSDL	Sync delay control	0
	Fix	22	PCCL	YUV color level	11
	Fix	23	PCGA	Croma gain	1
	Fix	24	PAAF	Auto AFC	1
	Fix	25	PSU2	For test	0
	Fix	26	PCVF	Internal 1H comb filter	0
	Fix	27	PBIT	Y clamp time constant	0
	Fix	28	PAFC	AFC time constant	0
	Fix	29	PACC	Color decoder amplitude	21
	Fix	30	PSDT	System automatic judgment	=
	Fix	31	PBUR	VCXO mode selection	0
	Fix	32	PEVE	Main picture PAL-N	0
	Fix	33	PINW	Invert sub picture field definition	0
	Fix	34	PINR	Invert main picture field definition	0
	Fix	35	PVMD	Vertical display mode when pal-n	=
	Fix	36	PREF	Main picture field fix	0
	Fix	37	PARE	Automatic 50/60 Hz judgment	0
	Fix	38	PBWD	BW det. Threshold setting	1
Fix	39	PFRA	Freq. Adjustment for free run mode	0	

## SERVICE DATA LISTS

Service Group	Fix/Var	No.	Name	Description	Common Init Data
P.P	Fix	40	PPAL	Parameter setting for PAL-M judgment	52
	Var	41	PHPO	Sub picture h position	
	Fix	42	PVPO	Sub picture v position	22
	Fix	43	PHTI	Display timing adjust	6
	Fix	44	PHAJ	Main/Sub switch delay control	2
	Fix	45	PBGY	Back ground Y level setting	0
	Fix	46	PCRO	Sub picture read mode	0
	Fix	47	PPAR	Threshold control for ident judgment of sub	1
	Fix	48	PHPF	Y output HPF	0
	Fix	49	PFSC	FSC output	0
	Fix	50	PVCH	15h,16h,17h, setting mode	0
	Fix	51	PVON	V-chip decode mode	1
	Fix	52	PVLN	V-chip data slicer line selection	17
	Fix	53	PVSB	V-chip data slicer start bit detection parameter	64
	Fix	54	PVLV	V-chip data slicer slice parameter	130
	Fix	55	SUSW	Sub-Unlock bit position switch	0
	Fix	56	PDL5	YDL by when PALN system	0
	Fix	57	PHT5	HT by when PALN system	15

Service Group	Fix/Var	No.	Name	Description	27FV Init Data	32/36FV Init Data
AP	Fix	0	SBAL	Sub Balance	4	4
	Fix	1	SBAS	Sub Bass	2	0
	Fix	2	STRE	Sub Treble	0	0
	Fix	3	SRL	Surround level	0	0
	Fix	4	BBOH	Surround Off - BBE high	6	6
	Fix	5	BBOL	Surround Off - BBE low	8	10
	Fix	6	BBSH	Simulated - BBE high	3	3
	Fix	7	BBSL	Simulated - BBE low	4	4
	Fix	8	BBMH	da	0	0
	Fix	9	BBML	Surround - BBE low	0	0
	Fix	10	BBGH	WOW - BBE high	7	7
	Fix	11	BBGL	WOW - BBE low	9	12
	Fix	12	BBTH	Trusurround - BBE high	5	6
	Fix	13	BBTL	Trusurround - BBE low	9	12
	Fix	14	VFIX	Audio output fix data	255	255
	Fix	15	AGCL	AGC Level	2	2
	Fix	16	BTAB	Bass/Treble curve selection	1	1

## SERVICE DATA LISTS

Service Group	Fix/Var	No.	Name	Description	Common Init Data
CCD	Fix	0	DUM0	Only for testing	=
	Fix	1	VOSD	Only for testing	=

Service Group	Fix/Var	No.	Name	Description	Common Init Data
OP	Var	0	DISP	OSD Display position	
	Fix	1	RAMW		=
	Fix	2	ICMP	Comparison data to determine Non-interlace signal for OSD	4
	Fix	3	IPOR	0:Even, 1: Odd, Other: do not change	1
	Fix	4	FAWD	1: Forced to auto wide mode, 0:normal	0
	Fix	5	HCLW	H-Count Lower limit	67
	Fix	6	HCHG	H-Count Higher limit	254
	Fix	7	9VTM	Delay for 9V check subsystem	55
	Fix	8	ZDET	Zero detect relay delay	123

Service Group	Fix/Var	No.	Name	Description	Common Init Data
ID	Fix	0	ID0	Model variation ID0	SEE ID MAP
	Fix	1	ID1	Model variation ID1	SEE ID MAP
	Fix	2	ID2	Model variation ID2	SEE ID MAP
	Fix	3	ID3	Model variation ID3	SEE ID MAP
	Fix	4	ID4	Model variation ID4	SEE ID MAP
	Fix	5	ID5	Model variation ID5	SEE ID MAP
	Fix	6	ID6	Model variation ID6	SEE ID MAP
	Fix	7	ID7	Model variation ID7	SEE ID MAP

## 4-5. ID MAP TABLE

Model	Destination	ID-0	ID-1	ID-2	ID-3	ID-4	ID-5	ID-6	ID-7
KV-27FV310	USA	89	191	237	98	78	192	6	17
KV-27FV310	CND	89	191	237	82	78	192	6	17
KV-29FV310	LATIN NORTH	81	191	237	194	110	192	6	81
KV-29FV310	LATIN SOUTH	81	191	237	194	110	192	6	81
KV-32FV310	USA	89	191	237	98	78	192	6	17
KV-32FV310	CND	89	191	237	82	78	192	6	17
KV-36FV310	USA	89	191	237	98	78	192	6	17
KV-36FV310	CND	89	191	237	82	78	192	6	17
KV-36FV310	HAWAII	89	191	237	98	78	192	6	17

## 4-6. A BOARD ADJUSTMENTS

### H. FREQUENCY (FREE RUN) CHECK

1. Input a TV mode (RF) with no signal.
2. Connect a frequency counter to base of Q501 (TP-25 H. DRIVE) on the A Board.
3. Check H. Frequency for  $15734 \pm 400/200$  Hz.

### V. FREQUENCY (FREE RUN) CHECK

1. Select video 1 with no signal input.
2. Set the conditions for a standard setting.
3. Connect the frequency counter to TP-27 (V OUT) or CN501 pin ⑥ (V DY+) and ground on the A Board .
4. Check that V. Frequency shows  $60 \pm 4$  Hz.

### SUBCONTRAST ADJUSTMENT (RDRV)

1. Input a color-bar signal and set the level to 75%.
2. Set in Pro mode.
3. Activate the Service Adjustment Mode.
4. Set GON and BON items. Using **[3]** and **[6]** set each to the following values. Leave RON set to "1".

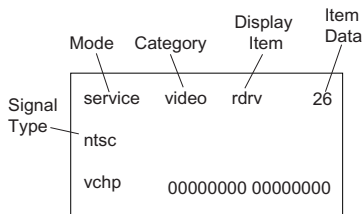

R ON: ON (1)  
G ON: OFF (0)  
B ON: OFF (0)

5. Select SCON with **[1]** and **[4]**.
6. Connect an oscilloscope probe to C Board, CN705 Pin③ Blue Out.
7. Adjust the value of SCON with **[3]** and **[6]** for  $1.90 \pm 0.01V_{pp}$ .

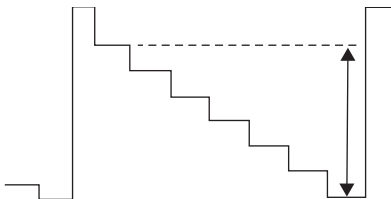

8. Reset GON and BON values to "1".  
R ON: ON (1)  
G ON: ON (1)  
B ON: ON (1)
9. Press **[MUTING]** then **[ENTER]** to save into the memory.
10. After adjusting SCON, if still out of xpec, use RDRV resistor as a fine adjustment.

### DISPLAY POSITION ADJUSTMENT (DISP)

1. Input a color-bar signal.
2. Set to Service Adjustment Mode.
3. Select DISP with **[1]** and **[4]**.
4. Adjust values of DISP with **[3]** and **[6]** to adjust characters to the center.
5. Write to memory by pressing **[MUTING]** then **[ENTER]**.
6. Check to see if the text is displayed on the screen.

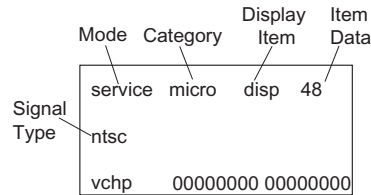

### SUB BRIGHT ADJUSTMENT (SBRT)

1. Input a monoscope signal.
2. Activate the Service Adjustment Mode.
3. Set the PICTURE and BRIGHTNESS to minimum.
4. Select the SBRT item with **[1]** and **[4]**.
5. Adjust the values of SBRT with **[3]** and **[6]** to obtain a faintly visible crosshatch.
6. Press **[MUTING]** then **[ENTER]** to save into the memory.

### SUB HUE, SUB COLOR ADJUSTMENT (SHUE, SCOL)

#### [RF], [VIDEO] [VIDEO MODE PRO]

1. Input color-bar signal at 75%.
2. Set screen to Pro Mode.
3. Activate the Service Adjustment Mode.
4. Set (PIC) to 100% and (COL) to 50%.
5. Connect an oscilloscope probe to C Board, CN705 Pin ④ Blue Out.
6. Select the SHUE and SCOL item with **[1]** and **[4]**.
7. While showing the SHUE item, adjust the waveform with **[1]** and **[4]** until the second and third bars show the same level ( $V_2 = V_3 \pm 0.2V_{pp}$ ).
8. While showing the SCOL item, adjust the waveform with **[3]** and **[6]** until the first and fourth bars show the same level ( $V_1 = V_4 \pm 0.2V_{pp}$ ).
9. For Trinorma models inspect each system NTSC, PAL M & N.

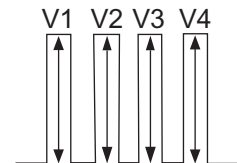

10. Press **[MUTING]** then **[ENTER]** to save into the memory.

## [YUV] [VIDEO MODE PRO]

1. Input color-bar signal at 75%.
2. Set screen to Pro Mode.
3. Activate the Service Adjustment Mode.
4. Set (PIC) to 100% and (COL) to 50%.
5. Connect an oscilloscope probe to C Board, CN705 Pin ④ Blue Out.
6. Select the SHUE and SCOL item with **[1]** and **[4]**.
7. While showing the SHUE item, adjust the waveform with **[1]** and **[4]** until the second and third bars show the same level ( $V2 = V3 \pm 0.2V_{pp}$ ).
8. While showing the SCOL item, adjust the waveform with **[3]** and **[6]** until the first and fourth bars show the same level ( $V1 = V4 \pm 0.2V_{pp}$ ).

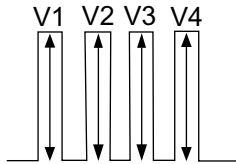

9. Press **[MUTING]** then **[ENTER]** to save into the memory.

## [YUV] [VIDEO MODE VIVID]

1. Input color-bar signal at 75%.
2. Set screen to Vivid Mode.
3. Activate the Service Adjustment Mode.
4. Set (PIC) to 100% and (COL) to 50%.
5. Connect an oscilloscope probe to C Board, CN705 Pin ④ Blue Out.
6. Select the SHUE and SCOL item with **[1]** and **[4]**.
7. While showing the SHUE item, adjust the waveform with **[1]** and **[4]** until the second and third bars show the same level ( $V2 = V3 \pm 0.2V_{pp}$ ).
8. While showing the SCOL item, adjust the waveform with **[3]** and **[6]** until the first and fourth bars show the same level ( $V1 = V4 \pm 0.2V_{pp}$ ).

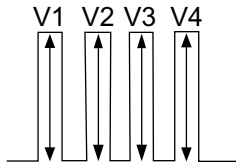

9. Press **[MUTING]** then **[ENTER]** to save into the memory.

## V. SIZE ADJUSTMENT (VSIZ)

1. Input a crosshatch signal.
2. Activate the Service Adjustment Mode.
3. Select the VSIZ item with **[1]** and **[4]**.
4. Adjust value of VPOS with **[1]** and **[4]** for the best vertical center.
5. Press **[MUTING]** then **[ENTER]** to save into the memory.

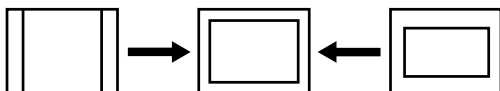

## V. CENTER ADJUSTMENT (VPOS)

Perform this adjustment after performing H. Frequency (Free Run) Check.

1. Input a crosshatch signal.
2. Activate the Service Adjustment Mode.
3. Select the VPOS item with **[1]** and **[4]**.
4. Adjust value of VPOS with **[3]** and **[6]** for the best vertical center.
5. Press **[MUTING]** then **[ENTER]** to save into the memory.

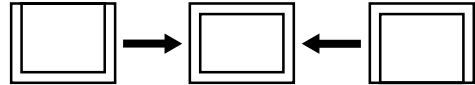

## H. CENTER ADJUSTMENT (HPOS)

Perform this adjustment after performing H. Frequency (Free Run) Check.

1. Input a crosshatch signal.
2. Activate the Service Adjustment Mode.
3. Select the HPOS item with **[1]** and **[4]**.
4. Adjust the value of HPOS with **[3]** and **[6]** for the best horizontal center.
5. Press **[MUTING]** then **[ENTER]** to save into the memory.

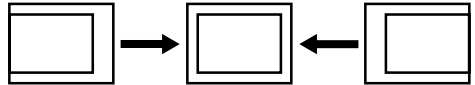

## H. SIZE ADJUSTMENT (HSIZ)

1. Input a monoscope signal.
2. Activate the Service Adjustment Mode.
3. Select HSIZ with **[1]** and **[4]**.
4. Adjust with **[3]** and **[6]** for the best horizontal size.
5. Press **[MUTING]** then **[ENTER]** to save into the memory.

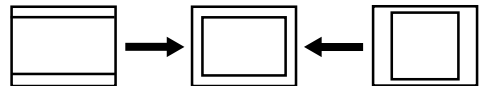

## V. LINEARITY (VLIN), V. CORRECTION (SCOR), PIN AMP (PAMP), AND HORIZONTAL TRAPEZOID (HTRP) ADJUSTMENTS

1. Input a crosshatch signal.
2. Activate the Service Adjustment Mode.
3. Select VLIN, SCOR, PAMP, and HTRP with **1** and **4**.
4. Adjust with **3** and **6** for the best horizontal size.
5. Press **MUTING** then **ENTER** to save into the memory.

V LINEARITY (VLIN)

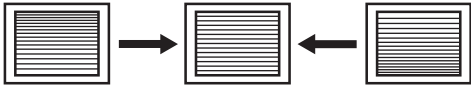

V CORRECTION (SCOR)

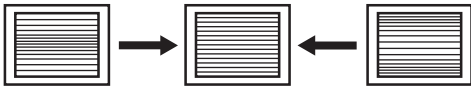

PIN AMP (PAMP)



HORIZONTAL TRAPEZOID (HTRP)



## V. ANGLE (VANG), V. BOW (VBOW), UPPER PIN (UPIN) AND LOW PIN (LPIN) ADJUSTMENTS

1. Input a crosshatch signal.
2. Activate the Service Adjustment Mode.
3. Select VANG, VBOW, UPIN, and LPIN with **1** and **4**.
4. Adjust with **3** and **6** for the best picture.
5. Press **MUTING** then **ENTER** to save into the memory.

V ANGLE (VANG)

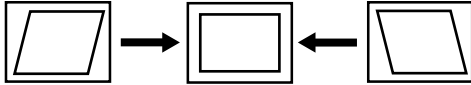

V BOW (VBOW)

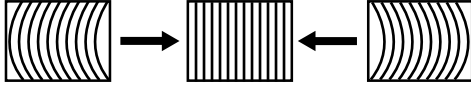

UPPER PIN (UPIN)

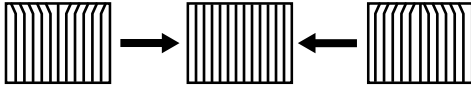

LOW PIN (LPIN)

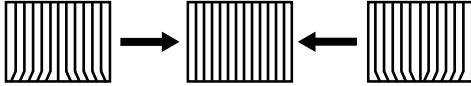

## SERVICE ADJUSTMENT MODE MEMORY

1. After completing all adjustments, press **0** then **ENTER**.

Read From Memory

Signal Type	Mode	Category	Display Item	Item Data
ntsc	service	defl	vbow	7
vchp	00000000	00000000		



## SECTION 5: DIAGRAMS

### 5-1. CIRCUIT BOARDS LOCATION

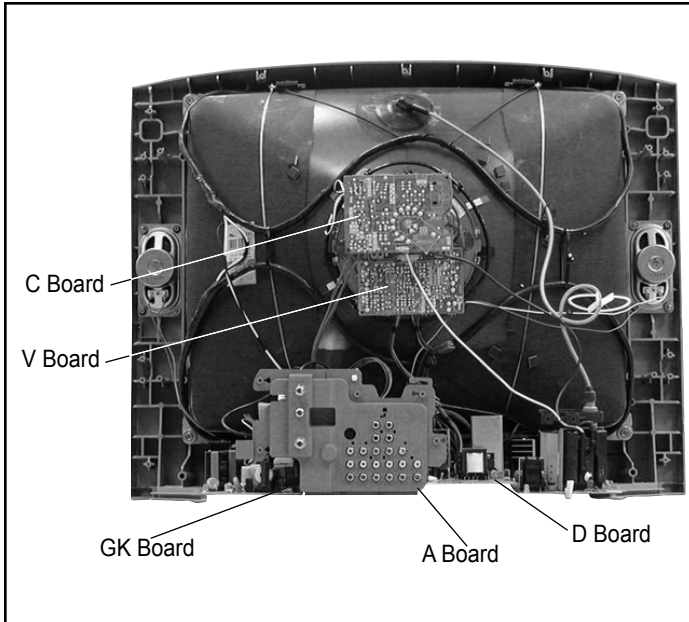

### 5-2. PRINTED WIRING BOARD AND SCHEMATIC DIAGRAM INFORMATION

All capacitors are in  $\mu\text{F}$  unless otherwise noted.  $\text{pF}$  :  $\mu\text{F}$  50V or less are not indicated except for electrolytics and tantalums.

All electrolytics are in 50V unless otherwise specified.

All resistors are in ohms.  $\text{k}\Omega=1000\Omega$ ,  $\text{M}\Omega=1000\text{k}\Omega$

Indication of resistance, which does not have one for rating electrical power, is as follows:

Pitch : 5mm

Rating electrical power :  $\frac{1}{4}$  W

$\frac{1}{4}$  W in resistance,  $\frac{1}{10}$  W and  $\frac{1}{8}$  W in chip resistance.

: nonflammable resistor

: fusible resistor

: internal component

: panel designation and adjustment for repair

: earth ground

: earth-chassis

All variable and adjustable resistors have characteristic curve B, unless otherwise noted.

Readings are taken with a color-bar signal input.

Readings are taken with a 10M $\Omega$  digital multimeter.

Voltages are DC with respect to ground unless otherwise noted.

Voltage variations may be noted due to normal production tolerances.

All voltages are in V.

S : Measurement impossibility.

: B+line

: B-line (Actual measured value may be different).

: signal path (RF)

Circled numbers are waveform references.

The components identified by shading and are critical for safety. Replace only with part number specified.

The symbol indicates a fast operating fuse and is displayed on the component side of the board. Replace only with fuse of the same rating as marked.

Les composants identifiés par un trame et une marque sont critiques pour la sécurité. Ne les remplacer que par une pièce portant le numéro spécifié.

Le symbole indique une fusible à action rapide. Doit être remplacé par une fusible de même valeur, comme marqué.

The components identified by in this basic schematic diagram have been carefully factory-selected for each set in order to satisfy regulations regarding X-ray radiation. Should replacement be necessary, replace only with the value originally used.

When replacing components identified by , make the necessary adjustments as indicated. If the results do not meet the specified value, change the component identified by and repeat the adjustment until the specified value is achieved. (Refer to Section 3: Safety Related Adjustments on Page 16.)

When replacing the parts listed in the table below, it is important to perform the related adjustments.

Part Replaced ()	Adjustment ()
<b>D BOARD:</b> <b>D8022, IC8001, IC8004, IC8005,</b> <b>IC8104, R8014, R8015, R8016,</b> <b>R8017, R8019, R8021, R8046,</b> <b>R8052, R8072, R8078, R8079,</b> <b>R8082, R8091, R8095</b> <b>GK BOARD:</b> <b>IC601</b>	<b>HV HOLD DOWN</b> <b>RV8002</b>

### REFERENCE INFORMATION

#### RESISTOR

: RN METAL FILM  
 : RC SOLID  
 : RPRD NONFLAMMABLE CARBON  
 : FUSE NONFLAMMABLE FUSIBLE  
 : RW NONFLAMMABLE WIREWOUND  
 : RS NONFLAMMABLE METAL OXIDE  
 : RB NONFLAMMABLE CEMENT  
 : ADJUSTMENT RESISTOR

#### COIL

: LF-8L MICRO INDUCTOR

#### CAPACITOR

: TA TANTALUM  
 : PS STYROL  
 : PP POLYPROPYLENE  
 : PT MYLAR  
 : MPS METALIZED POLYESTER  
 : MPP METALIZED POLYPROPYLENE  
 : ALB BIPOLAR  
 : ALT HIGH TEMPERATURE  
 : ALR HIGH RIPPLE

5-3. BLOCK DIAGRAM (PAGE 1 OF 4)

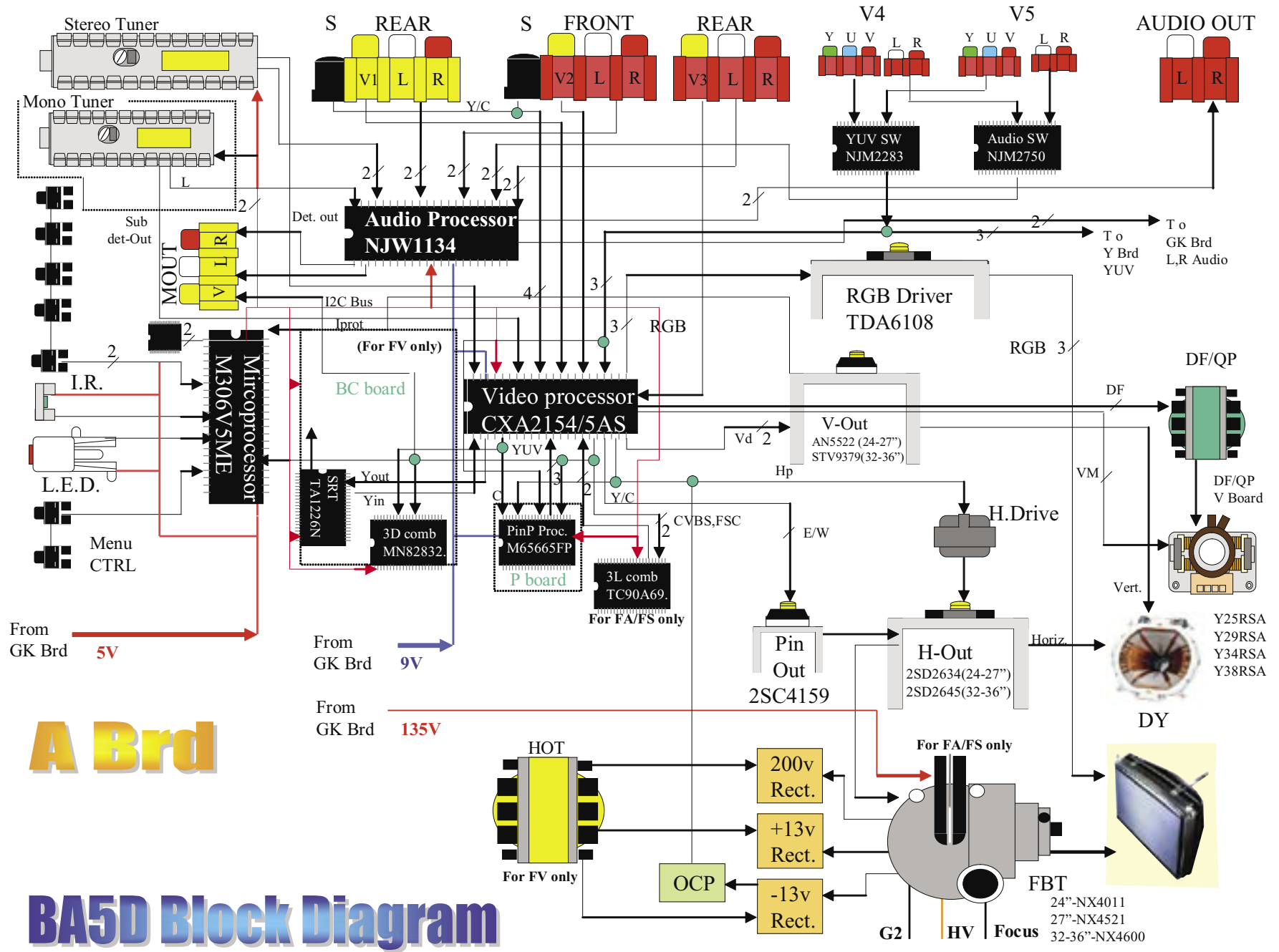

**A Brd**

**BA5D Block Diagram**

BLOCK DIAGRAM (PAGE 2 OF 4)

# BC, Circuit

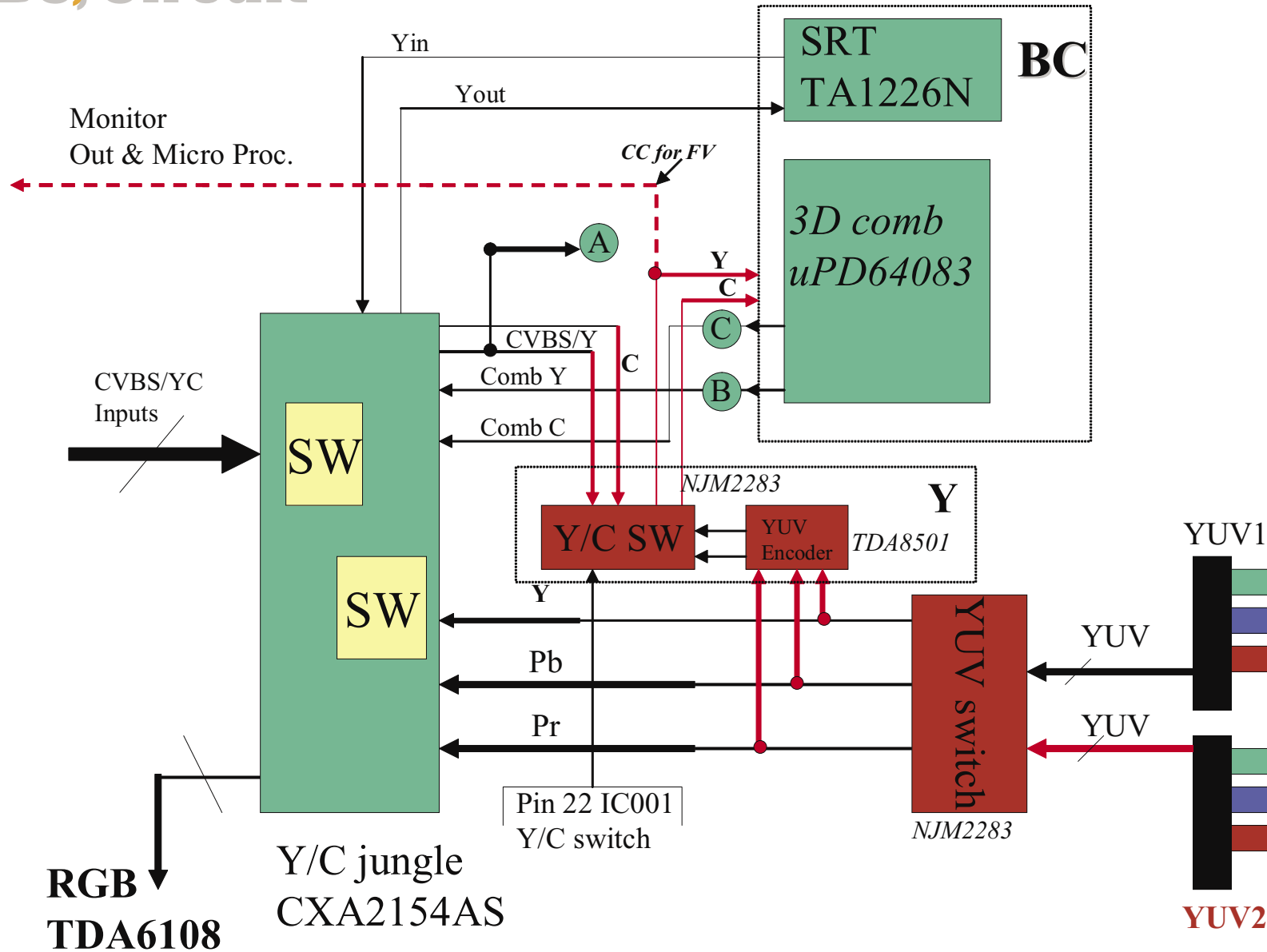

BLOCK DIAGRAM (PAGE 3 OF 4)

# GK Board

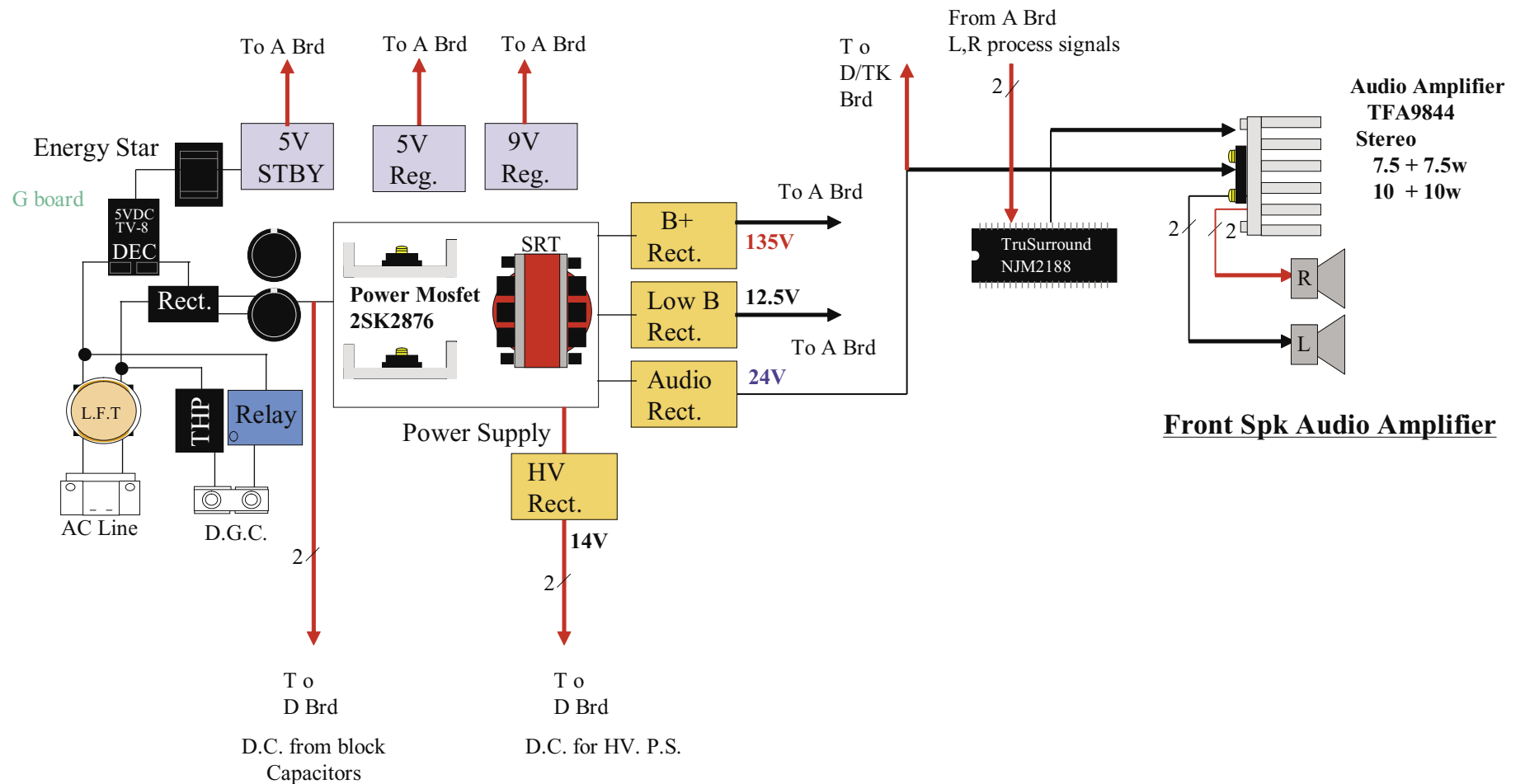

## Main Power Supply

BLOCK DIAGRAM (PAGE 4 OF 4)

# D Board

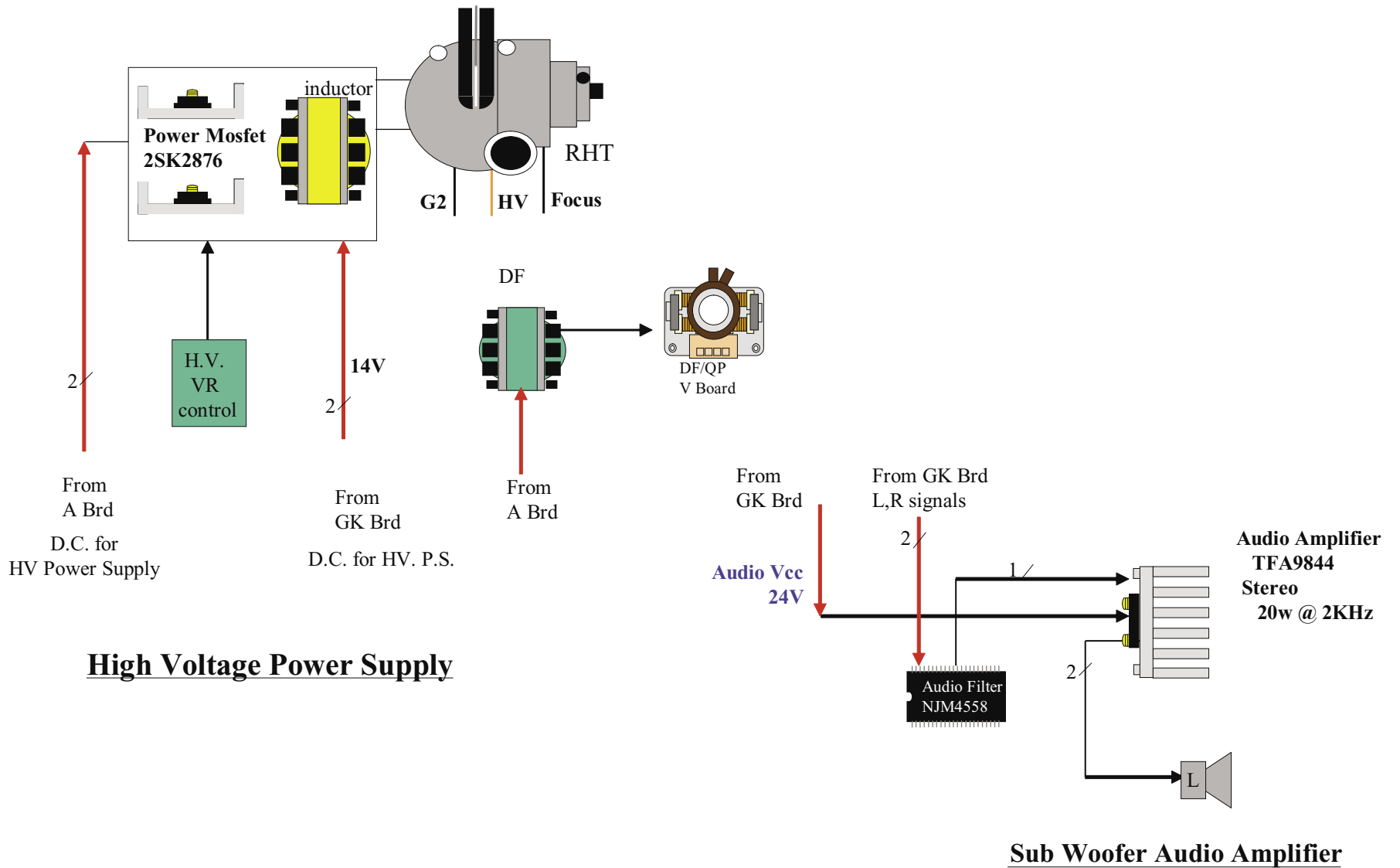

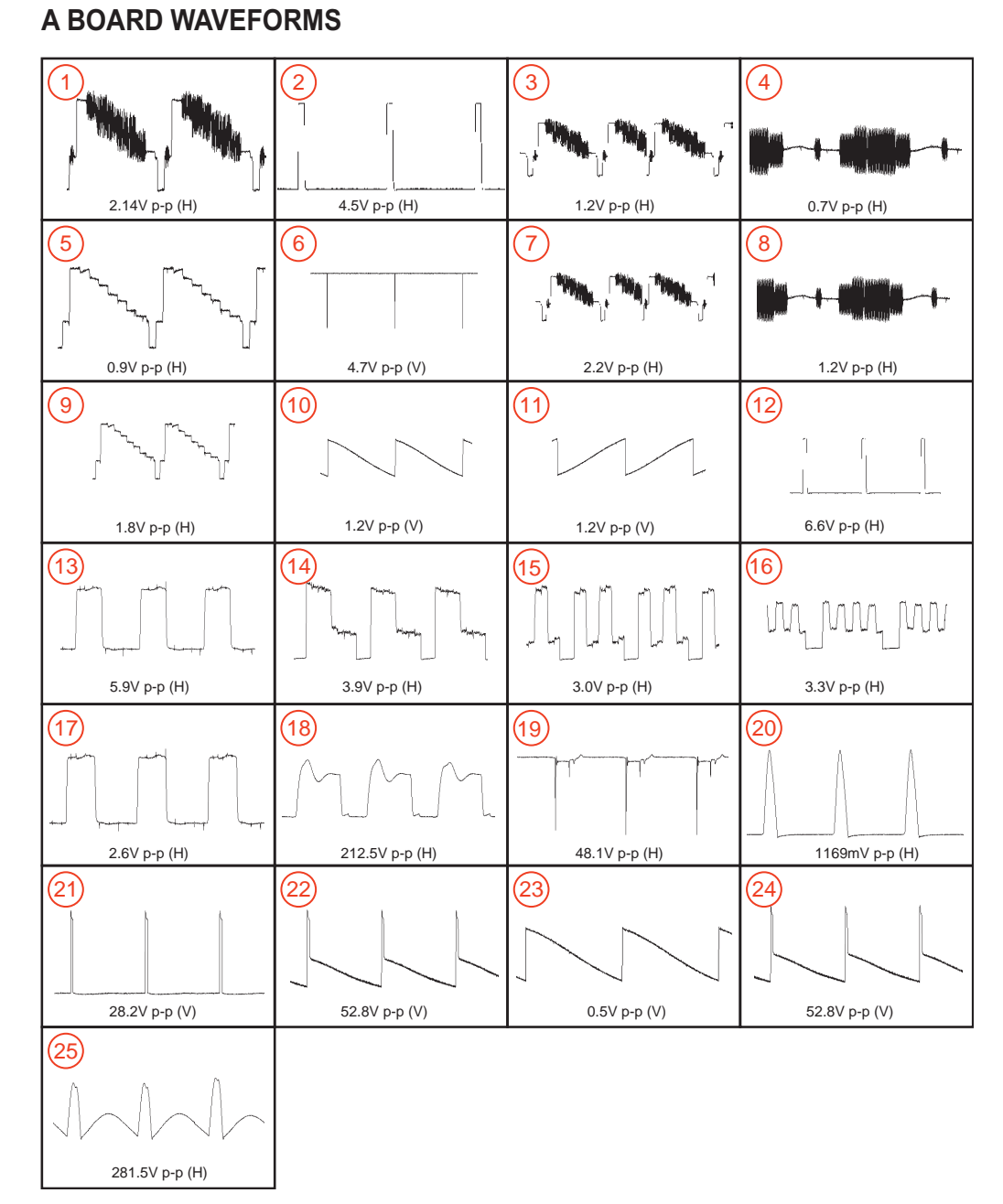
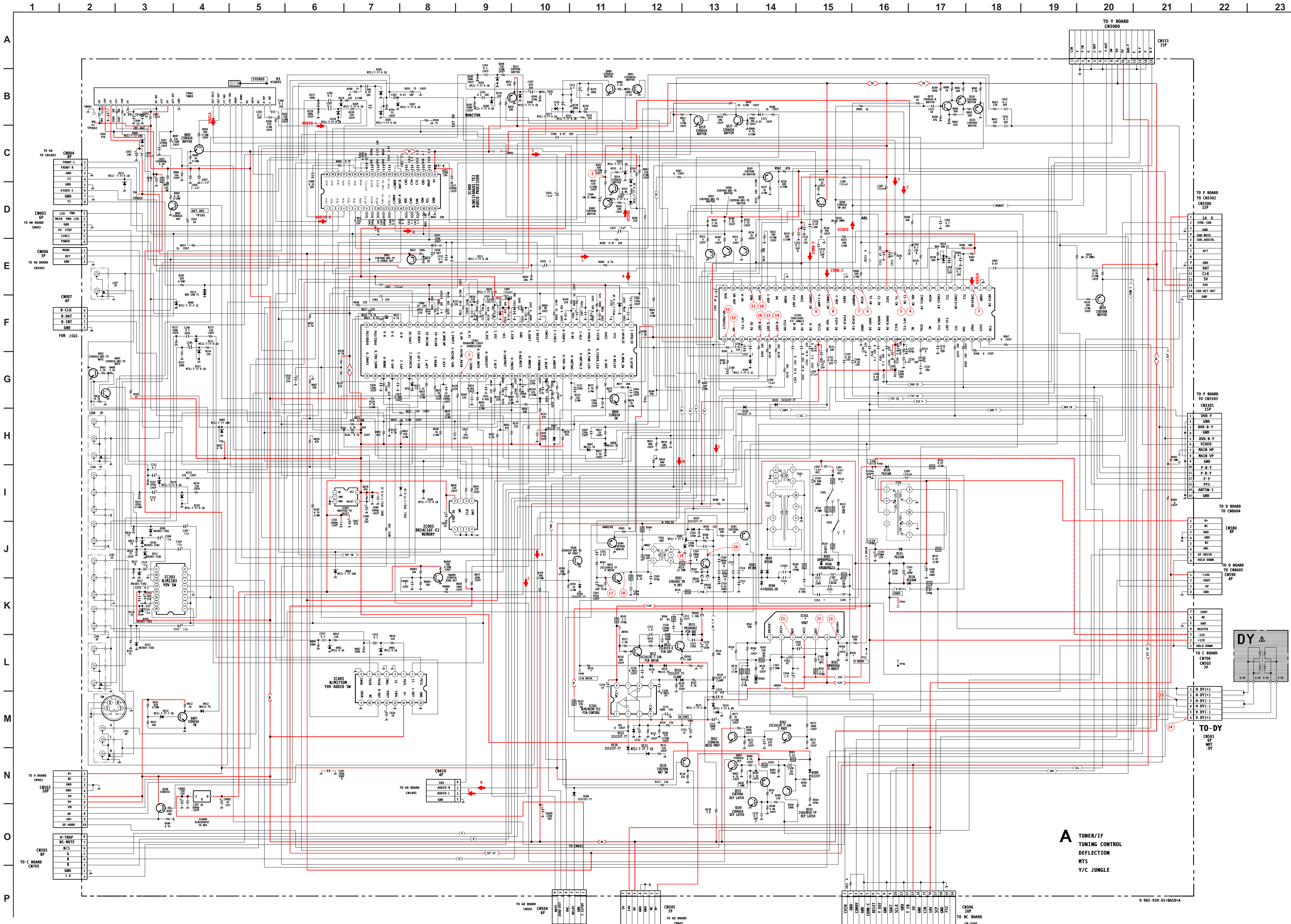

**A** TUNER/IF  
TUNING CONTROL  
DEFLECTION  
MTS  
Y/C JUNGLE



## A BOARD IC VOLTAGE LIST

IC001		41	5.0	IC301		41	4.6	IC400		5	2.3
PIN	VOLT	42	5.0	PIN	VOLT	42	4.6	PIN	VOLT	6	2.5
1	4.9	43	0.2	1	5.0	43	4.6	1	4.5	7	-13.5
2	0.6	44	0.6	2	GND	44	9.0	2	4.5	8	12.0
3	GND	45	1.2	3	5.0	45	0.1	3	4.5	IC561	
4	5.0	46	4.8	4	5.0	46	4.3	4	4.5	PIN	VOLT
5	0.2	47	4.8	5	4.8	47	5.2	5	4.5	1	1.5
6	1.7	48	0.0	6	5.0	48	5.2	6	4.5	2	12.0
7	1.4	49	0.1	7	4.8	49	GND	7	4.5	3	-12.0
8	0.5	50	4.4	8	3.4	50	4.8	8	4.5	4	-15.0
9	0.0	51	5.0	9	5.2	51	5.2	9	4.5	5	0.3
10	5.0	52	0.1	10	1.9	52	5.2	10	4.5	6	14.2
11	GND	53	0.0	11	0.0	53	9.1	11	4.5	7	1.4
12	5.0	54	4.8	12	4.8	54	5.3	12	4.5	IC6008	
13	2.3	55	0.1	13	9.0	55	N/C	13	4.5	PIN	VOLT
14	GND	56	0.0	14	0.0	56	1.7	14	4.5	I	7.5
15	2.1	57	4.8	15	4.8	57	N/C	15	0.6	O	5.0
16	5.0	58	N/C	16	4.9	58	6.9	16	1.7	G	GND
17	2.6	59	N/C	17	4.4	59	N/C	IC405		All voltages are in V.	
18	2.6	60	0.0	18	0.0	60	4.7	PIN	VOLT		
19	0.3	61	0.1	19	3.8	61	4.7	1	4.5		
20	0.0	62	4.6	20	5.5	62	4.7	2	0.0		
21	2.1	63	0.1	21	3.6	63	1.1	3	4.5		
22	5.0	64	N/C	22	5.8	64	5.1	4	GND		
23	5.0	IC002		23	9.0	IC303		5	GND		
24	5.0	PIN	VOLT	24	4.4	PIN	VOLT	6	4.5		
25	5.0	1	N/C	25	0.0	1	4.5	7	4.5		
26	5.0	2	GND	26	4.1	2	4.0	8	GND		
27	5.0	3	GND	27	2.4	3	3.0	9	GND		
28	0.0	4	5.0	28	3.5	4	GND	10	N/C		
29	0.0	5	5.0	29	3.5	5	4.0	11	4.5		
30	0.0	IC003		30	5.9	6	4.0	12	4.5		
31	N/C	PIN	VOLT	31	5.5	7	0.0	13	GND		
32	N/C	1	GND	32	7.6	8	4.5	14	9.0		
33	4.8	2	GND	33	3.6	9	4.5	15	4.5		
34	0.0	3	GND	34	2.8	10	GND	16	GND		
35	0.0	4	GND	35	2.5	11	4.5	IC501			
36	0.0	5	5.0	36	3.9	12	0.0	PIN	VOLT		
37	0.0	6	5.0	37	1.5	13	9V	1	-13.3		
38	4.2	7	0.0	38	1.6	14	4.5	2	8.2		
39	1.7	8	5.0	39	1.5	15	GND	3	7.2		
40	2.6			40	0.0	16	4.5	4	-15.0		

### A BOARD TRANSISTOR VOLTAGE LIST

	B	C	E		B	C	E
Q001	0.0	0.4	5.0	Q400	0.0	0.0	GND
Q002	4.4	9.0	3.8	Q401	0.0	0.0	GND
Q003	0.7	0.0	GND	Q402	0.0	0.0	GND
Q004	0.0	4.3	GND	Q403	0.0	0.0	GND
Q005	0.1	4.9	GND	Q407	0.7	0.0	GND
Q010	4.3	GND	4.9	Q500	3.5	9.0	2.9
Q110	4.8	0.0	5.0	Q501	0.0	123.6	GND
Q300	4.6	GND	5.2	Q502	0.0	131.8	0.0
Q304	5.0	9.0	4.4	Q511	-13.5	-8.4	-15.0
Q305	5.0	0.0	3.4	Q512	-14.9	-2.0	-15.0
Q307	1.5	GND	2.2	Q530	0.0	4.4	GND
Q308	1.5	GND	2.2	Q531	4.4	0.0	4.4
Q309	1.5	GND	2.2	Q532	133.6	0.0	133.8
Q314	0.0	3.4	GND	Q561	0.0	4.4	GND
Q315	3.4	GND	4.1	Q562	0.0	0.0	GND
Q316	6.4	2.7	7.1	Q580	5.0	GND	0
Q317	0.0	3.9	GND	Q581	0.0	GND	0
Q319	0.6	0.6	GND	Q590	0.0	3.6	GND
Q325	2.6	6.4	1.9	Q6000	0.6	1.2	GND
Q326	2.7	GND	3.4				

All voltages are in V.

### IC001 BLOCK DIAGRAM

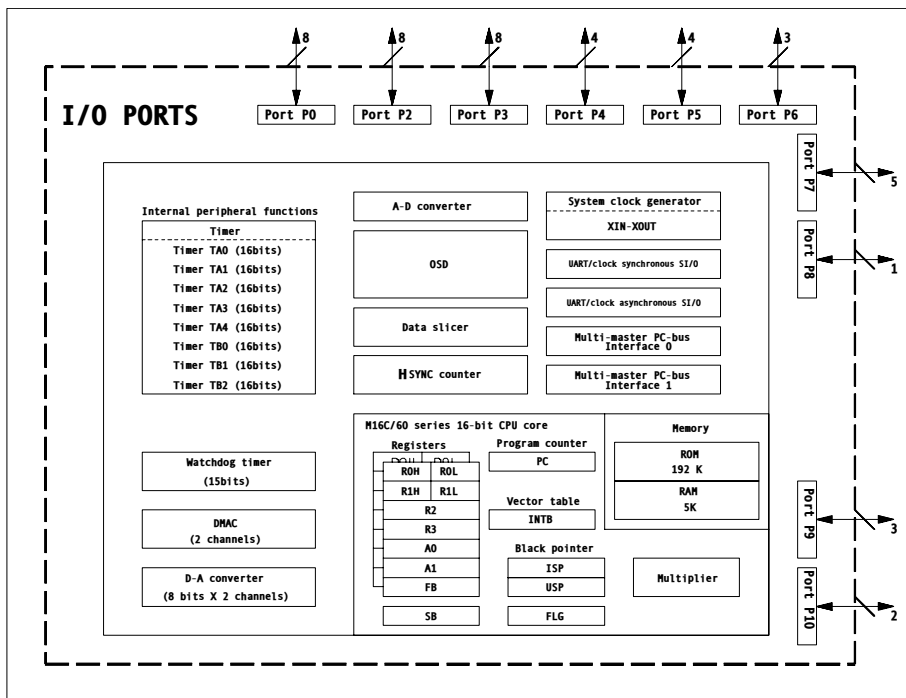



**A** COMPONENT SIDE [TUNING CONTROL, DEFLECTION, TUNER/IF, Y/C JUNGLE, MTS]

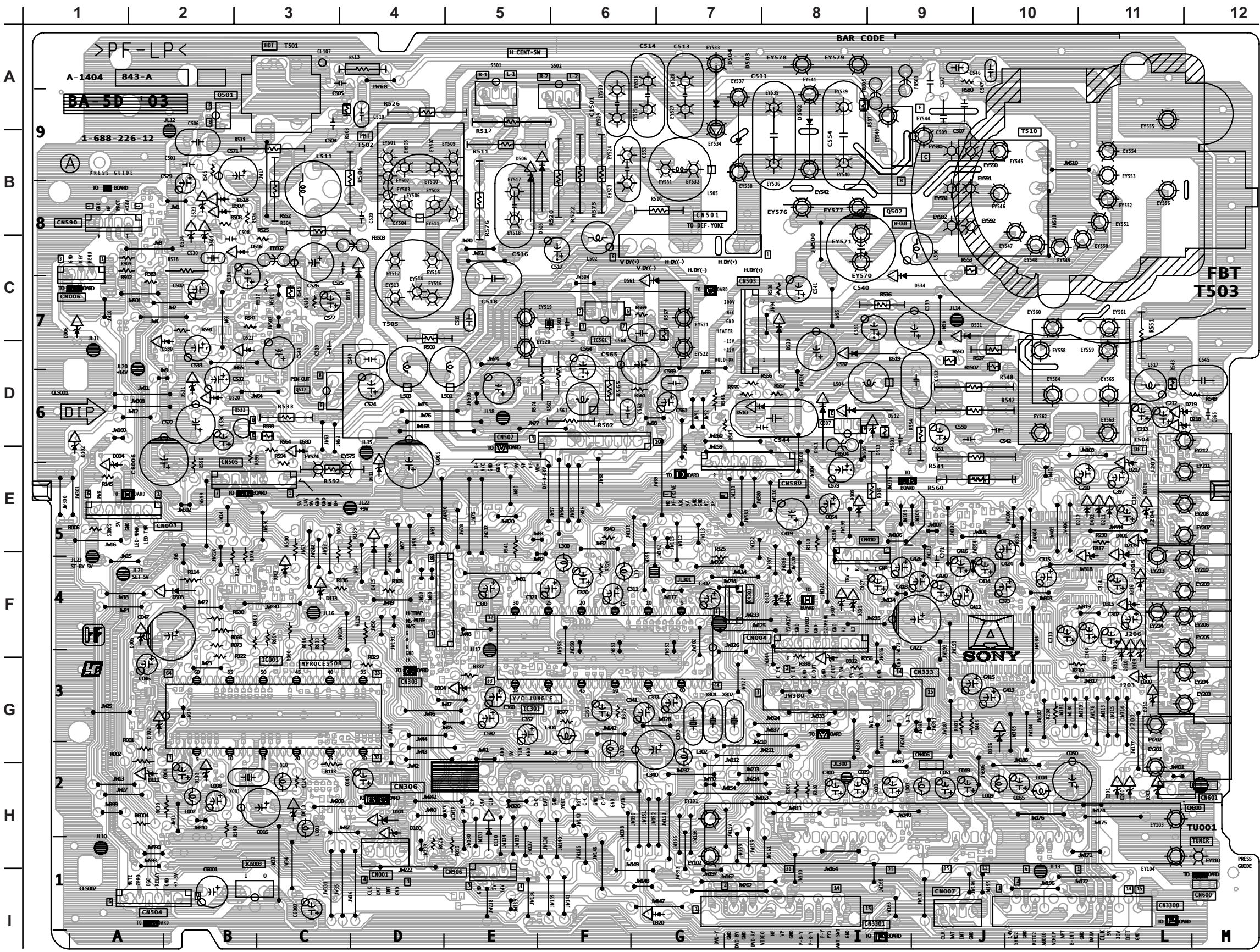





HR BOARD SCHEMATIC DIAGRAM

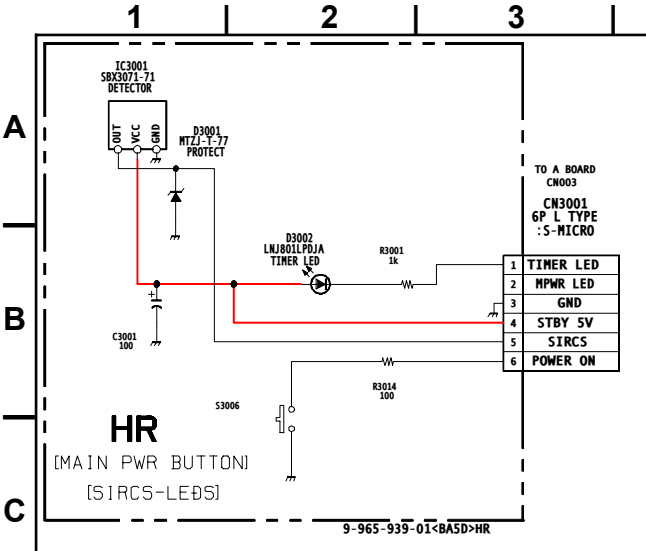

**HR** COMPONENT SIDE [MAIN POWER BUTTON]

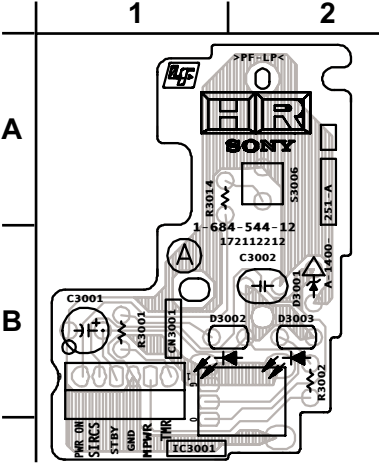

**HR** COMPONENT SIDE [MAIN POWER BUTTON]

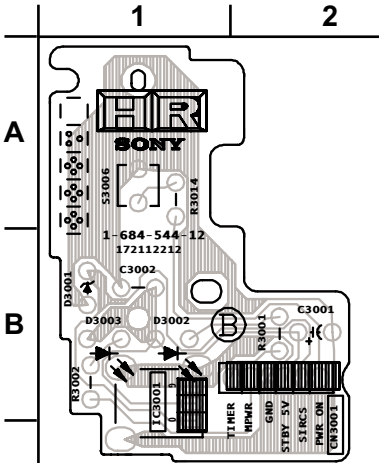



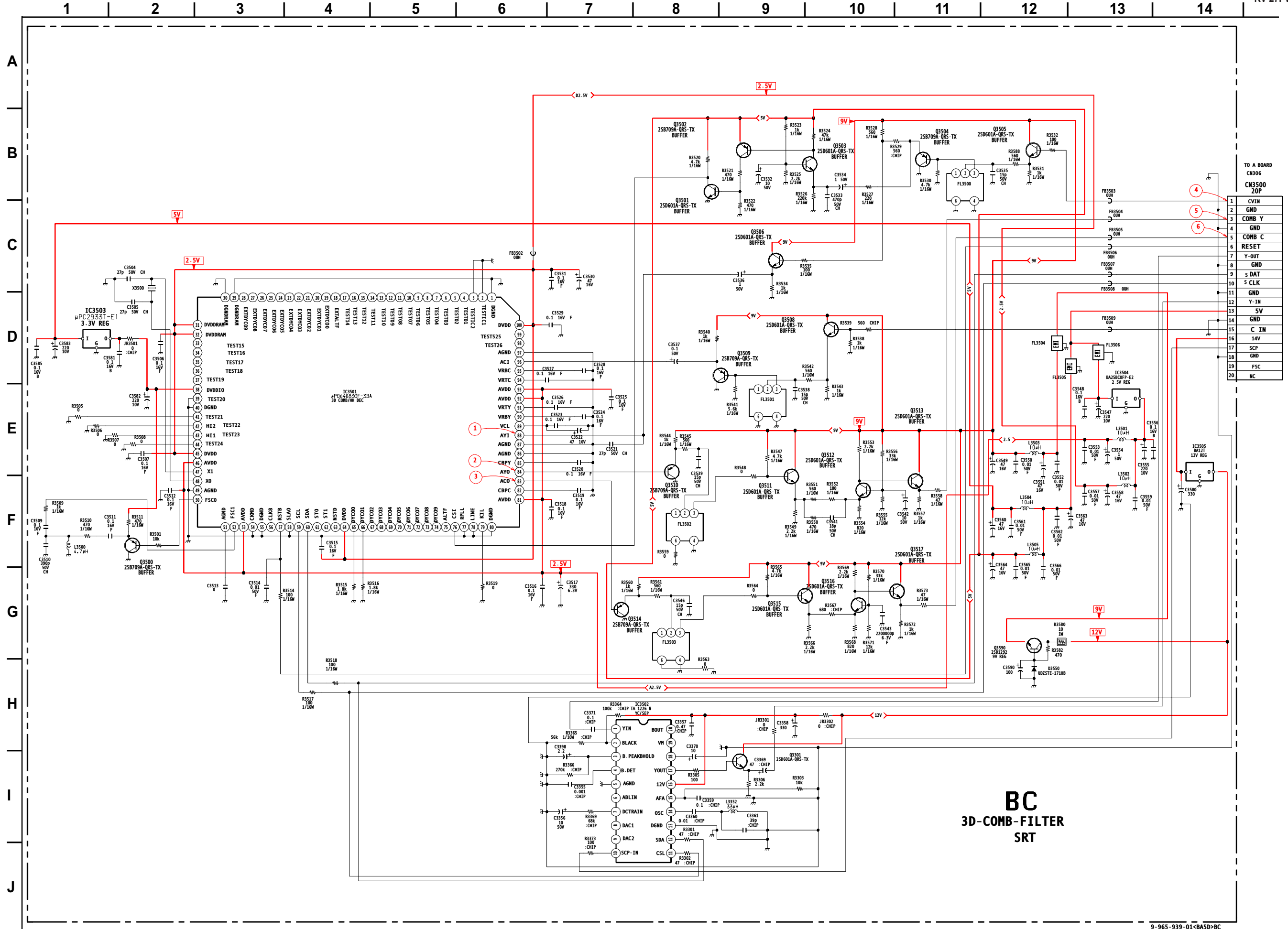

TO A BOARD  
CN306  
CN3500  
Z0P

1	CVIN
2	GND
3	COMB Y
4	GND
5	COMB C
6	RESET
7	Y-OUT
8	GND
9	S DAT
10	S CLK
11	GND
12	Y-IN
13	5V
14	GND
15	C IN
16	14V
17	SCP
18	GND
19	FSC
20	NC

**BC**  
3D-COMB-FILTER  
SRT

**BC BOARD IC VOLTAGE LIST**

IC3501		27	N/C	55	GND	83	1.4	9	N/C
PIN	VOLT	28	N/C	56	N/C	84	1.4	10	1.2
1	GND	29	GND	57	4.8	85	1.1	11	4.7
2	GND	30	GND	58	GND	86	GND	12	4.7
3	GND	31	2.5	59	4.7	87	0.0	13	0.0
4	N/C	32	2.5	60	4.7	88	1.1	14	11.5
5	N/C	33	N/C	61	N/C	89	0.7	15	4.8
6	N/C	34	N/C	62	N/C	90	0.7	16	12.0
7	N/C	35	N/C	63	N/C	91	1.3	17	0.0
8	N/C	36	N/C	64	2.5	92	2.5	18	0.5
9	N/C	37	N/C	65	0.0	93	2.5	19	N/C
10	N/C	38	3.3	66	0.0	94	0.0	20	N/C
11	N/C	39	GND	67	N/C	95	0.0	<b>IC3503</b>	
12	N/C	40	GND	68	N/C	96	1.1	<b>PIN</b>	<b>VOLT</b>
13	N/C	41	GND	69	N/C	97	GND	I	5.0
14	N/C	42	GND	70	N/C	98	N/C	O	3.3
15	N/C	43	GND	71	N/C	99	N/C	G	GND
16	N/C	44	GND	72	N/C	100	2.5	<b>IC3504</b>	
17	N/C	45	2.5	73	N/C	<b>IC3502</b>		<b>PIN</b>	<b>VOLT</b>
18	N/C	46	2.5	74	N/C	<b>PIN</b>	<b>VOLT</b>	I	5.0
19	N/C	47	1.3	75	N/C	1	4.7	O	2.5
20	N/C	48	1.0	76	4.2	2	3.8	G	GND
21	N/C	49	GND	77	GND	3	3.9	<b>IC3505</b>	
22	N/C	50	1.4	78	GND	4	4.7	<b>PIN</b>	<b>VOLT</b>
23	N/C	51	GND	79	GND	5	GND	I	14.0
24	N/C	52	1.3	80	GND	6	N/C	O	12.0
25	N/C	53	2.5	81	2.5	7	4.8	G	GND
26	N/C	54	GND	82	1.1	8	N/C	All voltages are in V.	

**BC BOARD TRANSISTOR VOLTAGE LIST**

	B	C	E		B	C	E
<b>Q3500</b>	1.4	GND	2.1	<b>Q3510</b>	2.1	GND	1.4
<b>Q3501</b>	4.7	4.2	GND	<b>Q3511</b>	2.3	9.0	2.9
<b>Q3502</b>	4.7	0.5	5.0	<b>Q3512</b>	2.5	5.7	1.9
<b>Q3503</b>	3.3	4.7	3.5	<b>Q3513</b>	5.7	9.0	5.0
<b>Q3504</b>	3.3	GND	4.0	<b>Q3514</b>	1.4	GND	2.1
<b>Q3505</b>	4.3	9.0	3.7	<b>Q3515</b>	2.9	9.0	2.3
<b>Q3506</b>	6.2	9.0	5.6	<b>Q3516</b>	2.5	6.0	1.9
<b>Q3508</b>	2.4	9.0	1.8	<b>Q3517</b>	6.0	9.0	5.4
<b>Q3509</b>	1.7	GND	2.3	<b>Q3590</b>	10.2	11.3	9.0

All voltages are in V.

**BC BOARD WAVEFORM**

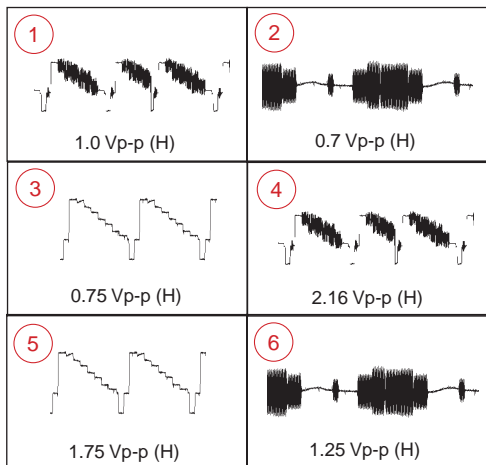

**BC** COMPONENT SIDE [3D - COMB - FILTER SRT]

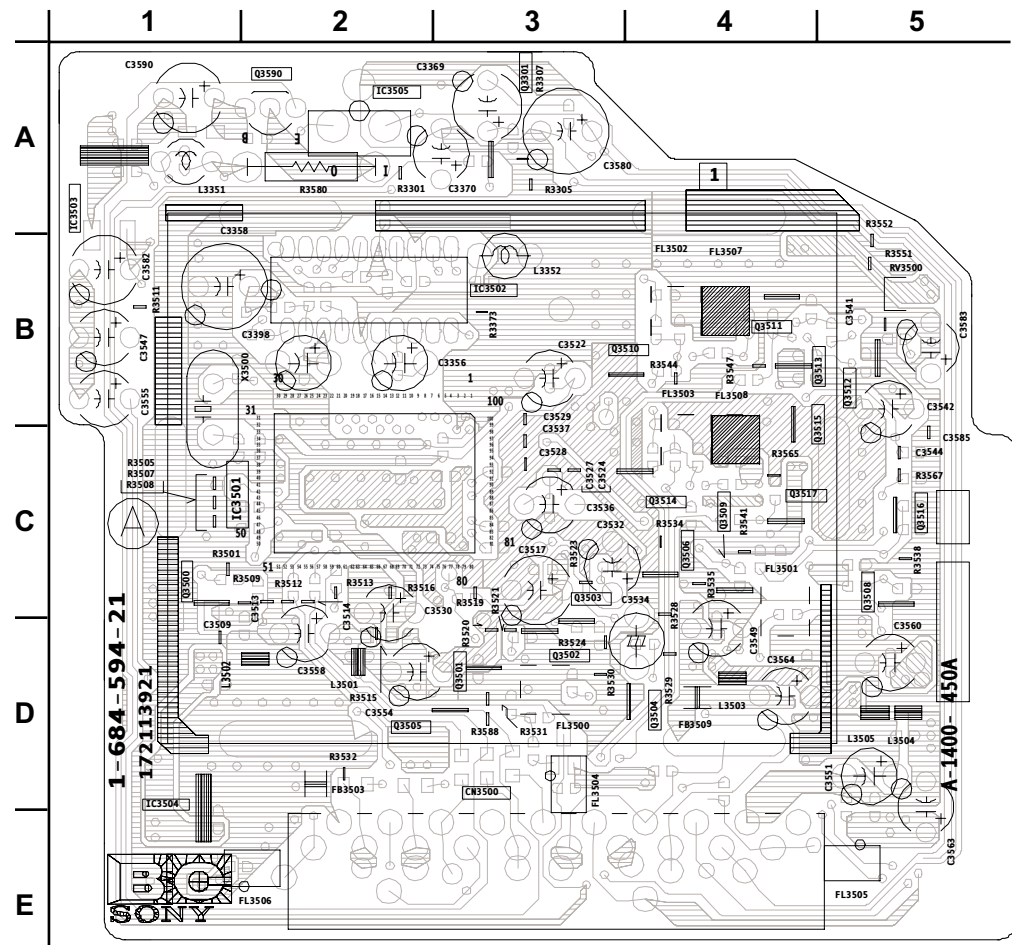

**BC** CONDUCTOR SIDE [3D - COMB - FILTER SRT]

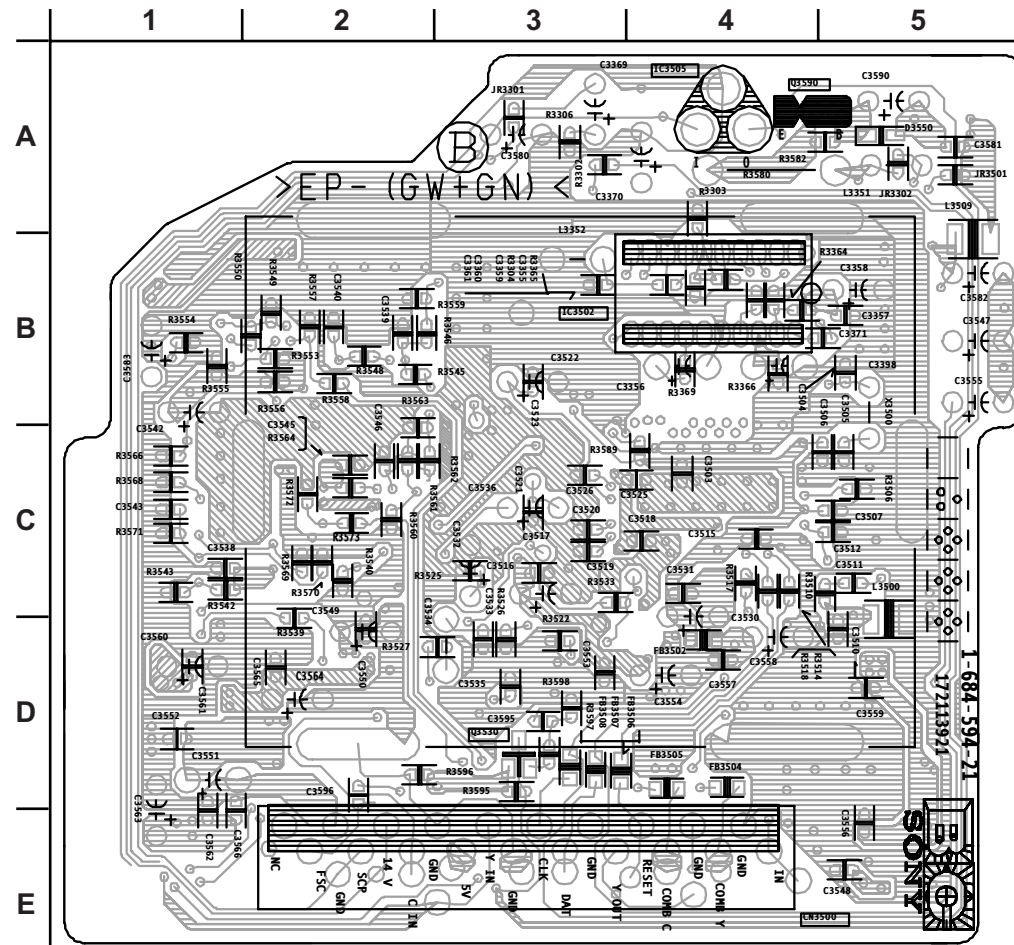

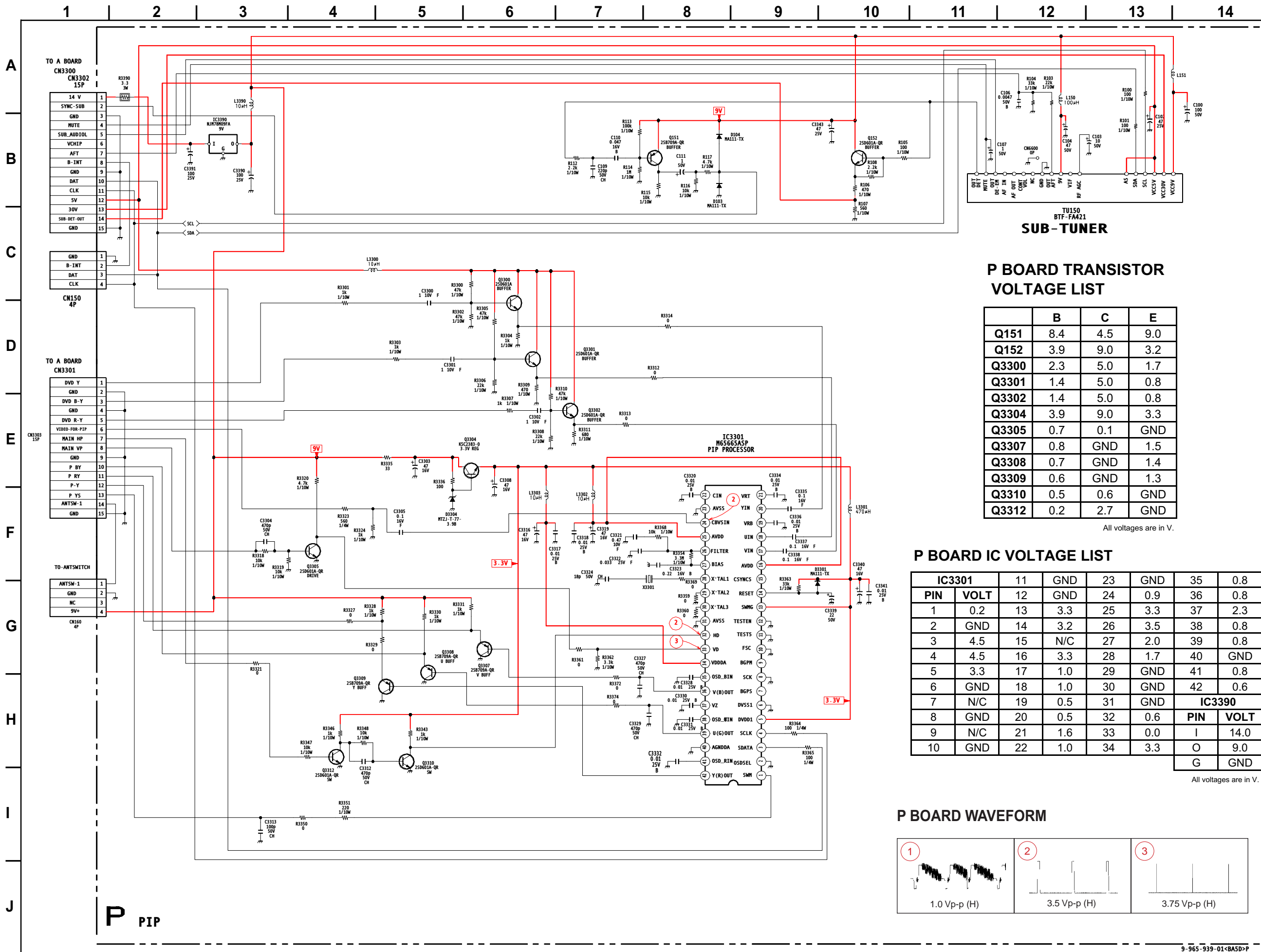

**SUB-TUNER**

**P BOARD TRANSISTOR VOLTAGE LIST**

	B	C	E
Q151	8.4	4.5	9.0
Q152	3.9	9.0	3.2
Q3300	2.3	5.0	1.7
Q3301	1.4	5.0	0.8
Q3302	1.4	5.0	0.8
Q3304	3.9	9.0	3.3
Q3305	0.7	0.1	GND
Q3307	0.8	GND	1.5
Q3308	0.7	GND	1.4
Q3309	0.6	GND	1.3
Q3310	0.5	0.6	GND
Q3312	0.2	2.7	GND

All voltages are in V.

**P BOARD IC VOLTAGE LIST**

IC3301		11	GND	23	GND	35	0.8
PIN	VOLT	12	GND	24	0.9	36	0.8
1	0.2	13	3.3	25	3.3	37	2.3
2	GND	14	3.2	26	3.5	38	0.8
3	4.5	15	N/C	27	2.0	39	0.8
4	4.5	16	3.3	28	1.7	40	GND
5	3.3	17	1.0	29	GND	41	0.8
6	GND	18	1.0	30	GND	42	0.6
7	N/C	19	0.5	31	GND	<b>IC3390</b>	
8	GND	20	0.5	32	0.6		
9	N/C	21	1.6	33	0.0	I	14.0
10	GND	22	1.0	34	3.3	O	9.0
						G	GND

All voltages are in V.

**P BOARD WAVEFORM**

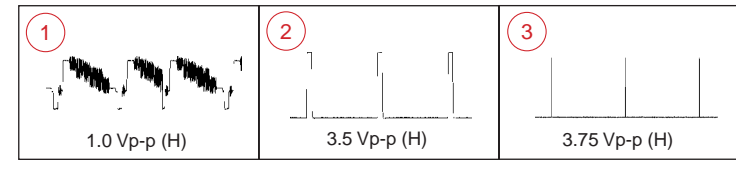

**P** PIP







**Y BOARD SCHEMATIC DIAGRAM**

Due to the complexity of this board, performing component level field repairs is not recommended. If service is required, complete board replacement is the preferred repair method. Data is provided for reference only.

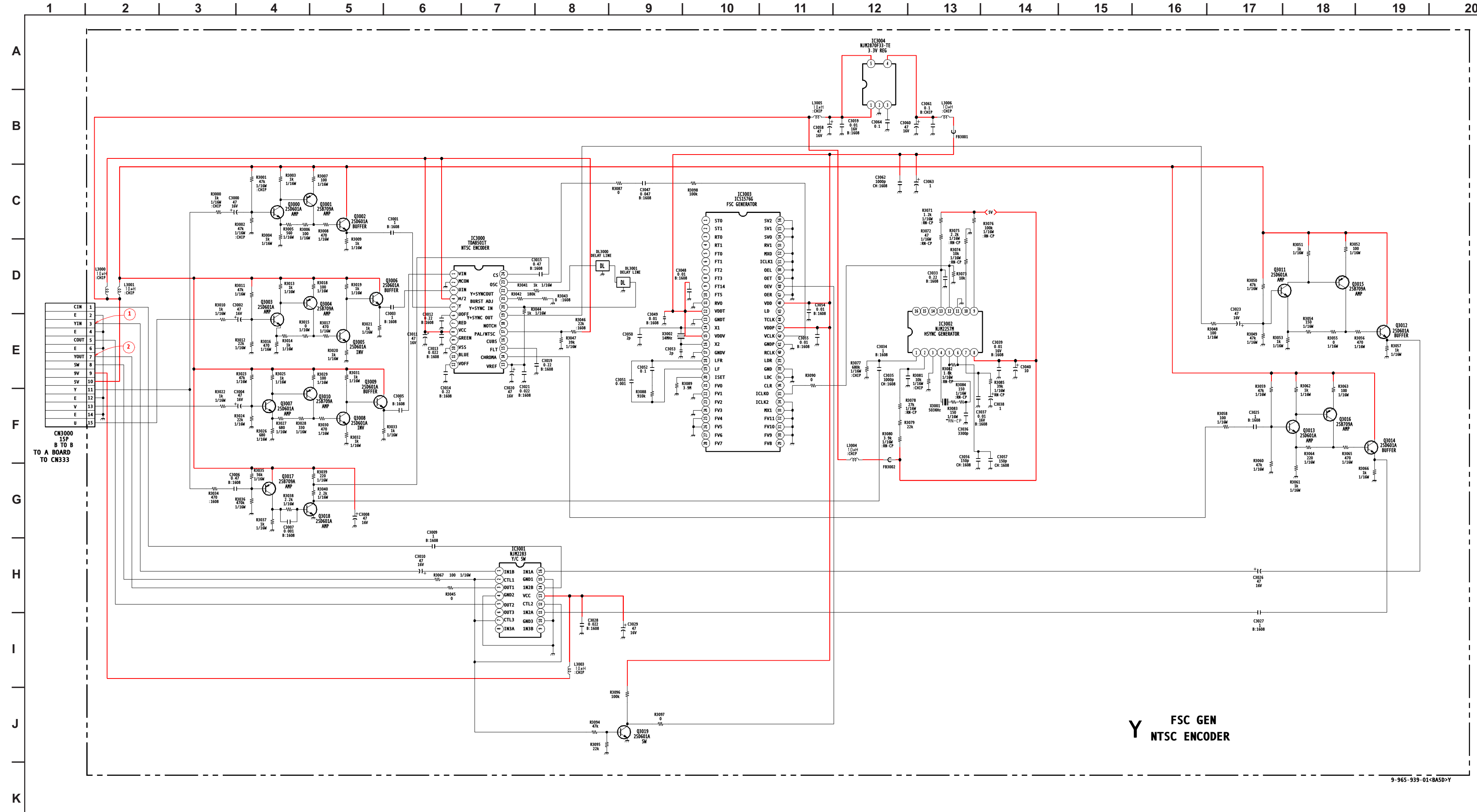

**Y BOARD WAVEFORMS**

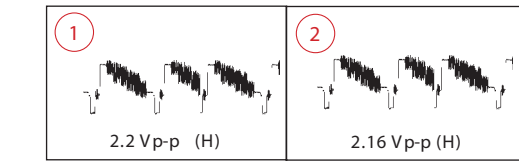

**Y COMPONENT SIDE [FSC GEN NTSC ENCODER]**

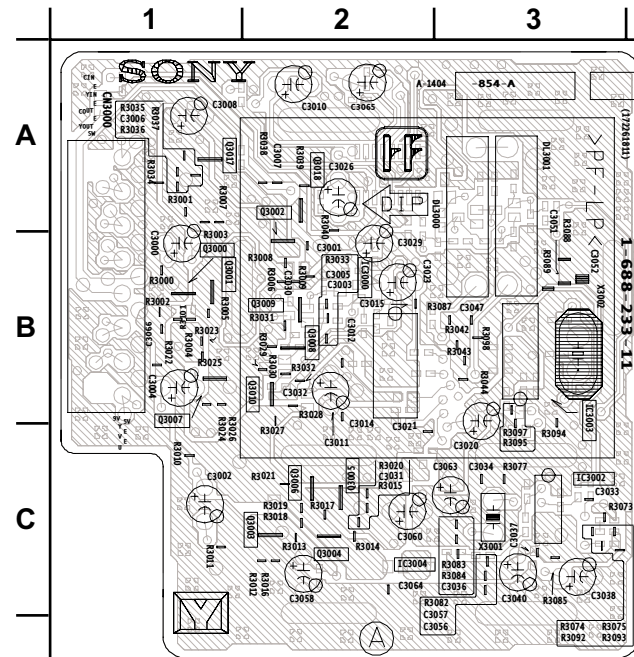

**Y CONDUCTOR SIDE [FSC GEN NTSC ENCODER]**

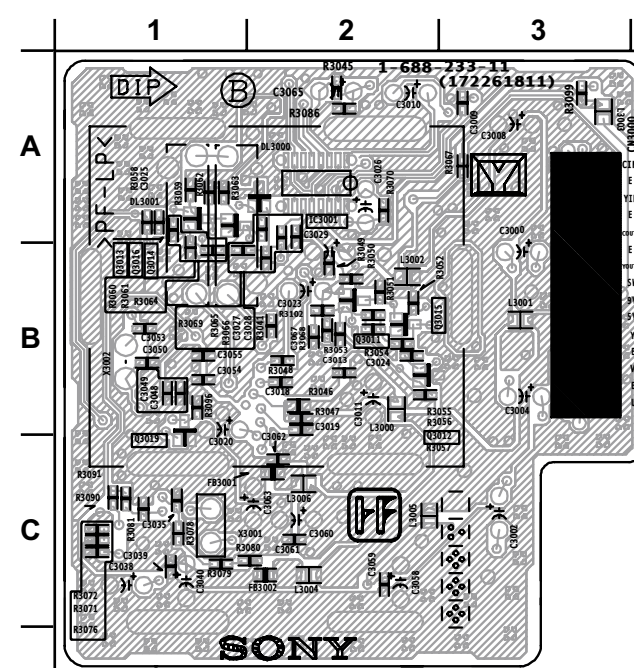

# HU BOARD SCHEMATIC DIAGRAM

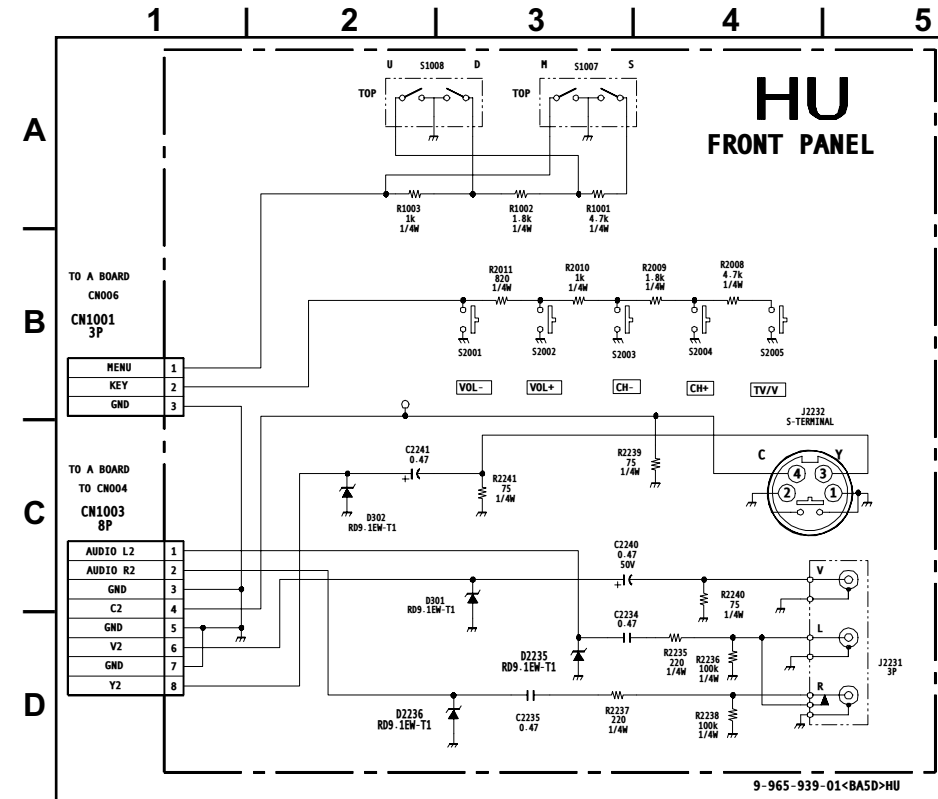

# HU CONDUCTOR SIDE [FRONT PANEL]

KV-27FV310/29FV310/32FV310/36FV310

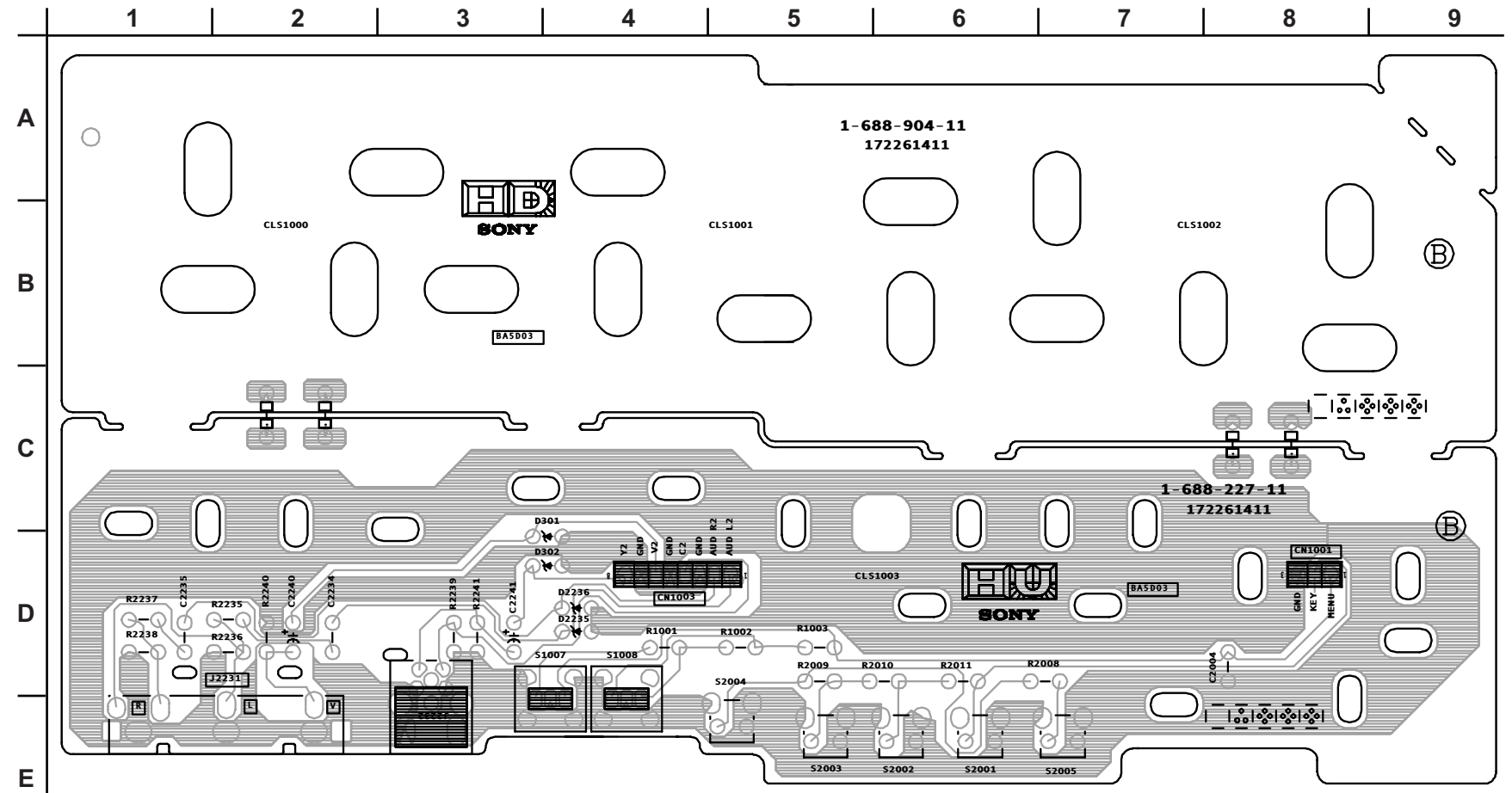

# HU COMPONENT SIDE [FRONT PANEL]

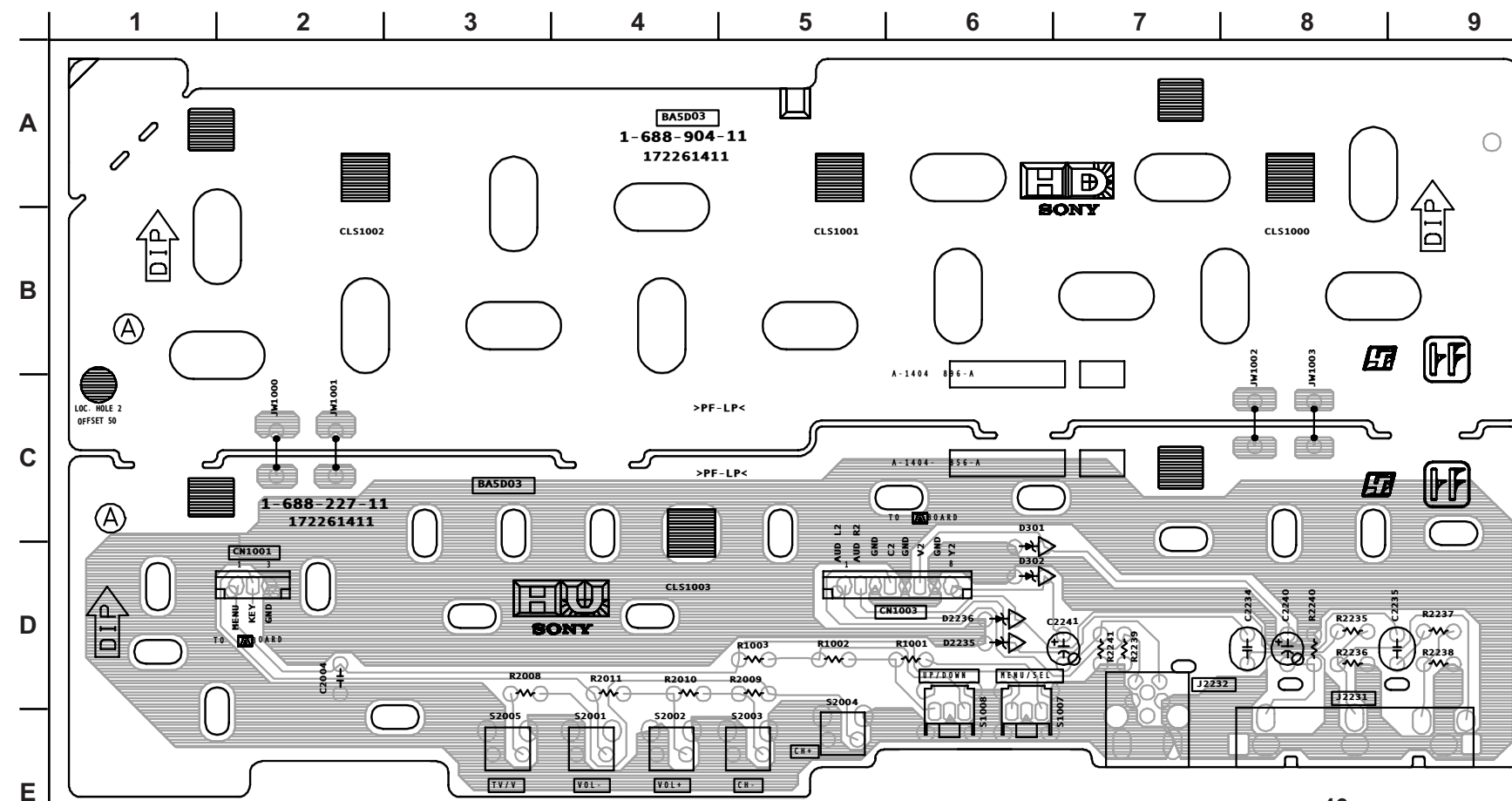

D BOARD SCHEMATIC DIAGRAM

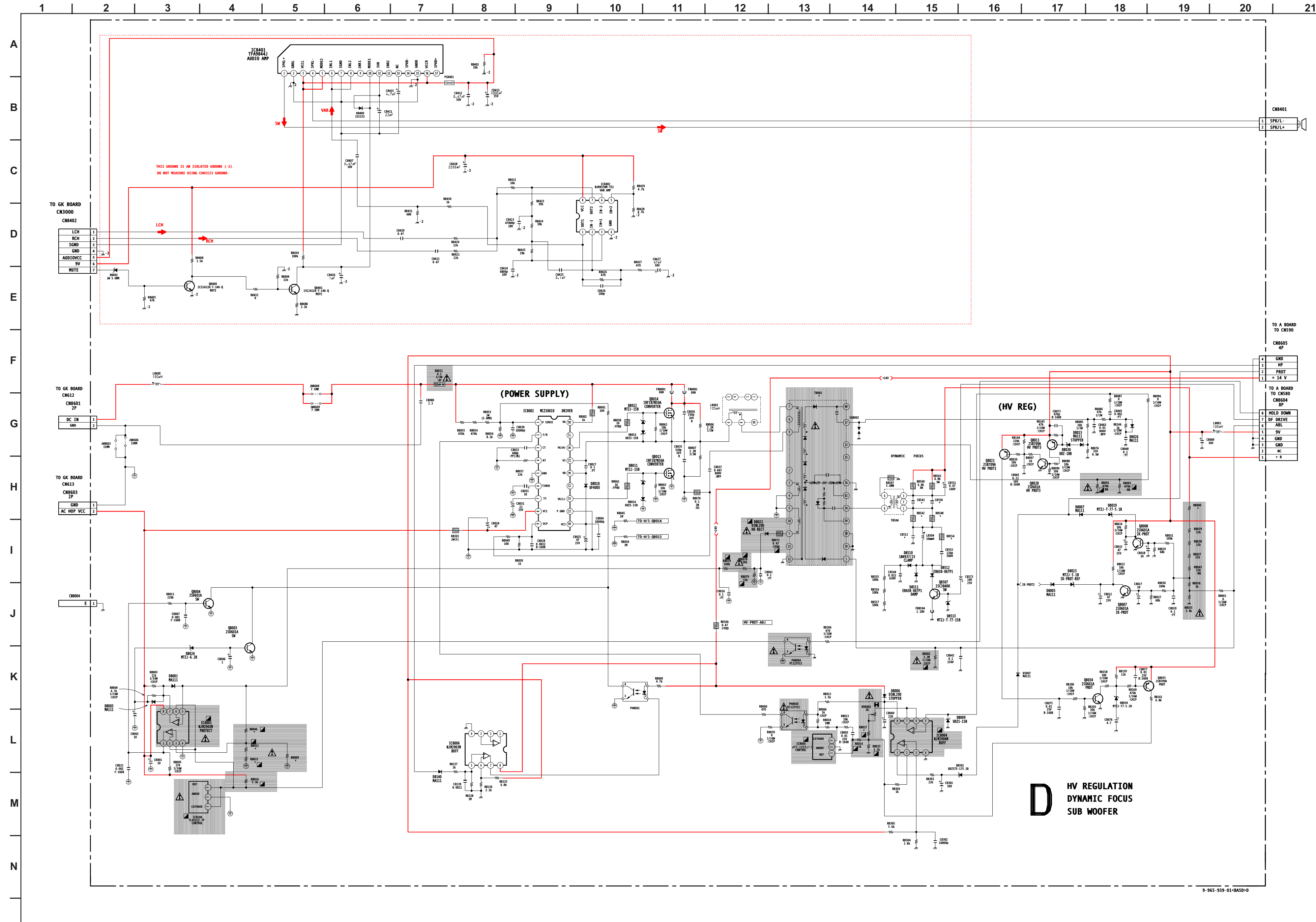

D BOARD IC VOLTAGE LIST

IC8001		IC8004		IC8401	
PIN	VOLT	PIN	VOLT	PIN	VOLT
1	0.0	1	14.0	1	8.3
2	2.5	2	0.9	2	GND
3	2.1	3	0.9	3	19.6
4	GND	4	GND	4	8.3
5	2.3	5	7.1	5	19.6
6	2.5	6	7.1	6	3.2
7	0.0	7	7.1	7	0.0
8	17.5	8	45.2	8	0.0
IC8002		IC8005		IC8006	
PIN	VOLT	PIN	VOLT	PIN	VOLT
1	2.8	1	2.4	11	9.7
2	1.9	2	GND	12	3.2
3	2.3	3	11.0	13	3.3
4	2.6	IC8006		14	8.3
5	GND	PIN	VOLT	15	GND
6	0.0	1	N/C	16	19.6
7	4.6	2	N/C	17	8.3
8	17.5	3	N/C	IC8402	
9	0.0	4	GND	PIN	VOLT
10	10.6	5	2.3	1	4.6
11	0.0	6	2.5	2	4.6
12	4.9	7	0.0	3	4.6
13	2.3	8	14.0	4	GND
14	163.9	IC8104		5	4.6
15	153.8	PIN	VOLT	6	4.6
16	158.2	1	2.5	7	4.6
17	2.6	2	GND	8	9.0
18	314.0	3	2.5	All voltages are in V.	

D BOARD TRANSISTOR VOLTAGE LIST

	B	C	E
Q8003	0.2	2.7	GND
Q8004	0.2	2.7	GND
Q8007	0.0	0.0	GND
Q8008	0.0	0.0	GND
Q8011	9.0	0.0	9.0
Q8021	9.0	0.0	9.0
Q8028	0.0	9.0	GND
Q8034	0.0	9.0	GND
Q8035	9.0	2.5	9.0
Q8400	0.0	0.0	GND
Q8401	0.0	0.0	GND
Q8507	0.0	38.0	GND

  

	D	G	S
Q8013	155.0	4.3	GND
Q8014	315.0	158.0	156.0

All voltages are in V.



**D COMPONENT SIDE [HV REGULATION, DYNAMIC FOCUS, SUB WOOFER]**

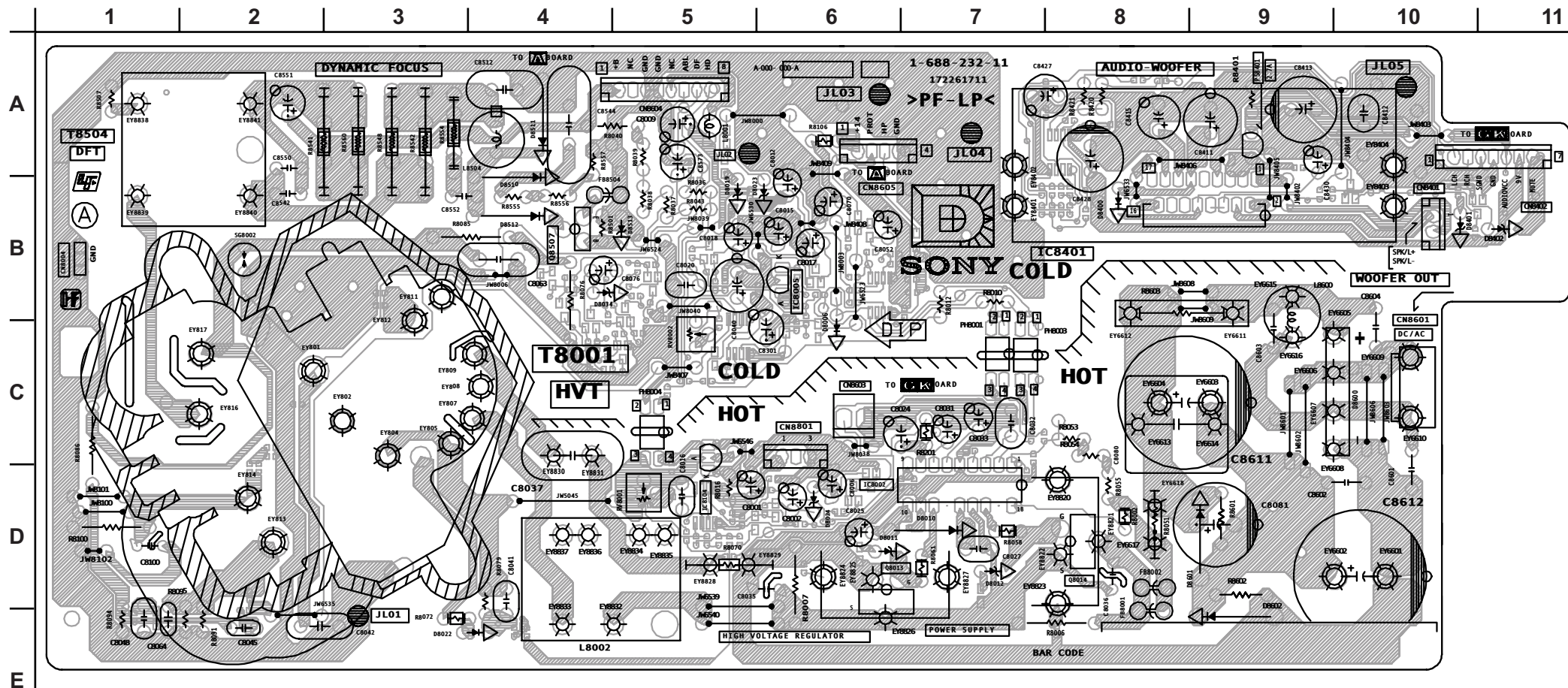

**D BOARD LOCATOR LIST**

DIODE		IC	
D5007	B-5	IC8001	D-6
D8001	D-6	IC8002	D-5
D8003	D-6	IC8004	B-6
D8005	A-6	IC8005	B-6
D8006	B-5	IC8006	C-5
D8007	A-7	IC8104	C-6
D8009	C-7	IC8401	B-3
D8010	D-5	IC8402	A-4
D8011	D-5		
D8012	D-4		
D8013	D-4		
D8014	D-5		
D8015	B-8		
D8019	B-6		
D8022	D-8		
D8023	B-6		
D8024	D-6		
D8026	D-10		
D8030	B-8		
D8034	B-7		
D8140	B-5		
D8301	B-5		
D8400	B-4		
D8510	B-8		
D8511	A-8		
D8512	B-8		
D8513	B-7		

  

TRANSISTOR	
Q8003	D-5
Q8004	D-5
Q8007	B-6
Q8008	B-6
Q8011	C-8
Q8013	E-5
Q8014	D-4
Q8021	C-8
Q8028	C-7
Q8034	C-8
Q8035	B-7
Q8400	B-1
Q8401	B-2
Q8507	B-8

**D CONDUCTOR SIDE [HV REGULATION, DYNAMIC FOCUS, SUB WOOFER]**

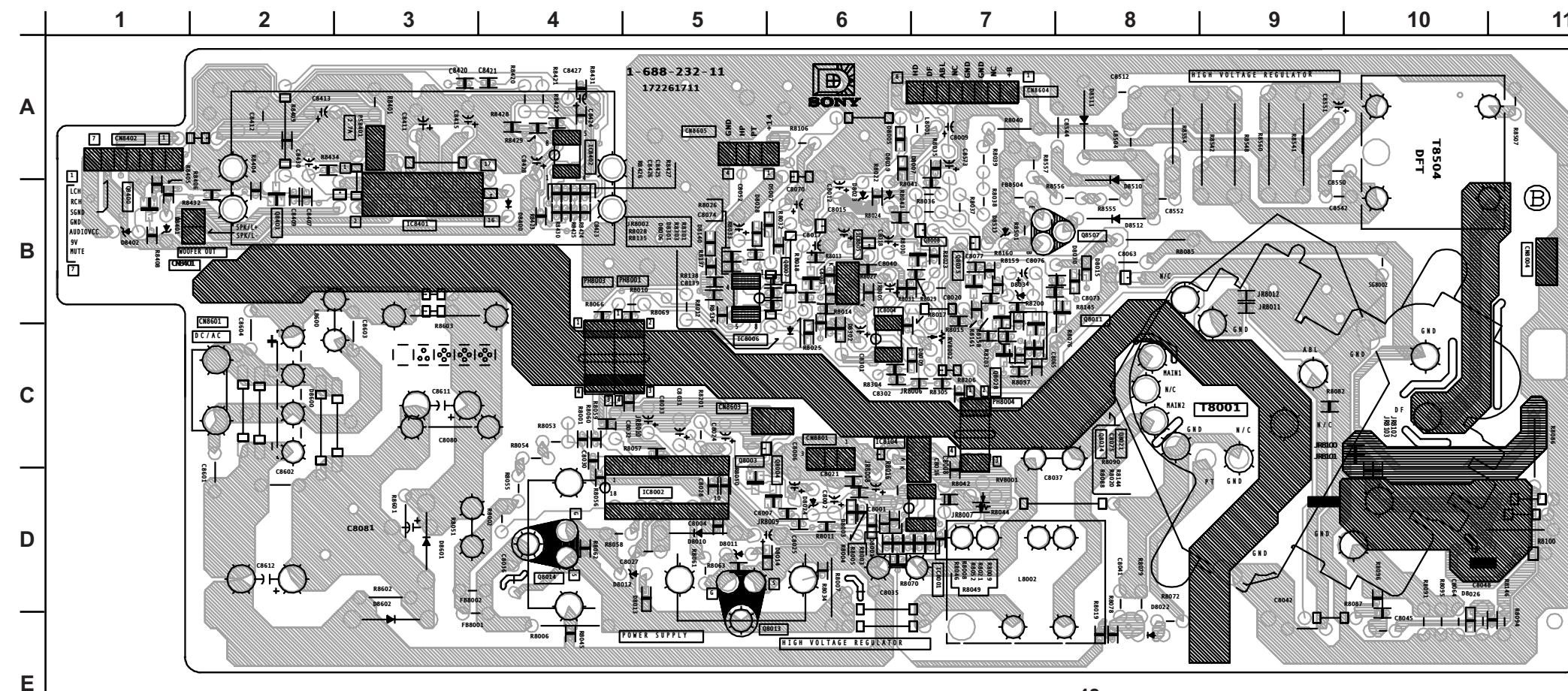

V BOARD SCHEMATIC DIAGRAM

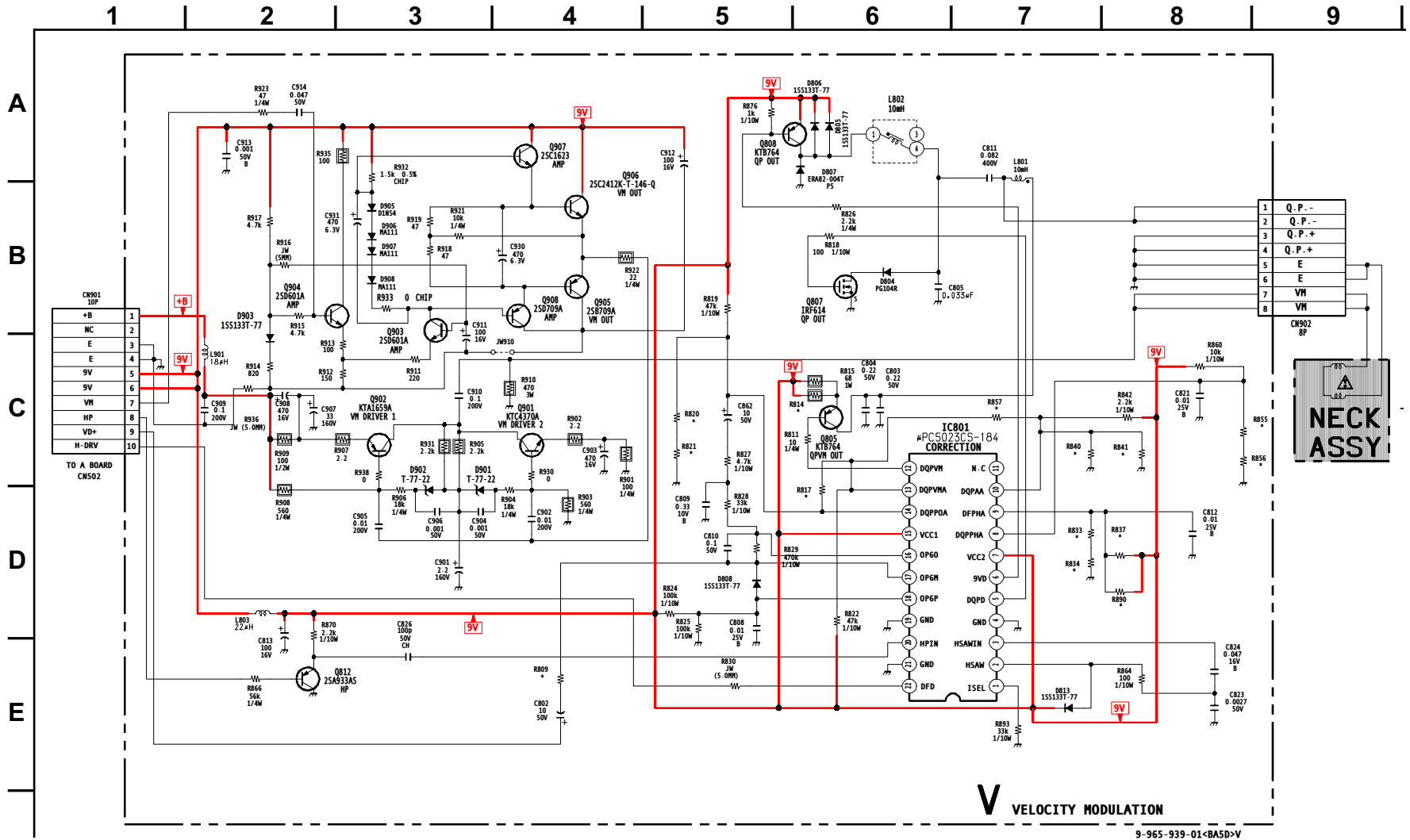

9-965-939-01<BA5D>V



**V COMPONENT SIDE [VELOCITY MODULATION]**

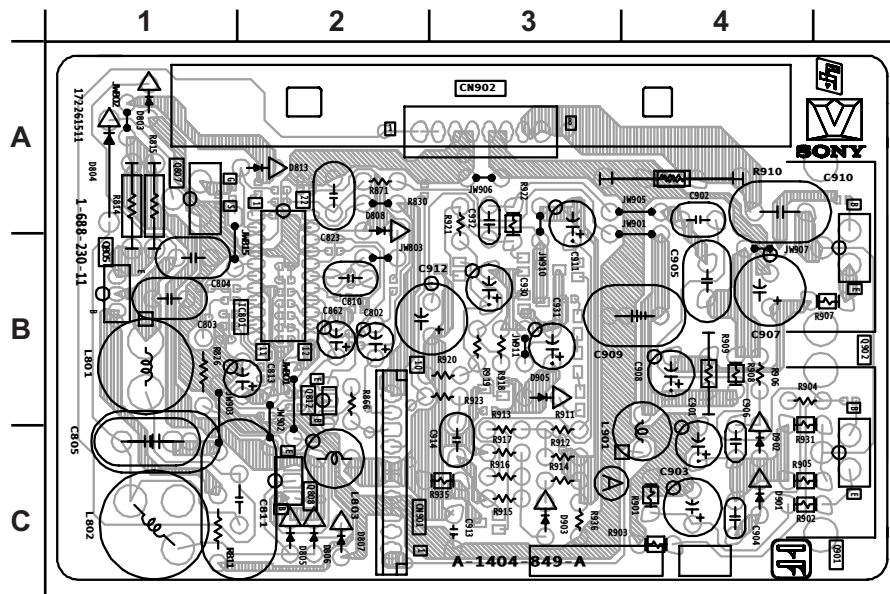

**V BOARD IC VOLTAGE LIST**

IC801		11	N/C
PIN	VOLT	12	3.5
1	7.4	13	3.8
2	2.3	14	4.5
3	4.8	15	9.0
4	GND	16	4.6
5	6.3	17	4.6
6	4.5	18	4.5
7	9.0	19	N/C
8	5.8	20	4.8
9	4.6	21	GND
10	4.8	22	0.3

All voltages are in V.

**V CONDUCTOR SIDE [VELOCITY MODULATION]**

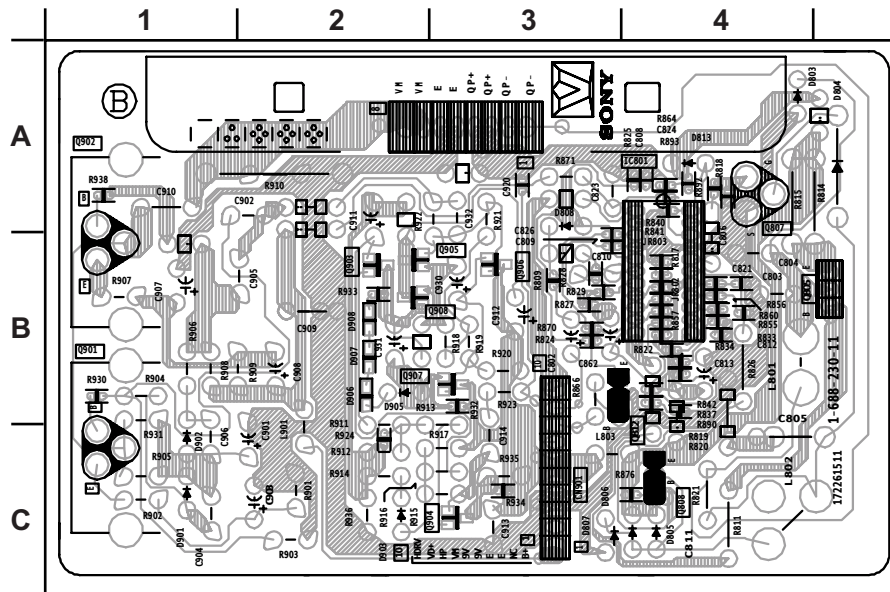

**V BOARD TRANSISTOR VOLTAGE LIST**

	B	C	E
Q805	3.5	1.8	4.2
Q808	8.6	4.3	9.0
Q812	1.3	GND	2.0
Q901	1.4	67.0	0.8
Q902	132.9	67.0	133.4
Q903	1.2	6.2	1.8
Q904	1.2	8.8	1.8
Q905	7.1	0.0	6.7
Q906	7.4	9.0	7.1
Q907	7.4	9.0	8.1
Q908	6.9	0.0	6.2

	D	G	S
Q807	9.5	6.3	GND

All voltages are in V.

# GK BOARD SCHEMATIC DIAGRAM

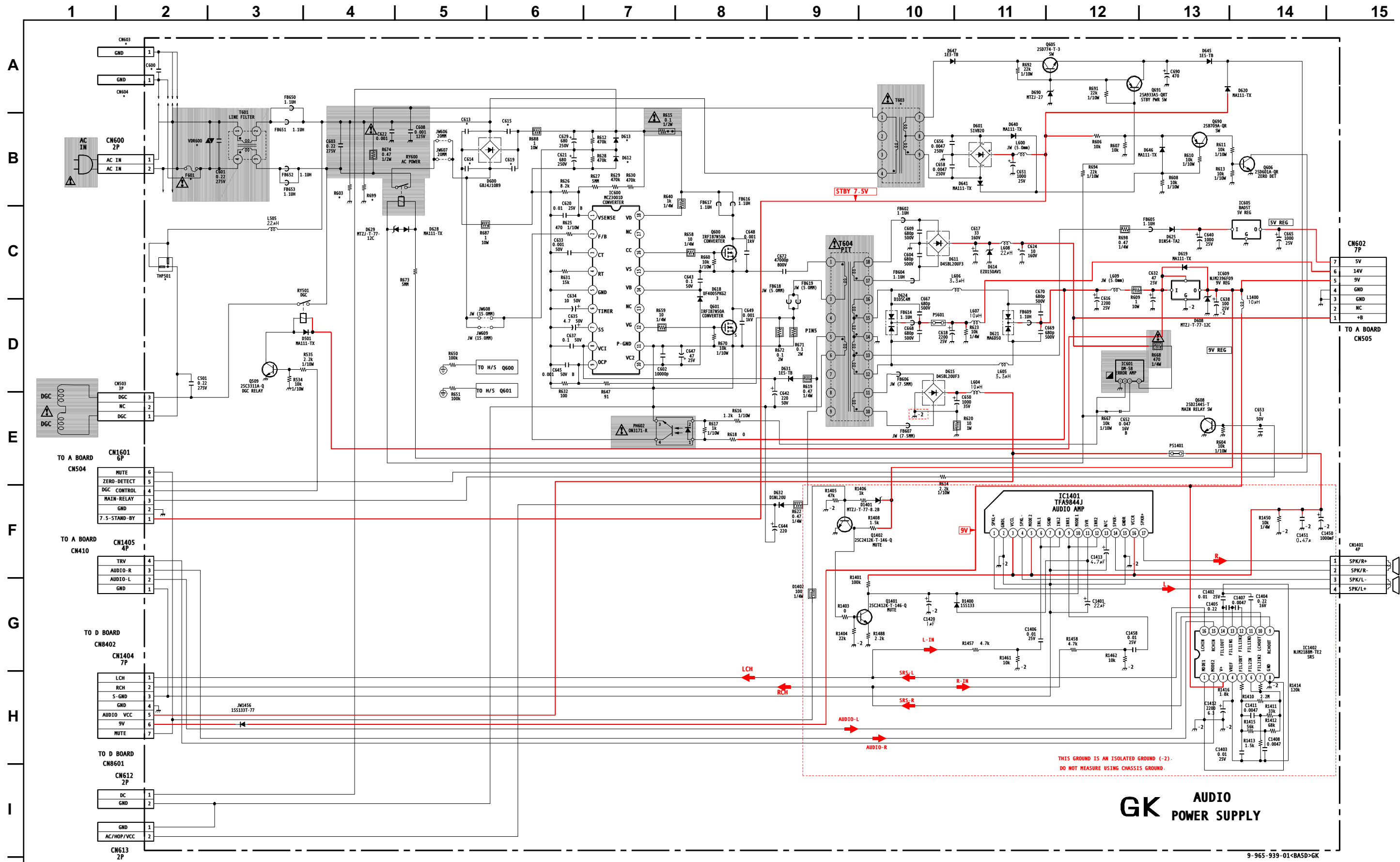

## GK AUDIO POWER SUPPLY

THIS GROUND IS AN ISOLATED GROUND (-2).  
DO NOT MEASURE USING CHASSIS GROUND.

**GK BOARD IC VOLTAGE LIST**

IC600		IC601		2	GND	3	9.0
PIN	VOLT	PIN	VOLT	3	19.6	4	0.0
1	2.8	1	134.6	4	8.3	5	0.0
2	1.9	2	N/C	5	19.6	6	4.5
3	2.3	3	2.4	6	3.2	7	0.0
4	2.6	4	8.4	7	0.0	8	GND
5	GND	5	GND	8	0.0	9	4.5
6	0.0	IC605		9	3.2	10	4.5
7	4.6	PIN	VOLT	10	9.1	11	4.5
8	17.5	I	6.1	11	9.7	12	4.5
9	0.0	O	5.0	12	3.2	13	4.5
10	10.6	G	GND	13	3.3	14	4.4
11	0.0	IC609		14	8.3	15	4.4
12	4.9	PIN	VOLT	15	GND	16	4.5
13	2.3	I	10.5	16	19.6	All voltages are in V.	
14	163.9	O	9.0	17	8.3		
15	153.8	G	GND	IC1402			
16	158.2	IC1401		PIN	VOLT		
17	2.6	PIN	VOLT	1	GND		
18	314.0	1	8.3	2	0.3		

**GK BOARD TRANSISTOR  
VOLTAGE LIST**

	B	C	E
Q509	0.3	10.5	GND
Q605	7.6	18.8	7.6
Q606	0.0	0.5	GND
Q608	0.6	0.0	GND
Q690	6.1	0.5	5.9
Q691	6.9	7.6	7.6
Q1401	8.4	9.2	GND
Q1402	0.0	0.0	GND

	D	G	S
Q600	313.0	160.0	156.0
Q601	155.0	4.9	0.0

All voltages are in V.



**GK COMPONENT SIDE [POWER SUPPLY, AUDIO]**

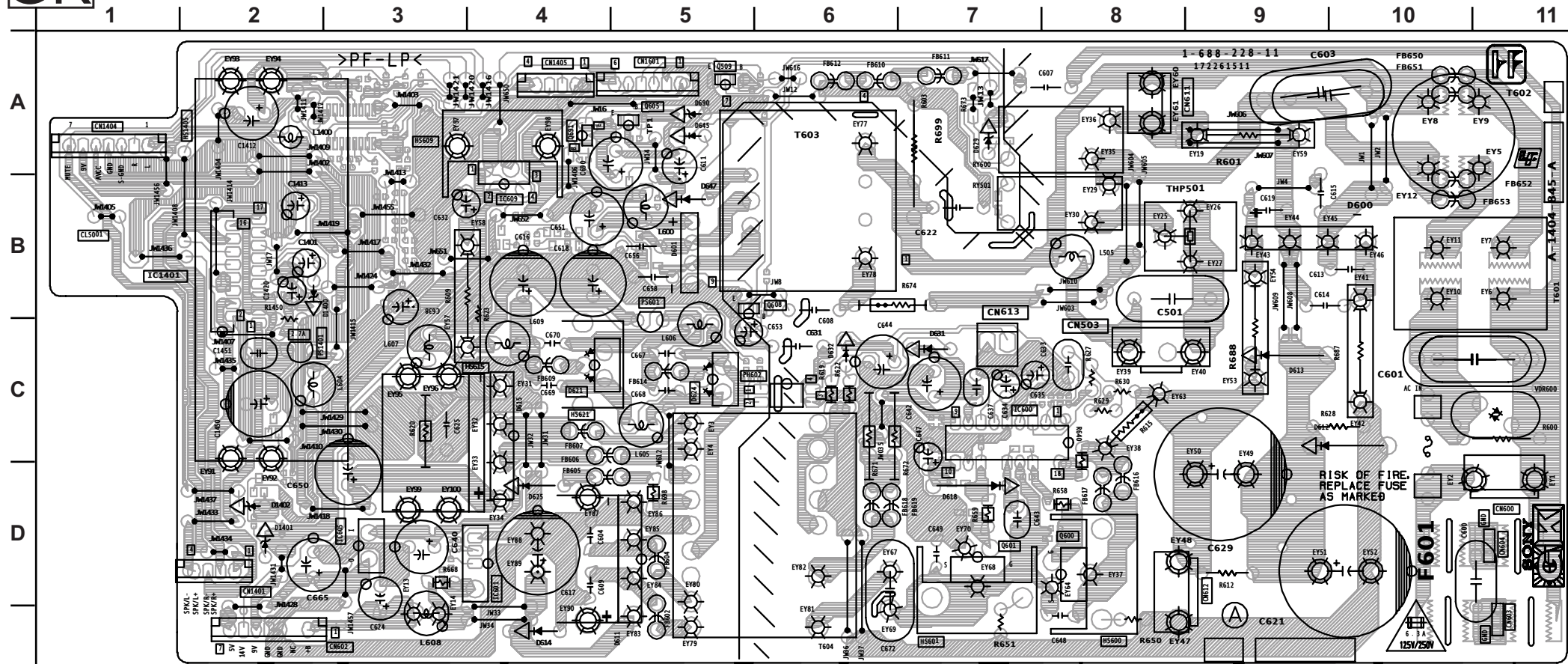

**GK BOARD LOCATOR LIST**

DIODE		IC	
D1400	C-9	IC1401	B-10
D1401	D-10	IC1402	B-10
D1402	D-10	IC600	C-4
D501	B-5	IC601	D-8
D600	B-2	IC605	D-9
D601	B-7	IC609	A-8
D611	D-7		
D612	C-2	TRANSISTOR	
D613	C-2	Q1401	C-10
D614	E-8	Q1402	D-10
D615	C-8	Q509	A-6
D618	D-5	Q600	D-4
D620	B-7	Q601	E-5
D621	C-7	Q605	A-7
D624	C-7	Q606	B-8
D625	D-8	Q608	C-6
D628	A-4	Q690	B-8
D629	A-5	Q691	A-8
D631	C-5		
D632	C-5		
D640	B-7		
D641	B-7		
D645	A-7		
D646	B-8		
D647	B-7		
D690	A-7		

**GK CONDUCTOR SIDE [POWER SUPPLY, AUDIO]**

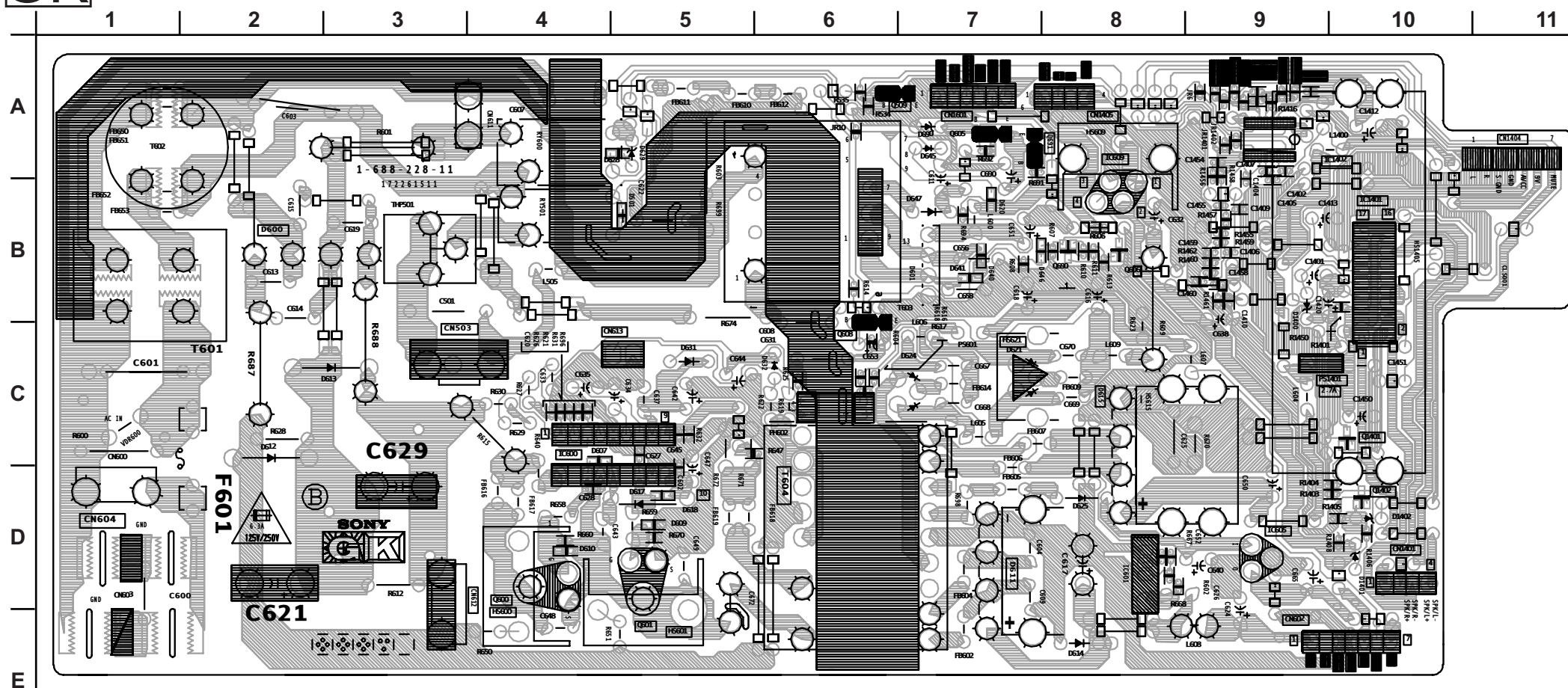

C BOARD SCHEMATIC DIAGRAM

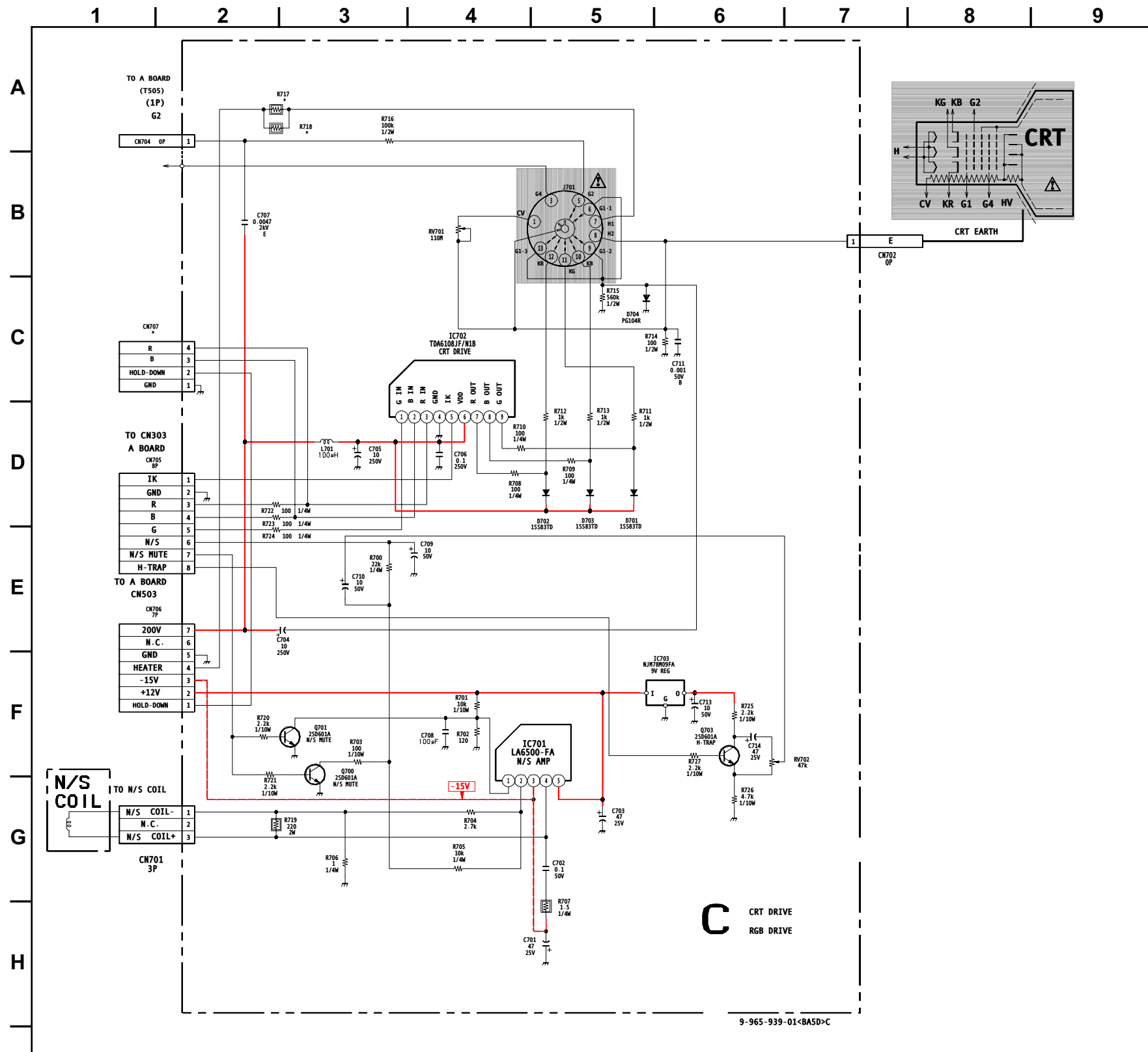

9-965-939-01<BASD>C

C BOARD IC VOLTAGE LIST

IC701		IC703	
PIN	VOLT	PIN	VOLT
1	0.3	I	12.0
2	0.3	0	9.0
3	-13.0	G	GND
4	0.5	All voltages are in V.	
5	12.0		
IC702			
PIN	VOLT		
1	2.2		
2	2.2		
3	2.2		
4	GND		
5	5.0		
6	200.0		
7	139.7		
8	142.0		
9	138.6		

C BOARD WAVEFORMS

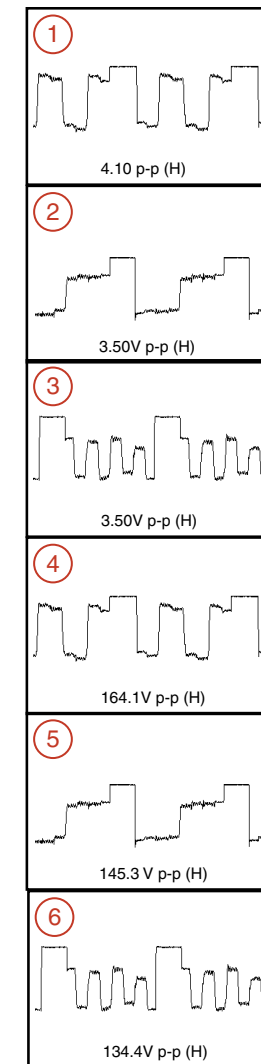

C BOARD TRANSISTOR VOLTAGE LIST

	B	C	E
Q700	0.3	0.8	GND
Q701	0.3	0.3	GND
Q703	6.0	6.5	5.5

All voltages are in V.



**C** COMPONENT SIDE [RGB DRIVE, CRT DRIVE]

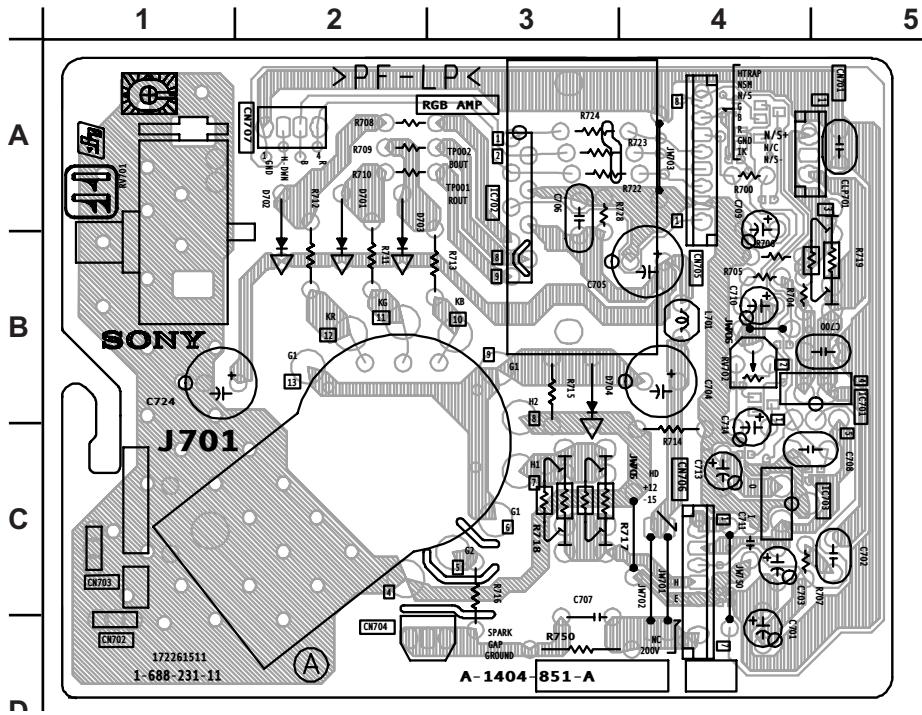

**C** CONDUCTOR SIDE [RGB DRIVE, CRT DRIVE]

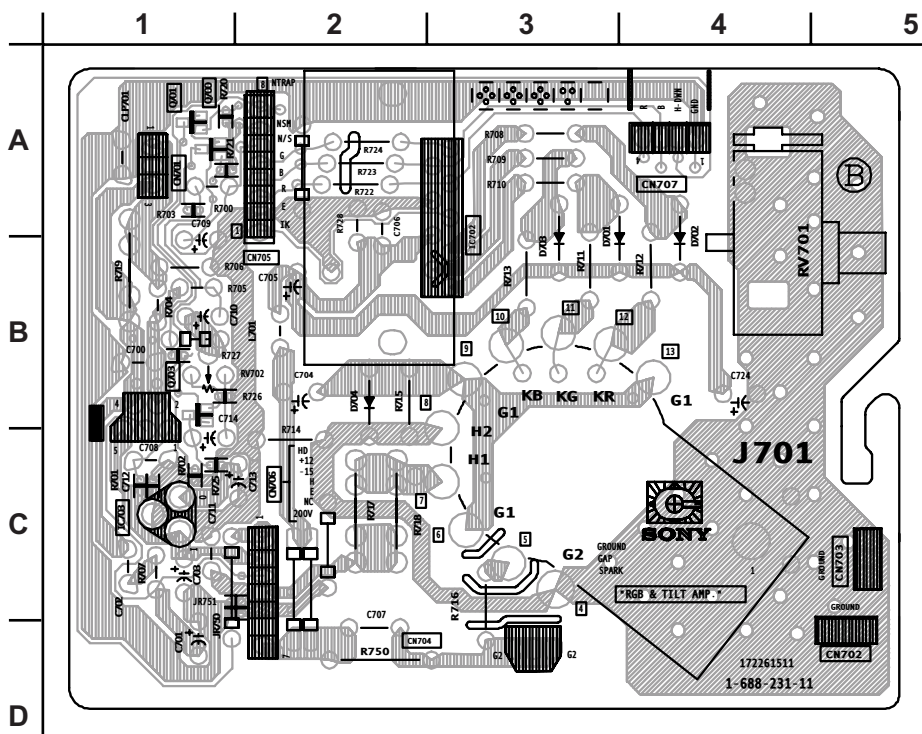

5-5. SEMICONDUCTORS

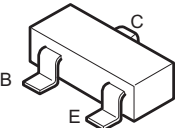
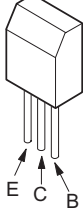
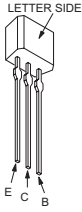
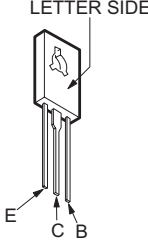
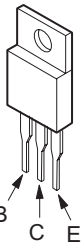
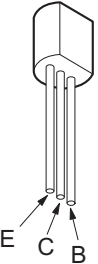
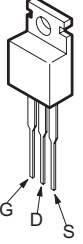
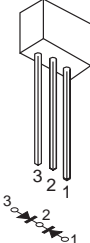
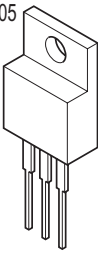
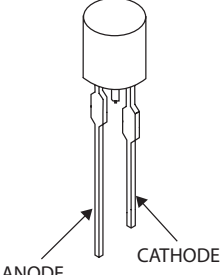
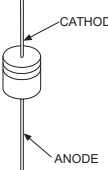
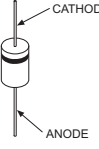
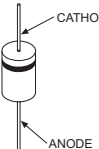
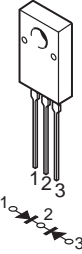
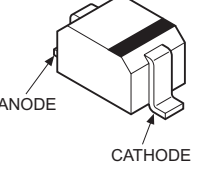
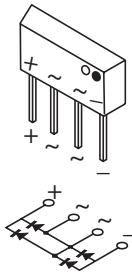
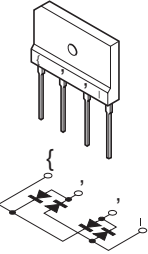
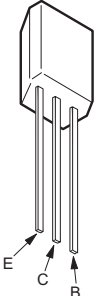
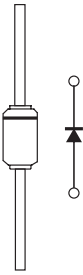
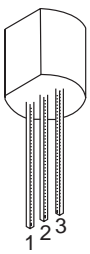
<p>2SB709A-QRS-TX 2SD601A-QRS-TX 2SC2412K-T-146-QR</p> 	<p>2SC3209LK-TP 2SD774-T-34</p> 	<p>2SD1858-Q-TV2 2SC3311A-QRSTA 2SD2144S-TP-UVW</p> 	<p>2SC3840K</p> 	<p>2SC4159-E</p> 
<p>2SA10910-TPE2</p> 	<p>IRF614</p> 	<p>SVC203SPA-AL</p> 	<p>IRFIB7N50A-LF31 2SC5511 2SA2005</p> 	<p>DAL5815</p> 
<p>D1NS4-TA2 D1NS4-TR ERA38-06TP1 ERA82-004TP5 1SS133T-77 MTZJ-T-77-3.3B MTZJ-T-77-3.6B MTZJ-T-77-3.9B MTZJ-T-77-6.2B MTZJ-T-77-6.8B MTZJ-T-77-12C MTZJ-T-77-15B MTZJ-T-77-22</p> 	<p>ERC06-15S MTZJ-T-77-5.1C MTZJ-T-77-5.6C MTZJ-T-77-7.5A MTZJ-T-77-9.1B MTZJ-T-77-10B RGP10-GPKG3 RGP02-17PKG23 RGP15GPKG23</p> 	<p>EL1Z-V1 ERB44-06TP1 ERC04-06SE 1SS83TD 1N4003GA 1N4937/23 GP08DPKG23 PR1004GT RGP10GPKG23 RU4AM-T3</p> 	<p>D10SC4M</p> 	<p>MA111-TX UDZSTE-1710B</p> 
	<p>S1VB20</p> 	<p>D4SB60L-F</p> 	<p>2SC2668-YTP</p> 	<p>MTZJ-T-77-27</p> 
<p>2SA933AS-QRT</p> 				

## SECTION 6: EXPLODED VIEWS

Components not identified by a part number or description are not stocked because they are seldom required for routine service.

The component parts of an assembly are indicated by the reference numbers in the far right column of the parts list and within the dotted lines of the diagram.

\* Items marked with an asterisk are not stocked since they are seldom required for routine service. Expect some delay when ordering these components.







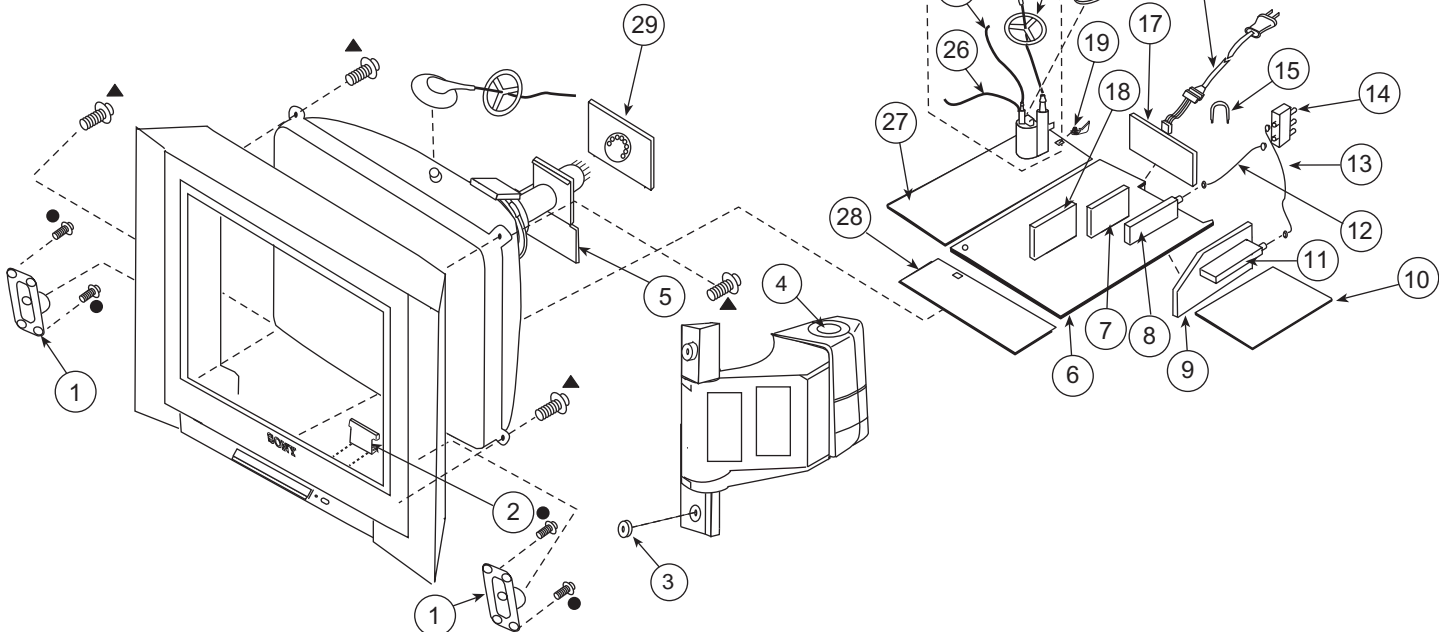

NOTE: The components identified by shading and  mark are critical for safety. Replace only with part number specified.

NOTE: Les composants identifiés par un trame et une marque  sont critiques pour la sécurité. Ne les remplacer que par une pièce portant le numéro spécifié.

## 6-1. CHASSIS (KV-27FV310/29FV310 ONLY)

- ▲ 4-046-765-12 SCREW, TAPPING 7+CROWN WASHER
- 4-388-477-01 SCREW(3X16), TAPPING, +BV WASHER



REF. NO.	PART NO.	DESCRIPTION	REF. NO.	PART NO.	DESCRIPTION	[ASSEMBLY INCLUDES]
1	1-825-417-11	LOUDSPEAKER		16	1-769-796-31	CORD, POWER (WITH CONNECTOR) (KV-29FV310 LATIN SOUTH ONLY)
*	A-1400-251-A	HR (COM) BOARD, MOUNTED	*	17	4-087-877-11	BRACKET, TERMINAL
*	4-374-745-41	CUSHION (A)	*	18	A-1404-854-A	Y BOARD, MOUNTED
4	1-825-416-11	SUB WOOFER SPEAKER (10CM)	19	4-064-646-01	CLIP, CHASSIS	
*	A-1404-848-A	V (VAR) BOARD, MOUNTED	20	1-500-586-11	FILTER, CLAMP (FERRITE CORE)	
*	A-1302-089-A	A BOARD, COMPLETE (ALL EXCEPT KV-29FV310 LATIN SOUTH)	*	21	4-094-669-01	BRACKET, FBT
*	A-1302-166-A	A BOARD, COMPLETE (KV-29FV310 LATIN SOUTH ONLY)		22	4-084-918-01	HOLDER, HV CABLE
*	A-1400-450-A	BC BOARD, MOUNTED		23	1-453-387-21	FBT ASSY/NX-6020//M3J4 (24-26)
8	8-598-593-50	TUNER FSS BTF-WA421		24	1-251-374-14	CAP ASSY, HIGH-VOLTAGE
*	A-1404-846-A	P (VAR) BOARD, MOUNTED		25	1-900-805-19	WIRE ASSY, FOCUS HV
*	A-1404-844-A	GK (VAR) BOARD, MOUNTED (ALL EXCEPT KV-29FV310 LATIN SOUTH)		26	1-900-805-22	CONNECTOR ASSY, G2 HV
*	A-1405-113-A	GK (VAR) BOARD, MOUNTED (KV-29FV310 LATIN SOUTH ONLY)	The high voltage leads associated with the FBT on the following D boards are not included and must be ordered separately (SEE 24-26)			
11	8-598-594-30	TUNER FSS BTF-FA421	*	27	A-1404-852-A	D (VAR) BOARD, MOUNTED (ALL EXCEPT KV-29FV310 LATIN SOUTH)
*	1-555-110-00	CABLE, P-P	*	27	A-1405-114-A	D (VAR) BOARD, MOUNTED (KV-29FV310 LATIN SOUTH ONLY)
*	1-558-539-21	CABLE, P-P	*	28	A-1404-855-A	HU (VAR) BOARD, MOUNTED
	1-771-787-13	SWITCH, RF ANTENNA	*	29	A-1404-850-A	C (VAR) BOARD, MOUNTED
*	4-076-951-01	HINGE, PWB				
	1-827-159-11	POWER CORD WITH CONNECTOR (ALL EXCEPT KV-29FV310 LATIN SOUTH)				

NOTE: The components identified by shading and  $\triangle$  mark are critical for safety. Replace only with part number specified.

NOTE: Les composants identifiés par un trape et une marque  $\triangle$  sont critiques pour la securite. Ne les remplacer que par une piece portant le numero specifie.

## 6-2. PICTURE TUBE (KV-27FV310/29FV310 ONLY)

▲	4-046-765-12	SCREW, TAPPING 7+CROWN WASHER
●	4-388-477-01	SCREW(3X16), TAPPING, +BV WASHER
■	7-685-663-71	SCREW +BVTP 4X16 TYPE2 IT-3
★	7-685-647-79	SCREW +BVTP 3X10 TYPE2 IT-3

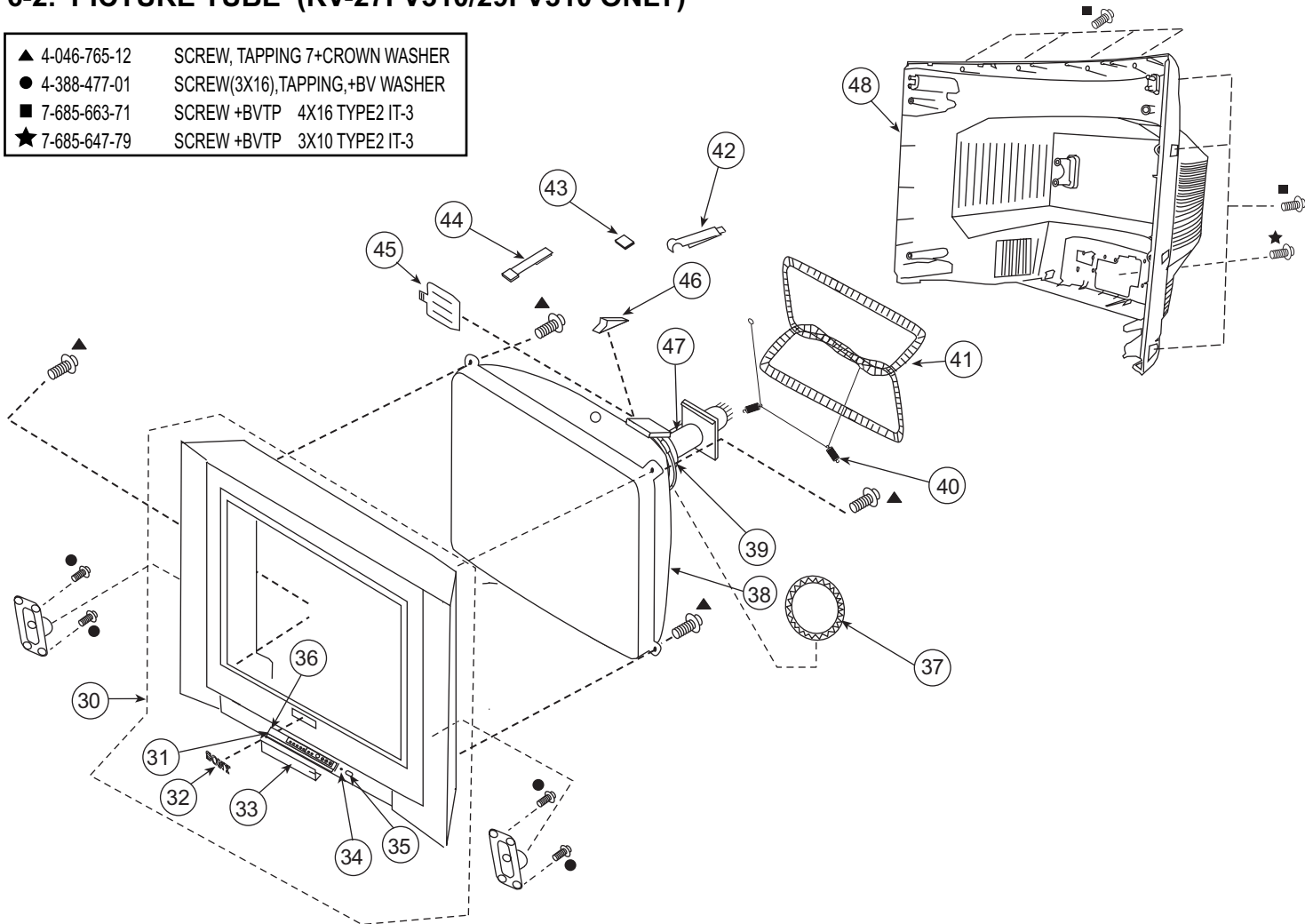

REF. NO.	PART NO.	DESCRIPTION	[ASSEMBLY INCLUDES]	REF. NO.	PART NO.	DESCRIPTION	
30	X-4041-487-1	BEZNET ASSY	(31-36)	40	4-036-329-01	SPRING (B), TENSION	
31	4-087-374-01	SPRING, DOOR		$\triangle$ 41	1-419-156-21	COIL, DEGAUSSING (ALL EXCEPT KV-29FV310 LATIN SOUTH)	
32	4-046-160-11	EMBLEM, SONY (NO.9)		$\triangle$ 41	1-419-523-21	COIL, DEGAUSSING (KV-29FV310 LATIN SOUTH ONLY)	
33	4-087-375-11	DOOR, CONTROL		*	42	4-062-970-12	CLIP (29RSN), DGC
34	4-087-156-01	GUIDE, LIGHT		43	1-452-885-11	MAGNET, LANDING	
35	4-087-150-01	BUTTON, POWER		44	4-083-414-01	PIECE A(110), CONV CORRECT	
36	4-036-880-21	DAMPER		45	4-081-170-01	PLATE, TLH CORRECTION	
$\triangle$ 37	1-452-896-11	COIL, NA ROTATION (RT200)		46	4-053-005-01	SPACER, DY	
$\triangle$ 38	8-735-082-05	CRT 29RSN(SDP) M68LNH050X (ALL EXCEPT KV-29FV310 LATIN SOUTH)		$\triangle$ 47	8-453-011-11	NECK ASSEMBLY NA299-M	
$\triangle$ 38	8-735-083-05	CRT 29RSN(SDP)(SOUTH) M68LNH050X (KV-29FV310 LATIN SOUTH ONLY)		48	4-087-777-22	COVER, REAR	
$\triangle$ 39	8-451-494-41	DY Y29RSA-V					

**NOTE:** The components identified by shading and  $\triangle$  mark are critical for safety. Replace only with part number specified.

**NOTE:** Les composants identifiés par un trape et une marque  $\triangle$  sont critiques pour la securite. Ne les remplacer que par une piece portant le numero specifique.

### 6-3. CHASSIS (KV-32FV310 ONLY)

- $\blacktriangle$  4-046-765-12 SCREW, TAPPING 7+CROWN WASHER
- $\bullet$  4-388-477-01 SCREW(3X16), TAPPING, +BV WASHER

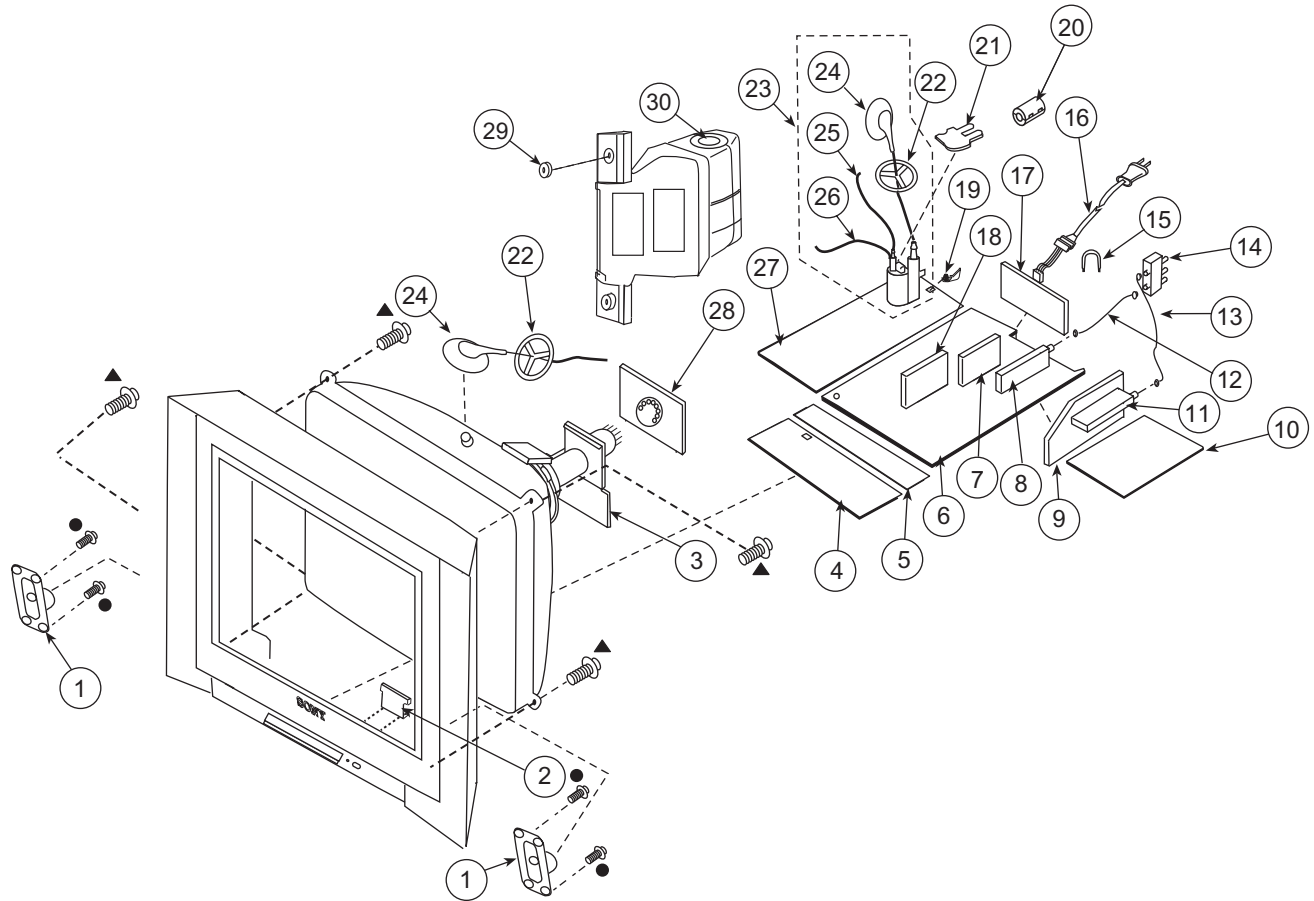

REF. NO.	PART NO.	DESCRIPTION	REF. NO.	PART NO.	DESCRIPTION	[ASSEMBLY INCLUDES]
1	1-825-417-11	LOUDSPEAKER	$\triangle$ 16	1-827-159-11	POWER CORD WITH CONNECTOR	
* 2	A-1400-251-A	HR (COM) BOARD, MOUNTED	* 17	4-087-877-11	BRACKET, TERMINAL	
* 3	A-1404-895-A	V (VAR) BOARD, MOUNTED	* 18	A-1404-854-A	Y BOARD, MOUNTED	
* 4	A-1404-855-A	HU (VAR) BOARD, MOUNTED	19	4-064-646-01	CLIP, CHASSIS	
* 5	A-1404-896-A	HD BOARD, MOUNTED	20	1-500-586-11	FILTER, CLAMP (FERRITE CORE)	
* 6	A-1302-106-A	A BOARD, COMPLETE	* 21	4-094-669-01	BRACKET, FBT	
* 7	A-1400-450-A	BC BOARD, MOUNTED	22	4-084-918-01	HOLDER, HV CABLE	
8	8-598-593-50	TUNER FSS BTF-WA421	$\triangle$ 23	1-453-387-21	FBT ASSY NX-6020//M3J4	(24-26)
* 9	A-1404-846-A	P (VAR) BOARD, MOUNTED	$\triangle$ 24	1-251-715-22	CAP ASSY, HIGH-VOLTAGE	
* 10	A-1404-844-A	GK (VAR) BOARD, MOUNTED	$\triangle$ 25	1-900-805-19	WIRE ASSY, FOCUS HV	
11	8-598-594-30	TUNER FSS BTF-FA421	$\triangle$ 26	1-900-805-22	CONNECTOR ASSY, G2 HV	
* 12	1-555-110-00	CABLE, P-P	* 27	A-1404-897-A	D (VAR) BOARD, MOUNTED	The high voltage leads associated with the FBT on the D board are not included and must be ordered separately (SEE 24-26)
* 13	1-558-539-21	CABLE, P-P	* 28	A-1405-169-A	C (VAR) BOARD, MOUNTED	
$\triangle$ 14	1-771-787-13	SWITCH, RF ANTENNA	29	4-374-745-41	CUSHION (A)	
* 15	4-076-951-01	HINGE, PWB	30	1-825-416-11	SUB WOOFER SPEAKER (10CM)	

**NOTE:** The components identified by shading and  $\triangle$  mark are critical for safety. Replace only with part number specified.

**NOTE:** Les composants identifiés par un trape et une marque  $\triangle$  sont critiques pour la securite. Ne les remplacer que par une piece portant le numero specifique.

## 6-4. PICTURE TUBE (KV-32FV310 ONLY)

▲	4-046-765-12	SCREW, TAPPING 7+CROWN WASHER
●	4-388-477-01	SCREW(3X16), TAPPING, +BV WASHER
■	7-685-663-71	SCREW +BVTP 4X16 TYPE2 IT-3
★	7-685-647-79	SCREW +BVTP 3X10 TYPE2 IT-3

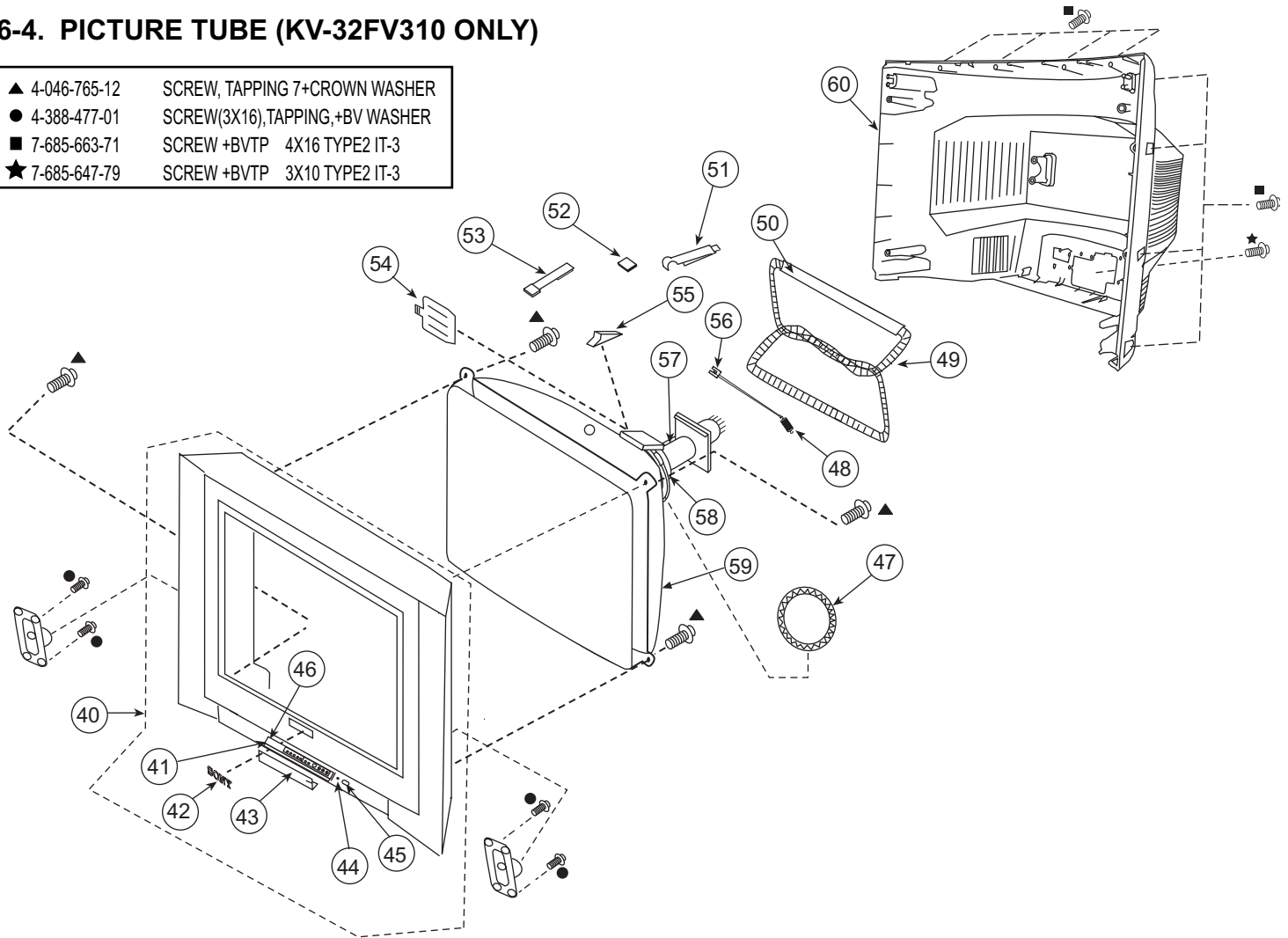

REF. NO.	PART NO.	DESCRIPTION	[ASSEMBLY INCLUDES]	REF. NO.	PART NO.	DESCRIPTION
40	X-4041-404-1	BEZNET ASSY	(41-46)	51	4-065-895-11	HOLDER, DGC
41	4-087-374-01	SPRING, DOOR		52	1-452-885-11	MAGNET, LANDING
42	4-046-160-11	EMBLEM, SONY (NO.9)		53	4-083-414-01	PIECE A(110), CONV CORRECT
43	4-087-375-11	DOOR, CONTROL		54	4-081-170-01	PLATE, TLH CORRECTION
44	4-087-156-01	GUIDE, LIGHT		55	4-053-005-01	SPACER, DY
45	4-087-150-01	BUTTON, POWER		56	4-082-640-01	HOOK, GROUND WIRE
46	4-036-880-21	DAMPER		57	8-453-007-41	NECK ASSEMBLY NA324-M4
$\triangle$ 47	1-452-896-11	COIL, NA ROTATION (RT200)		58	8-451-499-41	DY Y34RSA-V
48	4-082-641-01	SPRING, 45MM		59	8-735-066-05	CRT 34RSN(SDP) A80LPD50X
$\triangle$ 49	1-428-988-11	DEGAUSSING COIL (32 120V)		60	4-087-878-21	COVER, REAR
* 50	4-074-576-01	CUSHION, DGC				



NOTE: The components identified by shading and  $\triangle$  mark are critical for safety. Replace only with part number specified.

NOTE: Les composants identifiés par un trame et une marque  $\triangle$  sont critiques pour la sécurité. Ne les remplacer que par une pièce portant le numéro spécifié.

### 6-5. CHASSIS (KV-36FV310 ONLY)

- $\blacktriangle$  4-046-765-12 SCREW, TAPPING 7+CROWN WASHER
- $\bullet$  4-388-477-01 SCREW(3X16), TAPPING, +BV WASHER

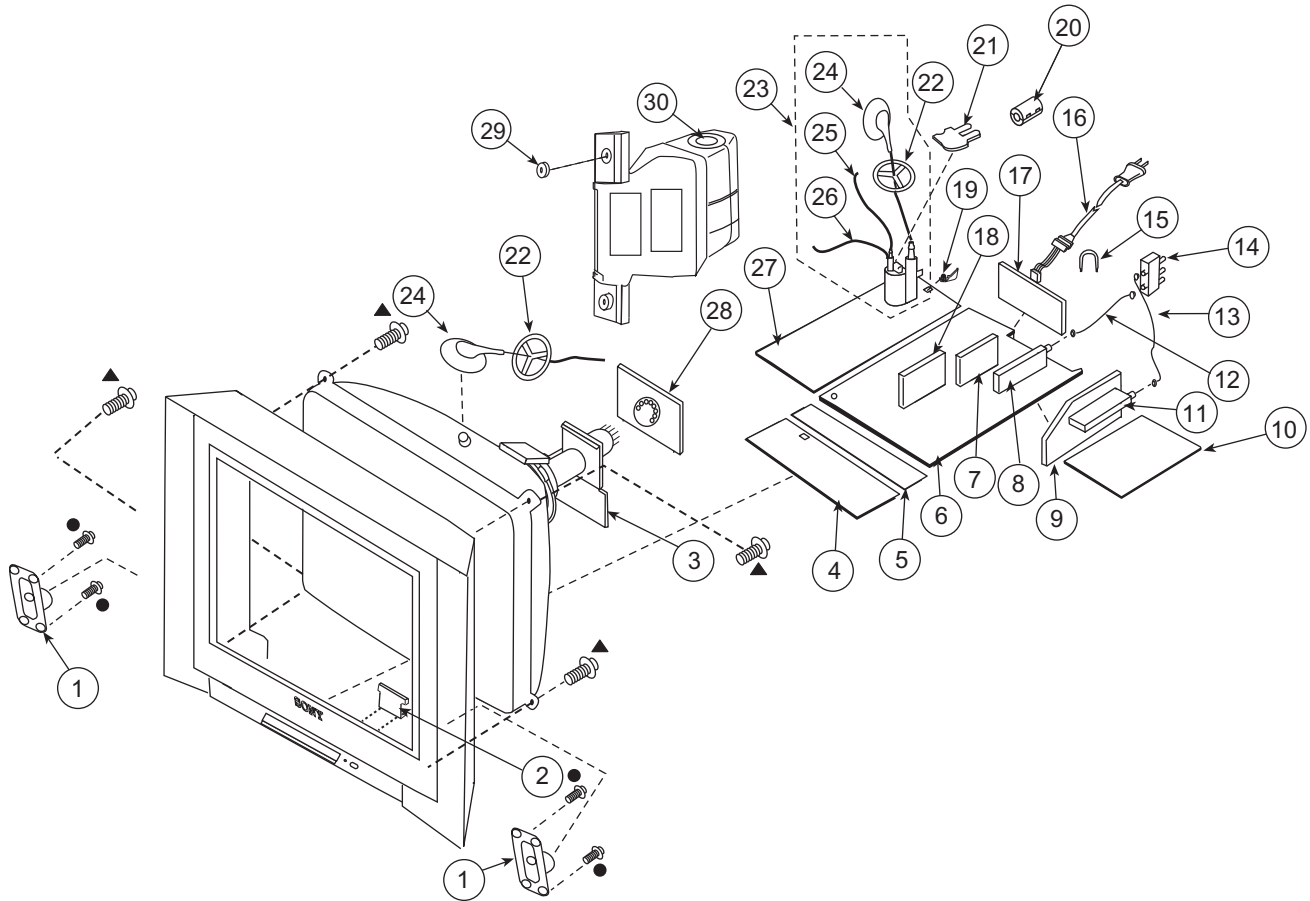

REF. NO.	PART NO.	DESCRIPTION	REF. NO.	PART NO.	DESCRIPTION	[ASSEMBLY INCLUDES]
1	1-825-417-11	LOUDSPEAKER	$\triangle$ 16	1-827-159-11	POWER CORD WITH CONNECTOR	
* 2	A-1400-251-A	HR (COM) BOARD, MOUNTED	* 17	4-087-877-11	BRACKET, TERMINAL	
* 3	A-1404-955-A	V (VAR) BOARD, MOUNTED	* 18	A-1404-854-A	Y BOARD, MOUNTED	
* 4	A-1404-855-A	HU (VAR) BOARD, MOUNTED	19	4-064-646-01	CLIP, CHASSIS	
* 5	A-1404-896-A	HD BOARD, MOUNTED	20	1-500-586-11	FILTER, CLAMP (FERRITE CORE)	
* 6	A-1302-129-A	A BOARD, COMPLETE	* 21	4-094-669-01	BRACKET, FBT	
* 7	A-1400-450-A	BC BOARD, MOUNTED	22	4-084-918-01	HOLDER, HV CABLE	
8	8-598-593-50	TUNER FSS BTF-WA421	$\triangle$ 23	1-453-389-31	FBT ASSY NX-6020//M3C4	(24-26)
* 9	A-1404-846-A	P (VAR) BOARD, MOUNTED	$\triangle$ 24	1-251-715-32	CAP ASSY, HIGH-VOLTAGE	
* 10	A-1404-956-A	GK (VAR) BOARD, MOUNTED	$\triangle$ 25	1-900-805-19	WIRE ASSY, FOCUS HV	
11	8-598-594-30	TUNER FSS BTF-FA421	$\triangle$ 26	1-900-805-22	CONNECTOR ASSY, G2 HV	
* 12	1-555-110-00	CABLE, P-P	* 27	A-1404-897-A	D (VAR) BOARD, MOUNTED	The high voltage leads associated with the FBT on the D board are not included and must be ordered separately (SEE 24-26)
* 13	1-558-539-21	CABLE, P-P	* 28	A-1405-222-A	C (VAR) BOARD, MOUNTED	
$\triangle$ 14	1-771-787-13	SWITCH, RF ANTENNA	* 29	4-374-745-41	CUSHION (A)	
* 15	4-076-951-01	HINGE, PWB	30	1-825-416-11	SUB WOOFER SPEAKER (10CM)	

**NOTE:** The components identified by shading and  $\triangle$  mark are critical for safety. Replace only with part number specified.

**NOTE:** Les composants identifiés par un trape et une marque  $\triangle$  sont critiques pour la securite. Ne les remplacer que par une piece portant le numero specifie.

### 6-6. PICTURE TUBE (KV-36FV310 ONLY)

- $\blacktriangle$  4-046-765-12 SCREW, TAPPING 7+CROWN WASHER
- $\bullet$  4-388-477-01 SCREW(3X16),TAPPING,+BV WASHER
- $\blacksquare$  7-685-663-79 SCREW +BVTP 4X16 TYPE2 TT(B)
- $\star$  7-685-648-79 SCREW +BVTP 3X12 TYPE2 IT-3

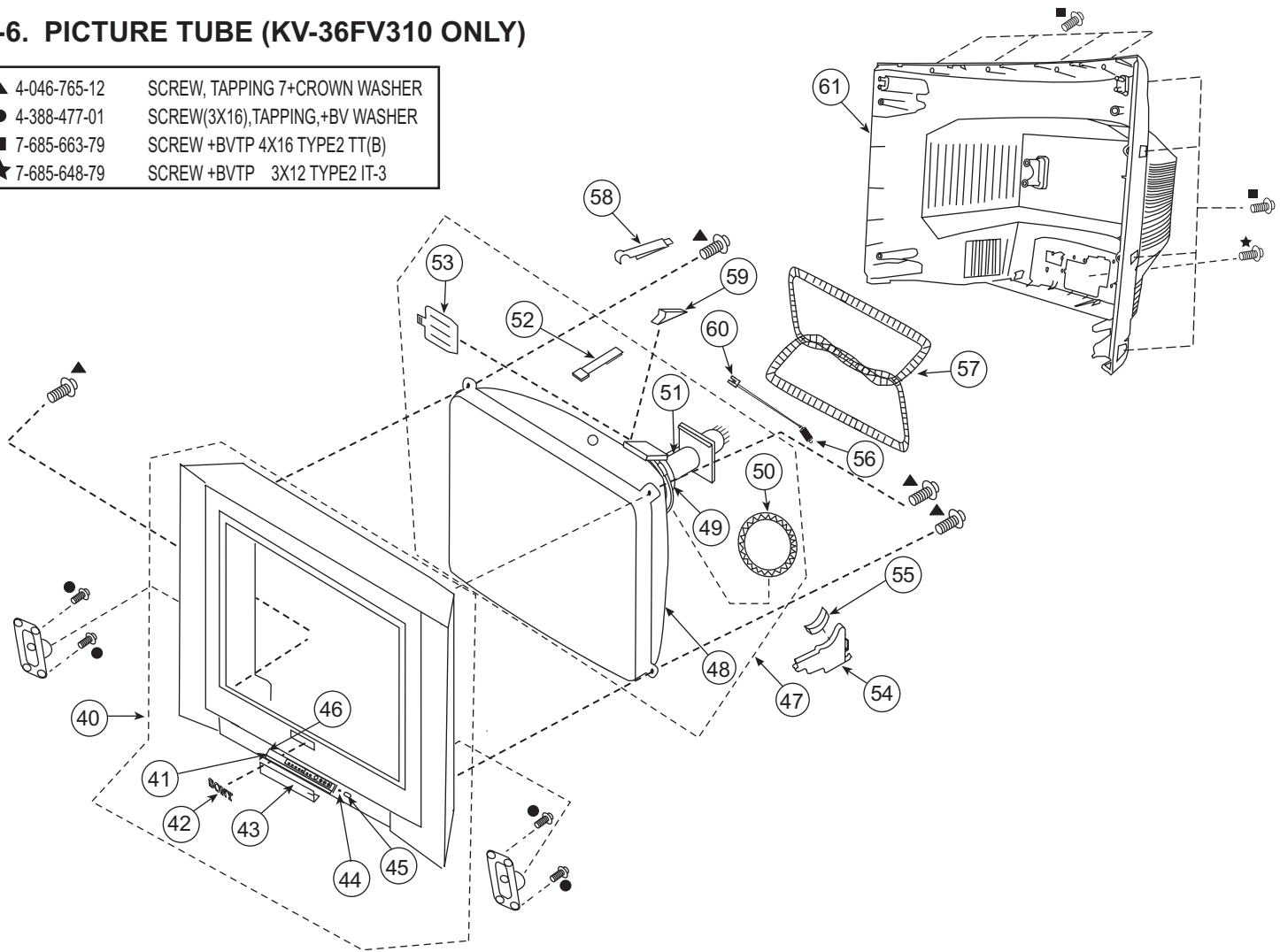

REF. NO.	PART NO.	DESCRIPTION	[ASSEMBLY INCLUDES]	REF. NO.	PART NO.	DESCRIPTION
40	X-4041-548-1	BEZNET ASSY	(41-46)	$\triangle$ 49	8-451-506-22	DY Y38RSA-V
41	4-087-374-01	SPRING, DOOR		$\triangle$ 50	1-452-896-11	COIL, NA ROTATION (RT200)
42	4-046-160-11	EMBLEM, SONY (NO.9)		$\triangle$ 51	8-453-007-41	NECK ASSEMBLY NA324-MA
43	4-087-375-21	DOOR, CONTROL		52	4-085-128-01	PIECE A(110), CONV CORRECT
44	4-087-156-01	GUIDE, LIGHT		53	2-163-920-01	PLATE, TLH CORRECTION
45	4-087-150-01	BUTTON, POWER		54	4-086-875-02	SUPPORTER, CRT
46	4-036-880-11	DAMPER		55	4-088-879-01	CUSHION, 36 CRT SUPPORTER
$\triangle$ 47	8-735-081-61	ITC 38RSN-A1M (KV-36FV310 HAWAII ONLY)	(48-53)	56	4-082-641-01	SPRING, 45MM
$\triangle$ 47	8-735-048-61	ITC 38RSN-A1 (KV-36FV310 US & CND ONLY)	(48-53)	$\triangle$ 57	1-428-987-11	DEGAUSSING COIL (36 120V)
$\triangle$ 48	8-735-081-05	CRT 38RSN (FOR TAIWAN, ETC.) A90LPW80X (KV-36FV310 HAWAII ONLY)		58	4-065-895-04	HOLDER, DGC
$\triangle$ 48	8-735-048-05	CRT 38RSN A90LPW80X (KV-36FV310 US & CND ONLY)		59	4-053-093-01	SPACER, DY
				60	4-082-640-01	HOOK, GROUND WIRE
				61	4-086-697-21	COVER, REAR

## SECTION 7: ELECTRICAL PARTS LIST

NOTE: The components identified by shading and  $\triangle$  mark are critical for safety. Replace only with part number specified.

NOTE: Les composants identifiés par un trame et une marque  $\triangle$  sont critiques pour la sécurité. Ne les remplacer que par une pièce portant le numéro spécifique.

The components in this manual identified by the following symbol:  $\boxtimes$  indicate parts that have been carefully factory-selected to satisfy regulations regarding X-ray radiation for each set.

Should replacement be required for one of these components, replace only with the value originally used.

\* Items marked with an asterisk are not stocked since they are seldom required for routine service. Expect some delay when ordering these components.

## RESISTORS

- All resistors are in ohms
- F : nonflammable
- All variable and adjustable resistors have characteristic curve B, unless otherwise noted.



When ordering parts by reference number, please include the board name.

REF. NO.	PART NO.	DESCRIPTION	VALUES	REF. NO.	PART NO.	DESCRIPTION	VALUES
<b>A</b>				C036	1-162-964-11	CERAMIC CHIP	0.001 $\mu$ F 10% 50V
*	<b>A-1302-089-A</b>	<b>A BOARD, COMPLETE (KV-27FV310/29FV310(N) ONLY)</b>		C037	1-164-230-11	CERAMIC CHIP	220pF 5% 50V
*	<b>A-1302-106-A</b>	<b>A BOARD, COMPLETE(KV-32FV310 ONLY)</b>		C038	1-164-230-11	CERAMIC CHIP	220pF 5% 50V
*	<b>A-1302-129-A</b>	<b>A BOARD, COMPLETE(KV-36FV310 ONLY)</b>		C039	1-162-964-11	CERAMIC CHIP	0.001 $\mu$ F 10% 50V
*	<b>A-1302-166-A</b>	<b>A BOARD, COMPLETE(KV-29FV310(S) ONLY)</b>		C041	1-164-230-11	CERAMIC CHIP	220pF 5% 50V
	4-382-854-11	SCREW (M3X10), P, SW (+)		C043	1-164-230-11	CERAMIC CHIP	220pF 5% 50V
	<b>CAPACITOR</b>			C044	1-164-230-11	CERAMIC CHIP	220pF 5% 50V
C001	1-164-315-11	CERAMIC CHIP	470pF 5% 50V	C045	1-126-964-11	ELECT	10 $\mu$ F 20% 50V
C002	1-164-230-11	CERAMIC CHIP	220pF 5% 50V	C046	1-126-964-11	ELECT	10 $\mu$ F 20% 50V
C003	1-107-826-11	CERAMIC CHIP	0.1 $\mu$ F 10% 16V	C047	1-126-941-11	ELECT	470 $\mu$ F 20% 25V
C004	1-126-947-11	ELECT	47 $\mu$ F 20% 35V	C048	1-115-416-11	CERAMIC CHIP	0.001 $\mu$ F 5% 25V
C005	1-164-739-11	CERAMIC CHIP	560pF 5% 50V	C049	1-126-964-11	ELECT	10 $\mu$ F 20% 50V
C006	1-162-964-11	CERAMIC CHIP	0.001 $\mu$ F 10% 50V	C050	1-126-941-11	ELECT	470 $\mu$ F 20% 25V
C007	1-164-230-11	CERAMIC CHIP	220pF 5% 50V	C051	1-126-947-11	ELECT	47 $\mu$ F 20% 35V
C008	1-126-960-11	ELECT	1 $\mu$ F 20% 50V	C052	1-162-968-11	CERAMIC CHIP	0.0047 $\mu$ F 10% 50V
C009	1-162-964-11	CERAMIC CHIP	0.001 $\mu$ F 10% 50V	C053	1-135-834-91	CERAMIC CHIP	2.2 $\mu$ F 6.3V
C014	1-162-975-11	CERAMIC CHIP	24pF 5% 50V	C054	1-126-963-11	ELECT	4.7 $\mu$ F 20% 50V
C015	1-162-975-11	CERAMIC CHIP	24pF 5% 50V	C055	1-126-933-11	ELECT	100 $\mu$ F 20% 16V
C016	1-126-935-11	ELECT	470 $\mu$ F 20% 16V	C056	1-135-834-91	CERAMIC CHIP	2.2 $\mu$ F 6.3V
C017	1-162-966-11	CERAMIC CHIP	0.0022 $\mu$ F 10% 50V	C057	1-135-834-91	CERAMIC CHIP	2.2 $\mu$ F 6.3V
C018	1-164-230-11	CERAMIC CHIP	220pF 5% 50V	C060	1-164-230-11	CERAMIC CHIP	220pF 5% 50V
C020	1-164-230-11	CERAMIC CHIP	220pF 5% 50V	C062	1-125-837-91	CERAMIC CHIP	1 $\mu$ F 10% 6.3V
C026	1-164-230-11	CERAMIC CHIP	220pF 5% 50V	C065	1-125-891-11	CERAMIC CHIP	0.47 $\mu$ F 10% 10V
C027	1-162-964-11	CERAMIC CHIP	0.001 $\mu$ F 10% 50V	C101	1-115-416-11	CERAMIC CHIP	0.001 $\mu$ F 5% 25V
C028	1-162-964-11	CERAMIC CHIP	0.001 $\mu$ F 10% 50V	C102	1-115-416-11	CERAMIC CHIP	0.001 $\mu$ F 5% 25V
C029	1-126-960-11	ELECT	1 $\mu$ F 20% 50V	C111	1-164-230-11	CERAMIC CHIP	220pF 5% 50V
C030	1-165-176-11	CERAMIC CHIP	0.047 $\mu$ F 10% 16V	C120	1-162-915-11	CERAMIC CHIP	10pF 0.50pF 50V
C031	1-164-230-11	CERAMIC CHIP	220pF 5% 50V	C121	1-162-915-11	CERAMIC CHIP	10pF 0.50pF 50V
C032	1-126-964-11	ELECT	10 $\mu$ F 20% 50V	C122	1-107-826-11	CERAMIC CHIP	0.1 $\mu$ F 10% 16V
C033	1-125-837-91	CERAMIC CHIP	1 $\mu$ F 10% 6.3V	C133	1-164-230-11	CERAMIC CHIP	220pF 5% 50V
C034	1-162-964-11	CERAMIC CHIP	0.001 $\mu$ F 10% 50V	C200	1-107-826-11	CERAMIC CHIP	0.1 $\mu$ F 10% 16V
C035	1-162-964-11	CERAMIC CHIP	0.001 $\mu$ F 10% 50V	C201	1-107-826-11	CERAMIC CHIP	0.1 $\mu$ F 10% 16V
				C202	1-107-826-11	CERAMIC CHIP	0.1 $\mu$ F 10% 16V
				C203	1-107-826-11	CERAMIC CHIP	0.1 $\mu$ F 10% 16V
				C206	1-107-826-11	CERAMIC CHIP	0.1 $\mu$ F 10% 16V



REF. NO.	PART NO.	DESCRIPTION	VALUES			REF. NO.	PART NO.	DESCRIPTION	VALUES		
C207	1-107-826-11	CERAMIC CHIP	0.1μF	10%	16V	C360	1-126-960-11	ELECT	1μF	20%	50V
C208	1-107-826-11	CERAMIC CHIP	0.1μF	10%	16V	C365	1-162-117-00	CERAMIC	100pF	10%	500V
C209	1-107-826-11	CERAMIC CHIP	0.1μF	10%	16V	C366	1-113-619-11	CERAMIC CHIP	0.47μF		10V
C210	1-126-963-11	ELECT	4.7μF	20%	50V	C367	1-113-619-11	CERAMIC CHIP	0.47μF		10V
C211	1-126-963-11	ELECT	4.7μF	20%	50V	C368	1-113-619-11	CERAMIC CHIP	0.47μF		10V
C212	1-126-963-11	ELECT	4.7μF	20%	50V	C371	1-126-964-11	ELECT	10μF	20%	50V
C213	1-126-963-11	ELECT	4.7μF	20%	50V	C372	1-162-970-11	CERAMIC CHIP	0.01μF	10%	25V
C302	1-126-963-11	ELECT	4.7μF	20%	50V	C373	1-104-665-11	ELECT	100μF	20%	25V
C303	1-107-826-11	CERAMIC CHIP	0.1μF	10%	16V	C374	1-107-826-11	CERAMIC CHIP	0.1μF	10%	16V
C305	1-107-826-11	CERAMIC CHIP	0.1μF	10%	16V	C393	1-107-826-11	CERAMIC CHIP	0.1μF	10%	16V
C307	1-126-964-11	ELECT	10μF	20%	50V	C397	1-126-935-11	ELECT	470μF	20%	16V
C308	1-126-964-11	ELECT	10μF	20%	50V	C400	1-128-934-91	CERAMIC CHIP	0.33μF	20%	10V
C309	1-107-826-11	CERAMIC CHIP	0.1μF	10%	16V	C401	1-164-227-11	CERAMIC CHIP	0.022μF	10%	25V
C310	1-126-964-11	ELECT	10μF	20%	50V	C402	1-164-174-11	CERAMIC CHIP	0.0082μF	10%	25V
C311	1-126-947-11	ELECT	47μF	20%	35V	C403	1-162-967-11	CERAMIC CHIP	0.0033μF	10%	50V
C312	1-126-964-11	ELECT	10μF	20%	50V	C404	1-162-967-11	CERAMIC CHIP	0.0033μF	10%	50V
C313	1-107-826-11	CERAMIC CHIP	0.1μF	10%	16V	C405	1-164-677-11	CERAMIC CHIP	0.033μF	10%	16V
C314	1-126-964-11	ELECT	10μF	20%	50V	C406	1-164-677-11	CERAMIC CHIP	0.033μF	10%	16V
C315	1-126-964-11	ELECT	10μF	20%	50V	C407	1-115-412-11	CERAMIC CHIP	680pF	5%	25V
C319	1-107-826-11	CERAMIC CHIP	0.1μF	10%	16V	C408	1-115-412-11	CERAMIC CHIP	680pF	5%	25V
C320	1-126-959-11	ELECT	0.47μF	20%	50V	C409	1-125-891-11	CERAMIC CHIP	0.47μF	10%	10V
C321	1-126-947-11	ELECT	47μF	20%	35V	C410	1-125-891-11	CERAMIC CHIP	0.47μF	10%	10V
C322	1-107-826-11	CERAMIC CHIP	0.1μF	10%	16V	C411	1-128-934-91	CERAMIC CHIP	0.33μF	20%	10V
C330	1-126-964-11	ELECT	10μF	20%	50V	C412	1-126-961-11	ELECT	2.2μF	20%	50V
C333	1-126-963-11	ELECT	4.7μF	20%	50V	C413	1-126-960-11	ELECT	1μF	20%	50V
C335	1-162-918-11	CERAMIC CHIP	18pF	5%	50V	C414	1-126-960-11	ELECT	1μF	20%	50V
C337	1-164-315-11	CERAMIC CHIP	470pF	5%	50V	C415	1-126-960-11	ELECT	1μF	20%	50V
C338	1-107-826-11	CERAMIC CHIP	0.1μF	10%	16V	C416	1-126-960-11	ELECT	1μF	20%	50V
C339	1-113-619-11	CERAMIC CHIP	0.47μF		10V	C417	1-115-416-11	CERAMIC CHIP	0.001μF	5%	25V
C340	1-126-767-11	ELECT	1000μF	20%	16V	C418	1-126-963-11	ELECT	4.7μF	20%	50V
C341	1-126-947-11	ELECT	47μF	20%	35V	C419	1-104-666-11	ELECT	220μF	20%	25V
C343	1-107-826-11	CERAMIC CHIP	0.1μF	10%	16V	C420	1-126-960-11	ELECT	1μF	20%	50V
C344	1-162-970-11	CERAMIC CHIP	0.01μF	10%	25V	C421	1-107-826-11	CERAMIC CHIP	0.1μF	10%	16V
C345	1-113-619-11	CERAMIC CHIP	0.47μF		10V	C422	1-126-768-11	ELECT	2200μF	20%	16V
C346	1-162-970-11	CERAMIC CHIP	0.01μF	10%	25V	C423	1-107-826-11	CERAMIC CHIP	0.1μF	10%	16V
C347	1-162-970-11	CERAMIC CHIP	0.01μF	10%	25V	C424	1-126-964-11	ELECT	10μF	20%	50V
C351	1-162-970-11	CERAMIC CHIP	0.01μF	10%	25V	C426	1-126-964-11	ELECT	10μF	20%	50V
C352	1-126-947-11	ELECT	47μF	20%	35V	C427	1-126-964-11	ELECT	10μF	20%	50V
C353	1-107-826-11	CERAMIC CHIP	0.1μF	10%	16V	C452	1-107-826-11	CERAMIC CHIP	0.1μF	10%	16V
C354	1-162-970-11	CERAMIC CHIP	0.01μF	10%	25V	C453	1-107-826-11	CERAMIC CHIP	0.1μF	10%	16V
C355	1-162-970-11	CERAMIC CHIP	0.01μF	10%	25V	C501	1-102-110-00	CERAMIC	220pF	10%	50V
C356	1-162-970-11	CERAMIC CHIP	0.01μF	10%	25V	C502	1-126-959-11	ELECT	0.47μF	20%	50V
C357	1-126-960-11	ELECT	1μF	20%	50V	C503	1-164-315-11	CERAMIC CHIP	470pF	5%	50V
C358	1-162-970-11	CERAMIC CHIP	0.01μF	10%	25V	C504	1-102-228-00	CERAMIC	470pF	10%	500V



REF. NO.	PART NO.	DESCRIPTION	VALUES			REF. NO.	PART NO.	DESCRIPTION	VALUES		
C505	1-102-228-00	CERAMIC	470pF	10%	500V	C553	1-117-661-11	FILM	0.15μF	5%	250V
C506	1-106-383-00	MYLAR	0.047μF	10%	200V			(KV-32FV310/36FV310 ONLY)			
C507	1-162-116-00	CERAMIC	680pF	10%	2KV	C554	1-117-629-11	FILM	2700pF	3%	1.2KV
C508	1-102-228-00	CERAMIC	470pF	10%	500V			(KV-27FV310/29FV310 ONLY)			
C509	1-162-116-00	CERAMIC	680pF	10%	2KV	C554	1-117-635-11	FILM	4700pF	3%	1.2KV
								(KV-32FV310/36FV310 ONLY)			
C510	1-137-150-11	FILM	0.01μF	5%	100V	C561	1-126-967-11	ELECT	47μF	20%	50V
C511	1-117-652-11	FILM	22000pF	3%	1.2KV	C563	1-104-666-11	ELECT	220μF	20%	25V
		(KV-32FV310/36FV310 ONLY)				C564	1-126-960-11	ELECT	1μF	20%	50V
C511	1-136-086-00	FILM	17000pF		1.2KV	C565	1-126-969-11	ELECT	220μF	20%	50V
		(KV-27FV310/29FV310 ONLY)				C568	1-136-169-00	FILM	0.22μF	5%	50V
C513	1-129-722-00	FILM	0.047μF		630V	C571	1-126-942-61	ELECT	1000μF	20%	25V
		(KV-27FV310/29FV310 ONLY)				C572	1-126-942-61	ELECT	1000μF	20%	25V
C513	1-130-118-91	FILM	0.051μF	5%	400V	C590	1-126-964-11	ELECT	10μF	20%	50V
		(KV-32FV310/36FV310 ONLY)				C1501	1-107-846-11	FILM	0.1μF	5%	400V
C514	1-109-844-11	FILM	0.68μF	5%	400V			(KV-32FV310/36FV310 ONLY)			
		(KV-27FV310/29FV310 ONLY)				C6001	1-126-940-11	ELECT	330μF	20%	25V
C514	1-115-521-11	FILM	0.82μF	5%	250V	C6002	1-126-947-11	ELECT	47μF	20%	35V
		(KV-32FV310/36FV310 ONLY)				C6003	1-125-837-91	CERAMIC CHIP	1μF	10%	6.3V
C515	1-104-987-11	MYLAR	0.001μF	5%	200V	C6005	1-126-768-11	ELECT	2200μF	20%	16V
C516	1-115-356-11	FILM	1.2μF	5%	250V						
		(KV-32FV310/36FV310 ONLY)				<b>CONNECTOR</b>					
C516	1-115-521-11	FILM	0.82μF	5%	250V	* CN003	1-564-509-11	PLUG, CONNECTOR			6P
		(KV-27FV310/29FV310 ONLY)				* CN006	1-564-506-11	PLUG, CONNECTOR			3P
C517	1-107-649-11	ELECT	2.2μF	20%	250V	* CN007	1-560-124-00	PLUG, CONNECTOR (2.5MM)			4P
C518	1-106-387-00	MYLAR	0.068μF	10%	200V	CN306	1-764-611-11	CONNECTOR, BOARD TO BOARD			20P
C519	1-102-244-00	CERAMIC	220pF	10%	500V	* CN333	1-774-105-11	CONNECTOR, BOARD TO BOARD			15P
C520	1-164-646-11	CERAMIC	2200pF	10%	500V	* CN501	1-580-798-11	CONNECTOR PIN (DY)			6P
C522	1-126-960-11	ELECT	1μF	20%	50V	* CN503	1-564-510-11	PLUG, CONNECTOR			7P
C525	1-102-244-00	CERAMIC	220pF	10%	500V	* CN504	1-564-509-11	PLUG, CONNECTOR			6P
C526	1-107-662-11	ELECT	22μF	20%	350V	* CN505	1-564-510-11	PLUG, CONNECTOR			7P
C527	1-162-116-00	CERAMIC	680pF	10%	2KV	* CN590	1-564-507-11	PLUG, CONNECTOR			4P
C528	1-162-966-11	CERAMIC CHIP	0.0022μF	10%	50V	CN600	1-695-915-11	TAB (CONTACT)			
C529	1-128-551-11	ELECT	22μF	20%	63V	* CN3300	1-774-105-11	CONNECTOR, BOARD TO BOARD			15P
C530	1-130-475-00	MYLAR	0.0022μF	5%	50V	* CN3301	1-774-105-11	CONNECTOR, BOARD TO BOARD			15P
C531	1-126-965-91	ELECT	22μF	20%	50V						
C532	1-126-965-91	ELECT	22μF	20%	50V	<b>DIODE</b>					
C534	1-126-967-11	ELECT	47μF	20%	50V	D002	8-719-109-93	DIODE			RD6.2ESB2
C535	1-164-360-11	CERAMIC CHIP	0.1μF		16V	D004	8-719-921-44	DIODE			MTZJ-5.1C
C537	1-126-941-11	ELECT	470μF	20%	25V	D005	8-719-110-17	DIODE			RD10ESB2
C539	1-126-941-11	ELECT	470μF	20%	25V	D006	8-719-110-17	DIODE			RD10ESB2
C540	1-131-867-51	ELECT	100μF		160V	D007	8-719-404-50	DIODE			MA111-TX
C541	1-128-560-11	ELECT	22μF	20%	100V	D008	8-719-404-50	DIODE			MA111-TX
C553	1-117-412-11	FILM	0.24μF	5%	250V	D009	8-719-982-22	DIODE			MTZJ-30D
		(KV-27FV310/29FV310 ONLY)				D010	8-719-109-93	DIODE			RD6.2ESB2



REF. NO.	PART NO.	DESCRIPTION	VALUES	REF. NO.	PART NO.	DESCRIPTION	VALUES
D100	8-719-929-15	DIODE	HZS9.1NB2	D506	8-719-908-03	DIODE	GP08D
D101	8-719-929-15	DIODE	HZS9.1NB2	D507	8-719-991-33	DIODE	1SS133T-77
D102	8-719-109-85	DIODE	RD5.1ESB2	D508	8-719-991-33	DIODE	1SS133T-77
D110	8-719-991-33	DIODE	1SS133T-77	D515	8-719-075-41	DIODE	PR1004GT
D111	8-719-109-93	DIODE	RD6.2ESB2	D516	8-719-991-33	DIODE	1SS133T-77
D112	8-719-109-93	DIODE	RD6.2ESB2	D518	8-719-991-33	DIODE	1SS133T-77
D113	8-719-921-44	DIODE	MTZJ-5.1C	D520	8-719-991-33	DIODE	1SS133T-77
D200	8-719-929-15	DIODE	HZS9.1NB2	D521	8-719-921-63	DIODE	MTZJ-7.5B
D201	8-719-929-15	DIODE	HZS9.1NB2	D522	8-719-991-33	DIODE	1SS133T-77
D209	8-719-929-15	DIODE	HZS9.1NB2	D523	8-719-109-69	DIODE	RD3.6ESB2
D210	8-719-929-15	DIODE	HZS9.1NB2	D524	8-719-109-97	DIODE	RD6.8ESB2
D211	8-719-929-15	DIODE	HZS9.1NB2	D530	6-500-531-01	DIODE	P6154R
D212	8-719-929-15	DIODE	HZS9.1NB2	D531	6-500-531-01	DIODE	P6154R
D213	8-719-929-15	DIODE	HZS9.1NB2	D534	8-719-074-25	DIODE	PG104R
D217	8-719-929-15	DIODE	HZS9.1NB2	D535	8-719-404-50	DIODE	MA111-TX
D218	8-719-929-15	DIODE	HZS9.1NB2	D536	1-216-864-11	SHORT CHIP	
D219	8-719-929-15	DIODE	HZS9.1NB2	D561	8-719-075-33	DIODE	1N4003GA
D302	8-719-981-99	DIODE	MTZJ-3.3	D580	8-719-991-33	DIODE	1SS133T-77
D303	8-719-929-15	DIODE	HZS9.1NB2	D590	8-719-991-33	DIODE	1SS133T-77
D304	8-719-921-44	DIODE	MTZJ-5.1C				
D305	8-719-108-12	DIODE	RD9.1EW			<b>FERRITE BEAD</b>	
D306	8-719-929-15	DIODE	HZS9.1NB2	FB501	1-410-397-21	FERRITE	1.1μH
D307	8-719-929-15	DIODE	HZS9.1NB2	FB502	1-410-397-21	FERRITE	1.1μH
D308	8-719-929-15	DIODE	HZS9.1NB2	FB503	1-410-397-21	FERRITE	1.1μH
D309	8-719-110-17	DIODE	RD10ESB2	FB505	1-410-397-21	FERRITE	1.1μH
D310	8-719-110-17	DIODE	RD10ESB2			<b>IC</b>	
D311	8-719-110-17	DIODE	RD10ESB2	IC001	6-803-010-01	IC	M306V5ME-110SP
D312	8-719-929-15	DIODE	HZS9.1NB2	IC002	6-701-929-01	IC	BD4743G-TR
D313	8-719-108-12	DIODE	RD9.1EW	IC003	8-759-641-86	IC	BR24C16F-E2
D314	8-719-108-12	DIODE	RD9.1EW	IC301	8-752-100-49	IC	CXA2154AS
D315	8-719-110-17	DIODE	RD10ESB2	IC303	8-759-443-11	IC	NJM2283M-TE1
D316	8-719-110-17	DIODE	RD10ESB2	IC400	6-703-190-01	IC	NJW1134AGK1-TE2
D317	8-719-110-17	DIODE	RD10ESB2	IC405	6-701-105-01	IC	NJM2750M-TE2
D320	8-719-991-33	DIODE	1SS133T-77	IC501	8-759-700-07	IC	NJM2903M
D401	8-719-923-60	DIODE	MTZJ-T-77-9.1A	IC561	8-759-696-71	IC	STV9379A
D402	8-719-923-60	DIODE	MTZJ-T-77-9.1A			(KV-32FV310/36FV310 ONLY)	
D412	8-719-404-50	DIODE	MA111-TX	IC561	8-759-980-58	IC	TDA8172
D413	8-719-921-63	DIODE	MTZJ-7.5B			(KV-27FV310/29FV310 ONLY)	
D415	8-719-991-33	DIODE	1SS133T-77	IC6008	6-701-752-01	IC	NJM2930F05B
D501	8-719-109-89	DIODE	RD5.6ESB2			<b>JACK</b>	
D502	8-719-081-00	DIODE	BY228/A52A/	J201	1-794-119-11	TERMINAL BLOCK, S	4P
D503	8-719-081-00	DIODE	BY228/A52A/	J203	1-794-118-11	JACK BLOCK, PIN	3P
D504	6-500-485-01	DIODE	FR305G-EB	J204	1-794-118-11	JACK BLOCK, PIN	3P
D505	8-719-908-03	DIODE	GP08D				







REF. NO.	PART NO.	DESCRIPTION	VALUES			REF. NO.	PART NO.	DESCRIPTION	VALUES		
Q315	8-729-424-02	TRANSISTOR	2SB709A-QRS-TX			R020	1-218-688-11	METAL CHIP	680	0.50%	1/10W
Q316	8-729-424-02	TRANSISTOR	2SB709A-QRS-TX			R021	1-216-829-11	METAL CHIP	4.7K	5%	1/10W
Q317	8-729-422-27	TRANSISTOR	2SD601A-Q			R022	1-218-688-11	METAL CHIP	680	0.50%	1/10W
Q319	8-729-422-27	TRANSISTOR	2SD601A-Q			R023	1-216-829-11	METAL CHIP	4.7K	5%	1/10W
Q325	8-729-422-27	TRANSISTOR	2SD601A-Q			R024	1-218-688-11	METAL CHIP	680	0.50%	1/10W
Q326	8-729-424-02	TRANSISTOR	2SB709A-QRS-TX			R025	1-216-813-11	METAL CHIP	220	5%	1/10W
Q400	8-729-422-27	TRANSISTOR	2SD601A-Q			R027	1-216-813-11	METAL CHIP	220	5%	1/10W
Q401	8-729-422-27	TRANSISTOR	2SD601A-Q			R029	1-249-409-11	CARBON	220	5%	1/4W
Q402	8-729-422-27	TRANSISTOR	2SD601A-Q			R030	1-216-841-11	METAL CHIP	47K	5%	1/10W
Q403	8-729-422-27	TRANSISTOR	2SD601A-Q			R031	1-216-809-11	METAL CHIP	100	5%	1/10W
Q407	8-729-422-27	TRANSISTOR	2SD601A-Q			R032	1-216-813-11	METAL CHIP	220	5%	1/10W
Q500	8-729-422-27	TRANSISTOR	2SD601A-Q			R033	1-249-417-11	CARBON	1K	5%	1/4W
Q501	8-729-140-50	TRANSISTOR	2SC3209LK			R034	1-216-813-11	METAL CHIP	220	5%	1/10W
Q502	6-550-107-01	TRANSISTOR	2SD2645-YB			R035	1-216-813-11	METAL CHIP	220	5%	1/10W
Q511	8-729-120-28	TRANSISTOR	2SC1623-L5L6			R037	1-216-829-11	METAL CHIP	4.7K	5%	1/10W
Q512	8-729-809-29	TRANSISTOR	2SC4159-E			R038	1-249-417-11	CARBON	1K	5%	1/4W
Q530	8-729-422-27	TRANSISTOR	2SD601A-Q			R039	1-216-829-11	METAL CHIP	4.7K	5%	1/10W
Q531	8-729-424-02	TRANSISTOR	2SB709A-QRS-TX			R048	1-216-829-11	METAL CHIP	4.7K	5%	1/10W
Q532	6-550-362-01	TRANSISTOR	KTA1279			R050	1-216-833-11	METAL CHIP	10K	5%	1/10W
Q561	8-729-422-27	TRANSISTOR	2SD601A-Q			R051	1-216-857-11	METAL CHIP	1M	5%	1/10W
Q562	8-729-120-28	TRANSISTOR	2SC1623-L5L6			R052	1-216-845-11	METAL CHIP	100K	5%	1/10W
Q580	8-729-424-02	TRANSISTOR	2SB709A-QRS-TX			R053	1-216-821-11	METAL CHIP	1K	5%	1/10W
Q581	8-729-424-02	TRANSISTOR	2SB709A-QRS-TX			R054	1-249-417-11	CARBON	1K	5%	1/4W
Q590	8-729-422-27	TRANSISTOR	2SD601A-Q			R055	1-216-841-11	METAL CHIP	47K	5%	1/10W
Q6000	8-729-422-27	TRANSISTOR	2SD601A-Q			R056	1-216-813-11	METAL CHIP	220	5%	1/10W
<b>RESISTOR</b>						R057	1-216-845-11	METAL CHIP	100K	5%	1/10W
R001	1-249-429-11	CARBON	10K	5%	1/4W	R058	1-216-845-11	METAL CHIP	100K	5%	1/10W
R002	1-249-409-11	CARBON	220	5%	1/4W	R060	1-249-409-11	CARBON	220	5%	1/4W
R003	1-216-817-11	METAL CHIP	470	5%	1/10W	R061	1-249-437-11	CARBON	47K	5%	1/4W
R004	1-216-857-11	METAL CHIP	1M	5%	1/10W	R063	1-216-829-11	METAL CHIP	4.7K	5%	1/10W
R005	1-216-821-11	METAL CHIP	1K	5%	1/10W	R064	1-216-813-11	METAL CHIP	220	5%	1/10W
R006	1-249-417-11	CARBON	1K	5%	1/4W	R065	1-216-841-11	METAL CHIP	47K	5%	1/10W
R007	1-216-833-11	METAL CHIP	10K	5%	1/10W	R066	1-249-429-11	CARBON	10K	5%	1/4W
R009	1-216-864-11	SHORT CHIP				R070	1-216-813-11	METAL CHIP	220	5%	1/10W
R010	1-249-409-11	CARBON	220	5%	1/4W	R071	1-216-841-11	METAL CHIP	47K	5%	1/10W
R011	1-216-821-11	METAL CHIP	1K	5%	1/10W	R073	1-249-425-11	CARBON	4.7K	5%	1/4W
R012	1-216-827-11	METAL CHIP	3.3K	5%	1/10W	R074	1-249-417-11	CARBON	1K	5%	1/4W
R013	1-218-867-11	METAL CHIP	6.8K	0.50%	1/10W	R075	1-216-813-11	METAL CHIP	220	5%	1/10W
R015	1-216-813-11	METAL CHIP	220	5%	1/10W	R076	1-216-841-11	METAL CHIP	47K	5%	1/10W
R016	1-216-813-11	METAL CHIP	220	5%	1/10W	R077	1-216-809-11	METAL CHIP	100	5%	1/10W
R017	1-216-813-11	METAL CHIP	220	5%	1/10W	R078	1-216-841-11	METAL CHIP	47K	5%	1/10W
R018	1-216-813-11	METAL CHIP	220	5%	1/10W	R080	1-216-829-11	METAL CHIP	4.7K	5%	1/10W
R019	1-216-829-11	METAL CHIP	4.7K	5%	1/10W	R085	1-215-924-00	METAL OXIDE	15K	5%	3W
						R086	1-216-839-11	METAL CHIP	33K	5%	1/10W





REF. NO.	PART NO.	DESCRIPTION	VALUES			REF. NO.	PART NO.	DESCRIPTION	VALUES		
R087	1-216-837-11	METAL CHIP	22K	5%	1/10W	R224	1-216-813-11	METAL CHIP	220	5%	1/10W
R089	1-216-829-11	METAL CHIP	4.7K	5%	1/10W	R225	1-216-845-11	METAL CHIP	100K	5%	1/10W
R098	1-216-821-11	METAL CHIP	1K	5%	1/10W	R228	1-216-845-11	METAL CHIP	100K	5%	1/10W
R099	1-216-809-11	METAL CHIP	100	5%	1/10W	R229	1-216-845-11	METAL CHIP	100K	5%	1/10W
R101	1-216-829-11	METAL CHIP	4.7K	5%	1/10W	R230	1-249-409-11	CARBON	220	5%	1/4W
R102	1-216-829-11	METAL CHIP	4.7K	5%	1/10W	R231	1-216-813-11	METAL CHIP	220	5%	1/10W
R103	1-249-425-11	CARBON	4.7K	5%	1/4W	R232	1-216-853-11	METAL CHIP	470K	5%	1/10W
R104	1-216-813-11	METAL CHIP	220	5%	1/10W	R233	1-216-853-11	METAL CHIP	470K	5%	1/10W
R107	1-216-809-11	METAL CHIP	100	5%	1/10W	R234	1-216-813-11	METAL CHIP	220	5%	1/10W
R108	1-216-809-11	METAL CHIP	100	5%	1/10W	R235	1-216-813-11	METAL CHIP	220	5%	1/10W
R110	1-247-807-31	CARBON	100	5%	1/4W	R300	1-113-619-11	CERAMIC CHIP	0.47 $\mu$ F		10V
R111	1-216-809-11	METAL CHIP	100	5%	1/10W	R301	1-216-809-11	METAL CHIP	100	5%	1/10W
R113	1-247-807-31	CARBON	100	5%	1/4W	R302	1-216-817-11	METAL CHIP	470	5%	1/10W
R114	1-249-409-11	CARBON	220	5%	1/4W	R303	1-216-818-11	METAL CHIP	560	5%	1/10W
R117	1-216-837-11	METAL CHIP	22K	5%	1/10W	R306	1-216-843-11	METAL CHIP	68K	5%	1/10W
R118	1-216-837-11	METAL CHIP	22K	5%	1/10W	R307	1-216-843-11	METAL CHIP	68K	5%	1/10W
R120	1-249-413-11	CARBON	470	5%	1/4W	R308	1-216-833-11	METAL CHIP	10K	5%	1/10W
R125	1-216-813-11	METAL CHIP	220	5%	1/10W	R309	1-216-864-11	SHORT CHIP			
R129	1-249-409-11	CARBON	220	5%	1/4W	R315	1-218-285-11	METAL CHIP	75	5%	1/10W
R130	1-216-829-11	METAL CHIP	4.7K	5%	1/10W	R316	1-218-285-11	METAL CHIP	75	5%	1/10W
R131	1-216-813-11	METAL CHIP	220	5%	1/10W	R317	1-218-285-11	METAL CHIP	75	5%	1/10W
R132	1-216-829-11	METAL CHIP	4.7K	5%	1/10W	R320	1-216-864-11	SHORT CHIP			
R133	1-216-841-11	METAL CHIP	47K	5%	1/10W	R322	1-216-829-11	METAL CHIP	4.7K	5%	1/10W
R134	1-216-813-11	METAL CHIP	220	5%	1/10W	R325	1-247-807-31	CARBON	100	5%	1/4W
R135	1-216-813-11	METAL CHIP	220	5%	1/10W	R328	1-216-833-11	METAL CHIP	10K	5%	1/10W
R136	1-249-425-11	CARBON	4.7K	5%	1/4W	R329	1-216-809-11	METAL CHIP	100	5%	1/10W
R137	1-216-829-11	METAL CHIP	4.7K	5%	1/10W	R331	1-218-716-11	METAL CHIP	10K	0.50%	1/10W
R139	1-216-813-11	METAL CHIP	220	5%	1/10W	R332	1-216-809-11	METAL CHIP	100	5%	1/10W
R140	1-249-409-11	CARBON	220	5%	1/4W	R333	1-216-809-11	METAL CHIP	100	5%	1/10W
R145	1-249-401-11	CARBON	47	5%	1/4W	R334	1-216-821-11	METAL CHIP	1K	5%	1/10W
R201	1-216-864-11	SHORT CHIP				R335	1-216-821-11	METAL CHIP	1K	5%	1/10W
R202	1-249-409-11	CARBON	220	5%	1/4W	R336	1-216-809-11	METAL CHIP	100	5%	1/10W
R203	1-216-809-11	METAL CHIP	100	5%	1/10W	R337	1-249-417-11	CARBON	1K	5%	1/4W
R206	1-249-409-11	CARBON	220	5%	1/4W	R338	1-247-807-31	CARBON	100	5%	1/4W
R207	1-216-845-11	METAL CHIP	100K	5%	1/10W	R347	1-216-825-11	METAL CHIP	2.2K	5%	1/10W
R208	1-249-409-11	CARBON	220	5%	1/4W	R348	1-216-825-11	METAL CHIP	2.2K	5%	1/10W
R209	1-216-845-11	METAL CHIP	100K	5%	1/10W	R349	1-216-864-11	SHORT CHIP			
R210	1-249-409-11	CARBON	220	5%	1/4W	R350	1-216-825-11	METAL CHIP	2.2K	5%	1/10W
R217	1-216-845-11	METAL CHIP	100K	5%	1/10W	R351	1-216-864-11	SHORT CHIP			
R218	1-216-845-11	METAL CHIP	100K	5%	1/10W	R352	1-216-864-11	SHORT CHIP			
R219	1-216-813-11	METAL CHIP	220	5%	1/10W	R353	1-249-427-11	CARBON	6.8K	5%	1/4W
R220	1-216-813-11	METAL CHIP	220	5%	1/10W	R354	1-216-829-11	METAL CHIP	4.7K	5%	1/10W
R222	1-216-845-11	METAL CHIP	100K	5%	1/10W	R355	1-216-864-11	SHORT CHIP			
R223	1-216-813-11	METAL CHIP	220	5%	1/10W	R359	1-216-833-11	METAL CHIP	10K	5%	1/10W



REF. NO.	PART NO.	DESCRIPTION	VALUES			REF. NO.	PART NO.	DESCRIPTION	VALUES		
R368	1-216-864-11	SHORT CHIP				R501	1-216-815-11	METAL CHIP	330	5%	1/10W
R369	1-216-809-11	METAL CHIP	100	5%	1/10W			(KV-27FV310/29FV310 ONLY)			
R370	1-216-809-11	METAL CHIP	100	5%	1/10W	R501	1-216-817-11	METAL CHIP	470	5%	1/10W
R372	1-216-864-11	SHORT CHIP						(KV-32FV310/36FV310 ONLY)			
R374	1-216-833-11	METAL CHIP	10K	5%	1/10W	R502	1-216-829-11	METAL CHIP	4.7K	5%	1/10W
R376	1-216-809-11	METAL CHIP	100	5%	1/10W	R503	1-249-425-11	CARBON	4.7K	5%	1/4W
R378	1-216-809-11	METAL CHIP	100	5%	1/10W	R504	1-215-892-11	METAL OXIDE	1K	5%	2W
R379	1-216-809-11	METAL CHIP	100	5%	1/10W			(KV-27FV310/29FV310 ONLY)			
R380	1-216-809-11	METAL CHIP	100	5%	1/10W	R504	1-216-455-11	METAL OXIDE	560	5%	2W
R381	1-216-864-11	SHORT CHIP						(KV-32FV310/36FV310 ONLY)			
R382	1-218-867-11	METAL CHIP	6.8K	0.50%	1/10W	R505	1-249-433-11	CARBON	22K	5%	1/4W
R384	1-216-840-11	METAL CHIP	39K	5%	1/10W	R506	1-215-861-00	METAL OXIDE	47	5%	1W
R385	1-216-813-11	METAL CHIP	220	5%	1/10W	R507	1-249-401-11	CARBON	47	5%	1/4W
R387	1-216-864-11	SHORT CHIP				R508	1-249-425-11	CARBON	4.7K	5%	1/4W
R388	1-216-821-11	METAL CHIP	1K	5%	1/10W	R509	1-260-328-11	CARBON	1K	5%	1/2W
R389	1-216-864-11	SHORT CHIP				R510	1-215-908-00	METAL OXIDE	33	5%	3W
R390	1-218-285-11	METAL CHIP	75	5%	1/10W	R512	1-215-910-00	METAL OXIDE	68	5%	3W
R391	1-218-285-11	METAL CHIP	75	5%	1/10W	R516	1-216-828-11	METAL CHIP	3.9K	5%	1/10W
R393	1-218-285-11	METAL CHIP	75	5%	1/10W			(KV-32FV310 ONLY)			
R394	1-218-285-11	METAL CHIP	75	5%	1/10W	R516	1-216-829-11	METAL CHIP	4.7K	5%	1/10W
R395	1-218-285-11	METAL CHIP	75	5%	1/10W			(KV-36FV310 ONLY)			
R396	1-216-853-11	METAL CHIP	470K	5%	1/10W	R516	1-216-832-11	METAL CHIP	8.2K	5%	1/10W
R397	1-216-821-11	METAL CHIP	1K	5%	1/10W			(KV-27FV310/29FV310 ONLY)			
R398	1-216-841-11	METAL CHIP	47K	5%	1/10W	R517	1-249-417-11	CARBON	1K	5%	1/4W
R399	1-216-845-11	METAL CHIP	100K	5%	1/10W	R518	1-216-833-11	METAL CHIP	10K	5%	1/10W
R400	1-216-829-11	METAL CHIP	4.7K	5%	1/10W	R519	1-249-413-11	CARBON	470	5%	1/4W
R401	1-247-807-31	CARBON	100	5%	1/4W	R520	1-215-907-11	METAL OXIDE	22	5%	3W
R402	1-216-845-11	METAL CHIP	100K	5%	1/10W	R523	1-216-834-11	METAL CHIP	12K	5%	1/10W
R403	1-247-807-31	CARBON	100	5%	1/4W			(KV-32FV310/36FV310 ONLY)			
R404	1-216-845-11	METAL CHIP	100K	5%	1/10W	R523	1-216-837-11	METAL CHIP	22K	5%	1/10W
R405	1-216-825-11	METAL CHIP	2.2K	5%	1/10W			(KV-27FV310/29FV310 ONLY)			
R406	1-216-825-11	METAL CHIP	2.2K	5%	1/10W	R524	1-249-429-11	CARBON	10K	5%	1/4W
R407	1-216-825-11	METAL CHIP	2.2K	5%	1/10W	R525	1-249-428-11	CARBON	8.2K	5%	1/4W
R408	1-216-825-11	METAL CHIP	2.2K	5%	1/10W	R526	1-215-905-11	METAL OXIDE	10	5%	3W
R409	1-247-807-31	CARBON	100	5%	1/4W			(KV-32FV310/36FV310 ONLY)			
R410	1-216-813-11	METAL CHIP	220	5%	1/10W	R526	1-216-377-11	METAL OXIDE	4.7	5%	2W
R411	1-216-817-11	METAL CHIP	470	5%	1/10W			(KV-27FV310/29FV310 ONLY)			
R412	1-216-821-11	METAL CHIP	1K	5%	1/10W	R528	1-216-837-11	METAL CHIP	22K	5%	1/10W
R413	1-216-833-11	METAL CHIP	10K	5%	1/10W	R529	1-218-724-11	METAL CHIP	22K	0.50%	1/10W
R414	1-216-813-11	METAL CHIP	220	5%	1/10W	R530	1-218-718-11	METAL CHIP	12K	0.50%	1/10W
R416	1-216-829-11	METAL CHIP	4.7K	5%	1/10W	R531	1-218-734-11	METAL CHIP	56K	0.50%	1/10W
R452	1-216-813-11	METAL CHIP	220	5%	1/10W			(KV-32FV310/36FV310 ONLY)			
R453	1-216-813-11	METAL CHIP	220	5%	1/10W	R531	1-218-746-11	METAL CHIP	180K	0.50%	1/10W
R500	1-249-409-11	CARBON	220	5%	1/4W			(KV-27FV310/29FV310 ONLY)			



REF. NO.	PART NO.	DESCRIPTION	VALUES			REF. NO.	PART NO.	DESCRIPTION	VALUES		
R532	1-216-810-11	METAL CHIP	120	5%	1/10W	R586	1-216-825-11	METAL CHIP	2.2K	5%	1/10W
R533	1-215-879-11	METAL OXIDE	47K	5%	1W	R587	1-216-809-11	METAL CHIP	100	5%	1/10W
R534	1-218-720-11	METAL CHIP	15K	0.50%	1/10W	R588	1-216-821-11	METAL CHIP	1K	5%	1/10W
		(KV-36FV310 ONLY)				R590	1-216-809-11	METAL CHIP	100	5%	1/10W
R536	1-260-288-11	CARBON	0.47	5%	1/2W	R591	1-249-417-11	CARBON	1K	5%	1/4W
R537	1-260-288-11	CARBON	0.47	5%	1/2W	R592	1-216-363-00	METAL OXIDE	0.33	5%	2W
R538	1-247-887-00	CARBON	220K	5%	1/4W	R593	1-249-417-11	CARBON	1K	5%	1/4W
R545	1-249-387-11	CARBON	3.3	5%	1/4W			(KV-27FV310/29FV310 ONLY)			
R553	1-249-377-11	CARBON	0.47	5%	1/4W	R593	1-249-420-11	CARBON	1.8K	5%	1/4W
R558	1-218-720-11	METAL CHIP	15K	0.50%	1/10W			(KV-32FV310/36FV310 ONLY)			
		(KV-36FV310 ONLY)				R594	1-249-429-11	CARBON	10K	5%	1/4W
R559	1-216-805-11	METAL CHIP	47	5%	1/10W	R595	1-247-891-00	CARBON	330K	5%	1/4W
R561	1-215-445-00	METAL	10K	1%	1/4W	R596	1-249-441-11	CARBON	100K	5%	1/4W
R563	1-214-798-21	METAL	1.8	1%	1/2W	R597	1-216-864-11	SHORT CHIP			
R564	1-247-895-91	CARBON	470K	5%	1/4W	R598	1-218-867-11	METAL CHIP	6.8K	0.50%	1/10W
R565	1-215-889-00	METAL OXIDE	330	5%	2W	R599	1-216-825-11	METAL CHIP	2.2K	5%	1/10W
R566	1-218-710-11	METAL CHIP	5.6K	0.50%	1/10W	R900	1-216-821-11	METAL CHIP	1K	5%	1/10W
		(KV-32FV310 ONLY)				R901	1-216-809-11	METAL CHIP	100	5%	1/10W
R566	1-218-712-11	METAL CHIP	6.8K	0.50%	1/10W	R902	1-216-809-11	METAL CHIP	100	5%	1/10W
		(KV-27FV310/29FV310 ONLY)				R903	1-216-825-11	METAL CHIP	2.2K	5%	1/10W
R566	1-218-716-11	METAL CHIP	10K	0.50%	1/10W	R904	1-216-818-11	METAL CHIP	560	5%	1/10W
		(KV-36FV310 ONLY)				R905	1-216-817-11	METAL CHIP	470	5%	1/10W
R567	1-249-385-11	CARBON	2.2	5%	1/4W	R906	1-216-821-11	METAL CHIP	1K	5%	1/10W
R568	1-218-710-11	METAL CHIP	5.6K	0.50%	1/10W	R907	1-216-833-11	METAL CHIP	10K	5%	1/10W
		(KV-32FV310 ONLY)				R908	1-216-829-11	METAL CHIP	4.7K	5%	1/10W
R568	1-218-712-11	METAL CHIP	6.8K	0.50%	1/10W	R909	1-249-417-11	CARBON	1K	5%	1/4W
		(KV-27FV310/29FV310 ONLY)				R910	1-216-833-11	METAL CHIP	10K	5%	1/10W
R568	1-218-716-11	METAL CHIP	10K	0.50%	1/10W	R912	1-249-417-11	CARBON	1K	5%	1/4W
		(KV-36FV310 ONLY)				R932	1-218-285-11	METAL CHIP	75	5%	1/10W
R569	1-215-445-00	METAL	10K	1%	1/4W	R934	1-218-285-11	METAL CHIP	75	5%	1/10W
R570	1-216-845-11	METAL CHIP	100K	5%	1/10W	R940	1-247-807-31	CARBON	100	5%	1/4W
R571	1-216-837-11	METAL CHIP	22K	5%	1/10W	R941	1-247-807-31	CARBON	100	5%	1/4W
R572	1-216-837-11	METAL CHIP	22K	5%	1/10W	R942	1-216-841-11	METAL CHIP	47K	5%	1/10W
R573	1-216-845-11	METAL CHIP	100K	5%	1/10W	R947	1-216-864-11	SHORT CHIP			
R574	1-214-798-21	METAL	1.8	1%	1/2W	R950	1-216-809-11	METAL CHIP	100	5%	1/10W
R576	1-215-905-11	METAL OXIDE	10	5%	3W	R951	1-216-813-11	METAL CHIP	220	5%	1/10W
		(KV-32FV310/36FV310 ONLY)				R953	1-218-285-11	METAL CHIP	75	5%	1/10W
R576	1-215-907-11	METAL OXIDE	22	5%	3W	R6001	1-216-833-11	METAL CHIP	10K	5%	1/10W
		(KV-27FV310/29FV310 ONLY)				R6002	1-216-833-11	METAL CHIP	10K	5%	1/10W
R577	1-216-821-11	METAL CHIP	1K	5%	1/10W	R6003	1-216-833-11	METAL CHIP	10K	5%	1/10W
R578	1-214-798-21	METAL	1.8	1%	1/2W	R6004	1-249-417-11	CARBON	1K	5%	1/4W
R583	1-216-833-11	METAL CHIP	10K	5%	1/10W			<b>SWITCH</b>			
R584	1-216-829-11	METAL CHIP	4.7K	5%	1/10W	S501	1-572-707-11	SWITCH, LEVER			
R585	1-216-821-11	METAL CHIP	1K	5%	1/10W	S502	1-572-707-11	SWITCH, LEVER			



REF. NO.	PART NO.	DESCRIPTION	VALUES	REF. NO.	PART NO.	DESCRIPTION	VALUES
<b><u>TRANSFORMER</u></b>							
T501	1-433-836-11	TRANSFORMER, HORIZONTAL DRIVE					
T502	1-435-869-11	TRANSFORMER, FERRITE (PMT)					
T505	1-433-850-11	TRANSFORMER, HORIZONTAL LINEAR (KV-27FV310/29FV310 ONLY)					
T505	1-435-098-21	TRANSFORMER, HORIZONTAL LINEAR (KV-32FV310/36FV310 ONLY)					
T510	1-439-767-11	HORIZONTAL OUTPUT TRANSFORMER (KV-27FV310/29FV310 ONLY)					
T510	1-439-848-11	HORIZONTAL OUTPUT TRANSFORMER (KV-32FV310/36FV310 ONLY)					
<b><u>THERMISTOR</u></b>							
TH501	1-800-193-00	THERMISTOR					
<b><u>TUNER</u></b>							
TU001	8-598-593-50	TUNER, FSS BTF-WA421					
<b><u>CRYSTAL</u></b>							
X001	1-795-572-11	VIBRATOR, CRYSTAL					
X301	1-567-505-11	OSCILLATOR, CRYSTAL					
<b><u>HR</u></b>							
*	<b>A-1400-251-A</b>	<b>HR (COM) BOARD, MOUNTED</b>					
<b><u>CAPACITOR</u></b>							
C3001	1-104-665-11	ELECT	100μF 20% 25V				
<b><u>CONNECTOR</u></b>							
* CN3001	1-564-521-11	PLUG, CONNECTOR	6P				
<b><u>DIODE</u></b>							
D3002	8-719-057-09	DIODE	LNJ801LPDJA				
<b><u>IC</u></b>							
IC3001	8-742-211-20	HYB IC	SBX3071-71				
<b><u>RESISTOR</u></b>							
R3001	1-249-417-11	CARBON	1K 5% 1/4W				
R3014	1-247-807-31	CARBON	100 5% 1/4W				
<b><u>SWITCH</u></b>							
S3006	1-786-338-11	SWITCH, TACTILE					
				<b><u>BC</u></b>			
				* <b>A-1400-450-A BC BOARD, MOUNTED</b>			
				<b><u>CAPACITOR</u></b>			
				C3355	1-162-964-11	CERAMIC CHIP	0.001μF 10% 50V
				C3356	1-126-964-11	ELECT	10μF 20% 50V
				C3357	1-113-619-11	CERAMIC CHIP	0.47μF 10V
				C3358	1-126-940-11	ELECT	330μF 20% 25V
				C3359	1-107-826-11	CERAMIC CHIP	0.1μF 10% 16V
				C3360	1-162-970-11	CERAMIC CHIP	0.01μF 10% 25V
				C3361	1-162-922-11	CERAMIC CHIP	39pF 5% 50V
				C3369	1-126-967-11	ELECT	47μF 20% 50V
				C3370	1-126-964-11	ELECT	10μF 20% 50V
				C3371	1-107-826-11	CERAMIC CHIP	0.1μF 10% 16V
				C3398	1-126-961-11	ELECT	2.2μF 20% 50V
				C3504	1-162-920-11	CERAMIC CHIP	27pF 5% 50V
				C3505	1-162-920-11	CERAMIC CHIP	27pF 5% 50V
				C3506	1-164-360-11	CERAMIC CHIP	0.1μF 16V
				C3507	1-164-360-11	CERAMIC CHIP	0.1μF 16V
				C3509	1-164-360-11	CERAMIC CHIP	0.1μF 16V
				C3510	1-164-392-11	CERAMIC CHIP	390pF 5% 50V
				C3511	1-164-360-11	CERAMIC CHIP	0.1μF 16V
				C3512	1-164-360-11	CERAMIC CHIP	0.1μF 16V
				C3513	1-216-864-11	SHORT CHIP	
				C3514	1-162-974-11	CERAMIC CHIP	0.01μF 50V
				C3515	1-164-360-11	CERAMIC CHIP	0.1μF 16V
				C3516	1-164-360-11	CERAMIC CHIP	0.1μF 16V
				C3517	1-126-924-11	ELECT	330μF 20% 10V
				C3518	1-164-360-11	CERAMIC CHIP	0.1μF 16V
				C3519	1-164-360-11	CERAMIC CHIP	0.1μF 16V
				C3520	1-164-360-11	CERAMIC CHIP	0.1μF 16V
				C3521	1-162-920-11	CERAMIC CHIP	27pF 5% 50V
				C3522	1-126-947-11	ELECT	47μF 20% 35V
				C3523	1-164-360-11	CERAMIC CHIP	0.1μF 16V
				C3524	1-164-360-11	CERAMIC CHIP	0.1μF 16V
				C3525	1-164-360-11	CERAMIC CHIP	0.1μF 16V
				C3526	1-164-360-11	CERAMIC CHIP	0.1μF 16V
				C3527	1-164-360-11	CERAMIC CHIP	0.1μF 16V
				C3528	1-164-360-11	CERAMIC CHIP	0.1μF 16V
				C3529	1-164-360-11	CERAMIC CHIP	0.1μF 16V
				C3530	1-126-947-11	ELECT	47μF 20% 35V
				C3531	1-164-360-11	CERAMIC CHIP	0.1μF 16V
				C3532	1-126-964-11	ELECT	10μF 20% 50V



REF. NO.	PART NO.	DESCRIPTION	VALUES			REF. NO.	PART NO.	DESCRIPTION	VALUES
C3533	1-164-315-11	CERAMIC CHIP	470pF	5%	50V	<b><u>FERRITE BEAD</u></b>			
C3534	1-109-889-11	ELECT	1μF	20%	50V	FB3502	1-414-234-22	FERRITE	0μH
C3535	1-162-917-11	CERAMIC CHIP	15pF	5%	50V	FB3503	1-414-234-22	FERRITE	0μH
C3536	1-126-960-11	ELECT	1μF	20%	50V	FB3504	1-414-234-22	FERRITE	0μH
C3537	1-164-360-11	CERAMIC CHIP	0.1μF		16V	FB3505	1-414-234-22	FERRITE	0μH
C3538	1-162-917-11	CERAMIC CHIP	15pF	5%	50V	FB3506	1-414-234-22	FERRITE	0μH
C3539	1-162-917-11	CERAMIC CHIP	15pF	5%	50V	FB3507	1-414-234-22	FERRITE	0μH
C3541	1-162-918-11	CERAMIC CHIP	18pF	5%	50V	FB3508	1-414-234-22	FERRITE	0μH
C3542	1-126-964-11	ELECT	10μF	20%	50V	FB3509	1-414-234-22	FERRITE	0μH
C3543	1-135-834-91	CERAMIC CHIP	2.2μF		6.3V	<b><u>FILTER</u></b>			
C3546	1-162-917-11	CERAMIC CHIP	15pF	5%	50V	FL3500	1-239-848-21	FILTER, LOW PASS	
C3547	1-126-934-11	ELECT	220μF	20%	16V	FL3501	1-239-848-21	FILTER, LOW PASS	
C3548	1-107-826-11	CERAMIC CHIP	0.1μF	10%	16V	FL3502	1-239-848-21	FILTER, LOW PASS	
C3549	1-126-947-11	ELECT	47μF	20%	35V	FL3503	1-239-848-21	FILTER, LOW PASS	
C3550	1-162-974-11	CERAMIC CHIP	0.01μF		50V	FL3504	1-233-736-21	FILTER, EMI	
C3551	1-126-947-11	ELECT	47μF	20%	35V	FL3505	1-233-736-21	FILTER, EMI	
C3552	1-162-974-11	CERAMIC CHIP	0.01μF		50V	FL3506	1-233-736-21	FILTER, EMI	
C3553	1-162-974-11	CERAMIC CHIP	0.01μF		50V	<b><u>IC</u></b>			
C3554	1-126-960-11	ELECT	1μF	20%	50V	IC3501	6-700-960-01	IC	UPD64083GF-3BA
C3555	1-126-934-11	ELECT	220μF	20%	16V	IC3502	8-759-462-91	IC	TA1226N
C3556	1-107-826-11	CERAMIC CHIP	0.1μF	10%	16V	IC3503	8-759-583-47	IC	UPC2933T-E2
C3557	1-162-974-11	CERAMIC CHIP	0.01μF		50V	IC3504	6-700-394-01	IC	BA25BC0FP-E2
C3558	1-126-947-11	ELECT	47μF	20%	35V	IC3505	8-759-394-35	IC	BA12T
C3559	1-162-974-11	CERAMIC CHIP	0.01μF		50V	<b><u>CHIP CONDUCTOR</u></b>			
C3560	1-126-947-11	ELECT	47μF	20%	35V	JR3301	1-216-864-11	SHORT CHIP	
C3561	1-162-974-11	CERAMIC CHIP	0.01μF		50V	JR3302	1-216-864-11	SHORT CHIP	
C3562	1-162-974-11	CERAMIC CHIP	0.01μF		50V	JR3501	1-216-864-11	SHORT CHIP	
C3563	1-126-947-11	ELECT	47μF	20%	35V	<b><u>COIL</u></b>			
C3564	1-126-947-11	ELECT	47μF	20%	35V	L3352	1-414-186-31	INDUCTOR	33μH
C3565	1-162-974-11	CERAMIC CHIP	0.01μF		50V	L3500	1-414-265-21	INDUCTOR	4.7μH
C3566	1-162-974-11	CERAMIC CHIP	0.01μF		50V	L3501	1-414-267-21	INDUCTOR	10μH
C3580	1-126-940-11	ELECT	330μF	20%	25V	L3502	1-414-267-21	INDUCTOR	10μH
C3581	1-107-826-11	CERAMIC CHIP	0.1μF	10%	16V	L3503	1-414-267-21	INDUCTOR	10μH
C3582	1-126-934-11	ELECT	220μF	20%	16V	L3504	1-414-267-21	INDUCTOR	10μH
C3583	1-126-934-11	ELECT	220μF	20%	16V	L3505	1-414-267-21	INDUCTOR	10μH
C3585	1-107-826-11	CERAMIC CHIP	0.1μF	10%	16V	<b><u>TRANSISTOR</u></b>			
C3590	1-104-665-11	ELECT	100μF	20%	25V	Q3301	8-729-422-27	TRANSISTOR	2SD601A-Q
<b><u>CONNECTOR</u></b>						Q3500	8-729-424-02	TRANSISTOR	2SB709A-QRS-TX
CN3500	1-764-613-11	CONNECTOR, BOARD TO BOARD	20P			Q3501	8-729-422-27	TRANSISTOR	2SD601A-Q
<b><u>DIODE</u></b>						Q3502	8-729-424-02	TRANSISTOR	2SB709A-QRS-TX
D3550	8-719-977-28	DIODE	DTZ10B						



REF. NO.	PART NO.	DESCRIPTION	VALUES			REF. NO.	PART NO.	DESCRIPTION	VALUES		
Q3503	8-729-422-27	TRANSISTOR	2SD601A-Q			R3523	1-216-821-11	METAL CHIP	1K	5%	1/10W
Q3504	8-729-424-02	TRANSISTOR	2SB709A-QRS-TX			R3524	1-216-841-11	METAL CHIP	47K	5%	1/10W
Q3505	8-729-422-27	TRANSISTOR	2SD601A-Q			R3525	1-216-825-11	METAL CHIP	2.2K	5%	1/10W
Q3506	8-729-422-27	TRANSISTOR	2SD601A-Q			R3526	1-216-849-11	METAL CHIP	220K	5%	1/10W
Q3508	8-729-422-27	TRANSISTOR	2SD601A-Q			R3527	1-218-676-11	METAL CHIP	220	0.50%	1/10W
Q3509	8-729-424-02	TRANSISTOR	2SB709A-QRS-TX			R3528	1-216-818-11	METAL CHIP	560	5%	1/10W
Q3510	8-729-424-02	TRANSISTOR	2SB709A-QRS-TX			R3529	1-216-818-11	METAL CHIP	560	5%	1/10W
Q3511	8-729-422-27	TRANSISTOR	2SD601A-Q			R3530	1-216-829-11	METAL CHIP	4.7K	5%	1/10W
Q3512	8-729-422-27	TRANSISTOR	2SD601A-Q			R3531	1-216-821-11	METAL CHIP	1K	5%	1/10W
Q3513	8-729-422-27	TRANSISTOR	2SD601A-Q			R3532	1-216-809-11	METAL CHIP	100	5%	1/10W
Q3514	8-729-424-02	TRANSISTOR	2SB709A-QRS-TX			R3534	1-216-821-11	METAL CHIP	1K	5%	1/10W
Q3515	8-729-422-27	TRANSISTOR	2SD601A-Q			R3535	1-216-809-11	METAL CHIP	100	5%	1/10W
Q3516	8-729-422-27	TRANSISTOR	2SD601A-Q			R3538	1-216-821-11	METAL CHIP	1K	5%	1/10W
Q3517	8-729-422-27	TRANSISTOR	2SD601A-Q			R3539	1-216-818-11	METAL CHIP	560	5%	1/10W
Q3590	6-550-409-01	TRANSISTOR	KSC2383-O			R3540	1-216-821-11	METAL CHIP	1K	5%	1/10W
<b>RESISTOR</b>						R3541	1-216-830-11	METAL CHIP	5.6K	5%	1/10W
R3301	1-216-805-11	METAL CHIP	47	5%	1/10W	R3542	1-216-818-11	METAL CHIP	560	5%	1/10W
R3302	1-216-805-11	METAL CHIP	47	5%	1/10W	R3543	1-216-821-11	METAL CHIP	1K	5%	1/10W
R3303	1-216-833-11	METAL CHIP	10K	5%	1/10W	R3544	1-216-821-11	METAL CHIP	1K	5%	1/10W
R3305	1-216-809-11	METAL CHIP	100	5%	1/10W	R3545	1-216-818-11	METAL CHIP	560	5%	1/10W
R3306	1-216-825-11	METAL CHIP	2.2K	5%	1/10W	R3547	1-216-829-11	METAL CHIP	4.7K	5%	1/10W
R3364	1-216-845-11	METAL CHIP	100K	5%	1/10W	R3548	1-216-864-11	SHORT CHIP			
R3365	1-216-842-11	METAL CHIP	56K	5%	1/10W	R3549	1-216-825-11	METAL CHIP	2.2K	5%	1/10W
R3366	1-216-850-11	METAL CHIP	270K	5%	1/10W	R3550	1-216-817-11	METAL CHIP	470	5%	1/10W
R3369	1-216-843-11	METAL CHIP	68K	5%	1/10W	R3551	1-218-686-11	METAL CHIP	560	0.50%	1/10W
R3373	1-216-809-11	METAL CHIP	100	5%	1/10W	R3552	1-216-812-11	METAL CHIP	180	5%	1/10W
R3501	1-216-833-11	METAL CHIP	10K	5%	1/10W	R3553	1-216-825-11	METAL CHIP	2.2K	5%	1/10W
R3505	1-216-864-11	SHORT CHIP				R3554	1-216-820-11	METAL CHIP	820	5%	1/10W
R3506	1-216-864-11	SHORT CHIP				R3555	1-216-834-11	METAL CHIP	12K	5%	1/10W
R3507	1-216-864-11	SHORT CHIP				R3556	1-216-839-11	METAL CHIP	33K	5%	1/10W
R3508	1-216-864-11	SHORT CHIP				R3557	1-216-821-11	METAL CHIP	1K	5%	1/10W
R3509	1-216-821-11	METAL CHIP	1K	5%	1/10W	R3558	1-216-805-11	METAL CHIP	47	5%	1/10W
R3510	1-216-817-11	METAL CHIP	470	5%	1/10W	R3559	1-216-864-11	SHORT CHIP			
R3511	1-216-817-11	METAL CHIP	470	5%	1/10W	R3560	1-216-821-11	METAL CHIP	1K	5%	1/10W
R3514	1-216-809-11	METAL CHIP	100	5%	1/10W	R3561	1-216-818-11	METAL CHIP	560	5%	1/10W
R3515	1-216-824-11	METAL CHIP	1.8K	5%	1/10W	R3563	1-216-864-11	SHORT CHIP			
R3516	1-216-824-11	METAL CHIP	1.8K	5%	1/10W	R3564	1-216-864-11	SHORT CHIP			
R3517	1-216-809-11	METAL CHIP	100	5%	1/10W	R3565	1-216-829-11	METAL CHIP	4.7K	5%	1/10W
R3518	1-216-809-11	METAL CHIP	100	5%	1/10W	R3566	1-216-825-11	METAL CHIP	2.2K	5%	1/10W
R3519	1-216-864-11	SHORT CHIP				R3567	1-216-819-11	METAL CHIP	680	5%	1/10W
R3520	1-218-708-11	METAL CHIP	4.7K	0.50%	1/10W	R3568	1-216-820-11	METAL CHIP	820	5%	1/10W
R3521	1-216-817-11	METAL CHIP	470	5%	1/10W	R3569	1-216-825-11	METAL CHIP	2.2K	5%	1/10W
R3522	1-216-817-11	METAL CHIP	470	5%	1/10W	R3570	1-216-839-11	METAL CHIP	33K	5%	1/10W
						R3571	1-216-834-11	METAL CHIP	12K	5%	1/10W





REF. NO.	PART NO.	DESCRIPTION	VALUES			REF. NO.	PART NO.	DESCRIPTION	VALUES		
R3572	1-216-821-11	METAL CHIP	1K	5%	1/10W	C3330	1-162-970-11	CERAMIC CHIP	0.01μF	10%	25V
R3573	1-216-805-11	METAL CHIP	47	5%	1/10W	C3331	1-162-970-11	CERAMIC CHIP	0.01μF	10%	25V
R3580	1-215-857-71	METAL OXIDE	10	5%	1W	C3332	1-162-970-11	CERAMIC CHIP	0.01μF	10%	25V
R3582	1-216-817-11	METAL CHIP	470	5%	1/10W	C3334	1-162-970-11	CERAMIC CHIP	0.01μF	10%	25V
R3588	1-216-818-11	METAL CHIP	560	5%	1/10W	C3335	1-164-360-11	CERAMIC CHIP	0.1μF		16V
<b>CRYSTAL</b>						C3336	1-162-970-11	CERAMIC CHIP	0.01μF	10%	25V
X3500	1-767-606-11	VIBRATOR, CRYSTAL				C3337	1-164-360-11	CERAMIC CHIP	0.1μF		16V
<b>A-1404-846-A P (VAR) BOARD, MOUNTED</b>						C3338	1-164-360-11	CERAMIC CHIP	0.1μF		16V
	4-382-854-11	SCREW (M3X10), P, SW (+)				C3339	1-126-965-91	ELECT	22μF	20%	50V
<b>CAPACITOR</b>						C3340	1-126-947-11	ELECT	47μF	20%	35V
C100	1-126-968-11	ELECT	100μF	20%	50V	C3341	1-162-970-11	CERAMIC CHIP	0.01μF	10%	25V
C102	1-126-947-11	ELECT	47μF	20%	35V	C3343	1-126-947-11	ELECT	47μF	20%	35V
C103	1-126-964-11	ELECT	10μF	20%	50V	C3390	1-104-665-11	ELECT	100μF	20%	25V
C104	1-126-967-11	ELECT	47μF	20%	50V	C3391	1-104-665-11	ELECT	100μF	20%	25V
C106	1-162-968-11	CERAMIC CHIP	0.0047μF	10%	50V	<b>CONNECTOR</b>					
C107	1-126-960-11	ELECT	1μF	20%	50V	* CN150	1-560-124-00	PLUG, CONNECTOR (2.5MM)			4P
C109	1-164-230-11	CERAMIC CHIP	220pF	5%	50V	* CN160	1-564-507-11	PLUG, CONNECTOR			4P
C110	1-165-176-11	CERAMIC CHIP	0.047μF	10%	16V	CN6600	1-695-915-11	TAB (CONTACT)			
C111	1-126-960-11	ELECT	1μF	20%	50V	<b>DIODE</b>					
C3300	1-115-156-11	CERAMIC CHIP	1μF		10V	D103	8-719-404-50	DIODE			MA111-TX
C3301	1-115-156-11	CERAMIC CHIP	1μF		10V	D104	8-719-404-50	DIODE			MA111-TX
C3302	1-115-156-11	CERAMIC CHIP	1μF		10V	D3301	8-719-404-50	DIODE			MA111-TX
C3303	1-126-947-11	ELECT	47μF	20%	35V	D3304	8-719-109-72	DIODE			RD3.9ESB2
C3304	1-164-315-11	CERAMIC CHIP	470pF	5%	50V	<b>IC</b>					
C3305	1-164-360-11	CERAMIC CHIP	0.1μF		16V	IC3301	6-701-754-01	IC			M65665ASP
C3308	1-126-947-11	ELECT	47μF	20%	35V	IC3390	8-759-701-59	IC			NJM78M09FA
C3312	1-164-315-11	CERAMIC CHIP	470pF	5%	50V	<b>CHIP CONDUCTOR</b>					
C3313	1-162-927-11	CERAMIC CHIP	100pF	5%	50V	JR001	1-216-864-11	SHORT CHIP			
C3316	1-126-947-11	ELECT	47μF	20%	35V	JR002	1-216-864-11	SHORT CHIP			
C3317	1-162-970-11	CERAMIC CHIP	0.01μF	10%	25V	<b>COIL</b>					
C3318	1-162-970-11	CERAMIC CHIP	0.01μF	10%	25V	L150	1-414-857-11	INDUCTOR			100μH
C3319	1-126-947-11	ELECT	47μF	20%	35V	L3300	1-414-267-21	INDUCTOR			10μH
C3320	1-162-970-11	CERAMIC CHIP	0.01μF	10%	25V	L3301	1-410-682-31	INDUCTOR			470μH
C3321	1-113-619-11	CERAMIC CHIP	0.47μF		10V	L3302	1-414-267-21	INDUCTOR			10μH
C3322	1-164-373-11	CERAMIC CHIP	0.033μF		25V	L3303	1-414-267-21	INDUCTOR			10μH
C3323	1-127-715-91	CERAMIC CHIP	0.22μF	10%	16V	L3390	1-412-525-31	INDUCTOR			10μH
C3324	1-162-918-11	CERAMIC CHIP	18pF	5%	50V	<b>TRANSISTOR</b>					
C3327	1-164-315-11	CERAMIC CHIP	470pF	5%	50V	Q151	8-729-424-02	TRANSISTOR			2SB709A-QRS-TX
C3328	1-162-970-11	CERAMIC CHIP	0.01μF	10%	25V	Q152	8-729-422-27	TRANSISTOR			2SD601A-Q
C3329	1-164-315-11	CERAMIC CHIP	470pF	5%	50V	Q3300	8-729-422-27	TRANSISTOR			2SD601A-Q



REF. NO.	PART NO.	DESCRIPTION	VALUES			REF. NO.	PART NO.	DESCRIPTION	VALUES		
Q3301	8-729-422-27	TRANSISTOR	2SD601A-Q			R3324	1-216-821-11	METAL CHIP	1K	5%	1/10W
Q3302	8-729-422-27	TRANSISTOR	2SD601A-Q			R3327	1-216-864-11	SHORT CHIP			
Q3304	6-550-409-01	TRANSISTOR	KSC2383-O			R3328	1-216-821-11	METAL CHIP	1K	5%	1/10W
Q3305	8-729-422-27	TRANSISTOR	2SD601A-Q			R3329	1-216-864-11	SHORT CHIP			
Q3307	8-729-424-02	TRANSISTOR	2SB709A-QRS-TX			R3330	1-216-821-11	METAL CHIP	1K	5%	1/10W
Q3308	8-729-424-02	TRANSISTOR	2SB709A-QRS-TX			R3331	1-216-821-11	METAL CHIP	1K	5%	1/10W
Q3309	8-729-424-02	TRANSISTOR	2SB709A-QRS-TX			R3335	1-215-908-00	METAL OXIDE	33	5%	3W
Q3310	8-729-422-27	TRANSISTOR	2SD601A-Q			R3336	1-216-809-11	METAL CHIP	100	5%	1/10W
Q3312	8-729-422-27	TRANSISTOR	2SD601A-Q			R3343	1-216-821-11	METAL CHIP	1K	5%	1/10W
<b>RESISTOR</b>						R3346	1-216-821-11	METAL CHIP	1K	5%	1/10W
R100	1-216-809-11	METAL CHIP	100	5%	1/10W	R3347	1-216-833-11	METAL CHIP	10K	5%	1/10W
R101	1-216-809-11	METAL CHIP	100	5%	1/10W	R3348	1-216-833-11	METAL CHIP	10K	5%	1/10W
R103	1-216-837-11	METAL CHIP	22K	5%	1/10W	R3350	1-216-864-11	SHORT CHIP			
R104	1-216-839-11	METAL CHIP	33K	5%	1/10W	R3351	1-216-813-11	METAL CHIP	220	5%	1/10W
R105	1-216-809-11	METAL CHIP	100	5%	1/10W	R3354	1-216-863-11	METAL CHIP	3.3M	5%	1/10W
R106	1-216-817-11	METAL CHIP	470	5%	1/10W	R3359	1-216-864-11	SHORT CHIP			
R107	1-216-818-11	METAL CHIP	560	5%	1/10W	R3360	1-216-864-11	SHORT CHIP			
R108	1-216-825-11	METAL CHIP	2.2K	5%	1/10W	R3361	1-216-864-11	SHORT CHIP			
R112	1-216-825-11	METAL CHIP	2.2K	5%	1/10W	R3362	1-216-827-11	METAL CHIP	3.3K	5%	1/10W
R113	1-216-845-11	METAL CHIP	100K	5%	1/10W	R3363	1-216-839-11	METAL CHIP	33K	5%	1/10W
R114	1-216-857-11	METAL CHIP	1M	5%	1/10W	R3364	1-247-807-31	CARBON	100	5%	1/4W
R115	1-216-833-11	METAL CHIP	10K	5%	1/10W	R3365	1-247-807-31	CARBON	100	5%	1/4W
R116	1-216-833-11	METAL CHIP	10K	5%	1/10W	R3368	1-216-833-11	METAL CHIP	10K	5%	1/10W
R117	1-216-829-11	METAL CHIP	4.7K	5%	1/10W	R3369	1-216-864-11	SHORT CHIP			
R3300	1-216-841-11	METAL CHIP	47K	5%	1/10W	R3372	1-216-864-11	SHORT CHIP			
R3301	1-216-821-11	METAL CHIP	1K	5%	1/10W	R3374	1-216-864-11	SHORT CHIP			
R3302	1-216-841-11	METAL CHIP	47K	5%	1/10W	R3390	1-216-395-00	METAL OXIDE	3.3	5%	3W
R3303	1-216-821-11	METAL CHIP	1K	5%	1/10W	<b>TUNER</b>					
R3304	1-216-821-11	METAL CHIP	1K	5%	1/10W	TU150	8-598-594-30	TUNER, FSS BTF-FA421			
R3305	1-216-841-11	METAL CHIP	47K	5%	1/10W	<b>CRYSTAL</b>					
R3306	1-216-837-11	METAL CHIP	22K	5%	1/10W	X3301	1-781-377-21	VIBRATOR, CRYSTAL			
R3307	1-216-821-11	METAL CHIP	1K	5%	1/10W						
R3308	1-216-837-11	METAL CHIP	22K	5%	1/10W	Due to the complexity of this board, performing component level field repairs is not recommended. If service is required, complete board replacement is the preferred repair method. Data is provided for reference only.					
R3309	1-216-817-11	METAL CHIP	470	5%	1/10W	* A-1404-854-A Y BOARD, MOUNTED					
R3310	1-216-841-11	METAL CHIP	47K	5%	1/10W	<b>CAPACITOR</b>					
R3311	1-216-819-11	METAL CHIP	680	5%	1/10W	C3000	1-126-947-11	ELECT	47µF	20%	35V
R3312	1-216-864-11	SHORT CHIP				C3001	1-125-837-91	CERAMIC CHIP	1µF	10%	6.3V
R3313	1-216-864-11	SHORT CHIP				C3002	1-126-947-11	ELECT	47µF	20%	35V
R3314	1-216-864-11	SHORT CHIP				C3003	1-125-837-91	CERAMIC CHIP	1µF	10%	6.3V
R3318	1-216-833-11	METAL CHIP	10K	5%	1/10W	C3004	1-126-947-11	ELECT	47µF	20%	35V
R3319	1-216-833-11	METAL CHIP	10K	5%	1/10W						
R3320	1-216-829-11	METAL CHIP	4.7K	5%	1/10W						
R3321	1-216-864-11	SHORT CHIP									
R3323	1-249-414-11	CARBON	560	5%	1/4W						





REF. NO.	PART NO.	DESCRIPTION	VALUES			REF. NO.	PART NO.	DESCRIPTION	VALUES		
C3005	1-125-837-91	CERAMIC CHIP	1μF	10%	6.3V	C3063	1-126-960-11	ELECT	1μF	20%	50V
C3006	1-125-891-11	CERAMIC CHIP	0.47μF	10%	10V	C3064	1-107-826-11	CERAMIC CHIP	0.1μF	10%	16V
C3007	1-162-964-11	CERAMIC CHIP	0.001μF	10%	50V						
C3008	1-126-947-11	ELECT	47μF	20%	35V			<b><u>DELAY LINE</u></b>			
C3009	1-125-837-91	CERAMIC CHIP	1μF	10%	6.3V	DL3000	1-234-821-11	Y DELAY LINE			
						DL3001	1-234-821-11	Y DELAY LINE			
C3010	1-126-947-11	ELECT	47μF	20%	35V			<b><u>FERRITE BEAD</u></b>			
C3011	1-126-947-11	ELECT	47μF	20%	35V						
C3012	1-127-715-91	CERAMIC CHIP	0.22μF	10%	16V						
C3013	1-164-227-11	CERAMIC CHIP	0.022μF	10%	25V	*	FB3001	1-469-670-21	FERRITE	0μH	
C3014	1-127-715-91	CERAMIC CHIP	0.22μF	10%	16V	*	FB3002	1-469-670-21	FERRITE	0μH	
								<b><u>IC</u></b>			
C3015	1-125-891-11	CERAMIC CHIP	0.47μF	10%	10V	IC3000	8-759-458-18	IC			TDA8501T
C3019	1-127-715-91	CERAMIC CHIP	0.22μF	10%	16V	IC3001	8-759-443-11	IC			NJM2283M-TE1
C3020	1-126-947-11	ELECT	47μF	20%	35V	IC3002	8-759-346-81	IC			NJM2257M(TE2)
C3021	1-164-227-11	CERAMIC CHIP	0.022μF	10%	25V	IC3003	6-704-300-01	IC			ICS1578
C3023	1-126-947-11	ELECT	47μF	20%	35V	IC3004	8-759-828-44	IC			NJM2870F33(TE2)
								<b><u>COIL</u></b>			
C3025	1-125-837-91	CERAMIC CHIP	1μF	10%	6.3V	L3000	1-469-555-21	INDUCTOR			10μH
C3026	1-126-947-11	ELECT	47μF	20%	35V	L3001	1-469-555-21	INDUCTOR			10μH
C3027	1-125-837-91	CERAMIC CHIP	1μF	10%	6.3V	L3003	1-469-555-21	INDUCTOR			10μH
C3028	1-164-227-11	CERAMIC CHIP	0.022μF	10%	25V	L3004	1-469-555-21	INDUCTOR			10μH
C3029	1-126-947-11	ELECT	47μF	20%	35V	L3005	1-469-555-21	INDUCTOR			10μH
						L3006	1-469-555-21	INDUCTOR			10μH
C3033	1-115-467-11	CERAMIC CHIP	0.22μF	10%	10V			<b><u>TRANSISTOR</u></b>			
C3034	1-125-837-91	CERAMIC CHIP	1μF	10%	6.3V	Q3000	8-729-422-27	TRANSISTOR			2SD601A-Q
C3035	1-115-416-11	CERAMIC CHIP	0.001μF	5%	25V	Q3001	8-729-424-02	TRANSISTOR			2SB709A-QRS-TX
C3036	1-162-967-11	CERAMIC CHIP	0.0033μF	10%	50V	Q3002	8-729-422-27	TRANSISTOR			2SD601A-Q
C3037	1-162-970-11	CERAMIC CHIP	0.01μF	10%	25V	Q3003	8-729-422-27	TRANSISTOR			2SD601A-Q
						Q3004	8-729-424-02	TRANSISTOR			2SB709A-QRS-TX
C3038	1-126-960-11	ELECT	1μF	20%	50V	Q3005	8-729-422-27	TRANSISTOR			2SD601A-Q
C3039	1-162-970-11	CERAMIC CHIP	0.01μF	10%	25V	Q3006	8-729-422-27	TRANSISTOR			2SD601A-Q
C3040	1-126-964-11	ELECT	10μF	20%	50V	Q3007	8-729-422-27	TRANSISTOR			2SD601A-Q
C3047	1-165-176-11	CERAMIC CHIP	0.047μF	10%	16V	Q3008	8-729-422-27	TRANSISTOR			2SD601A-Q
C3048	1-162-970-11	CERAMIC CHIP	0.01μF	10%	25V	Q3009	8-729-422-27	TRANSISTOR			2SD601A-Q
						Q3010	8-729-424-02	TRANSISTOR			2SB709A-QRS-TX
C3049	1-162-970-11	CERAMIC CHIP	0.01μF	10%	25V	Q3011	8-729-422-27	TRANSISTOR			2SD601A-Q
C3050	1-162-907-11	CERAMIC CHIP	2pF	0.25pF	50V	Q3012	8-729-422-27	TRANSISTOR			2SD601A-Q
C3051	1-127-965-21	FILM CHIP	0.001μF	5%	50V	Q3013	8-729-422-27	TRANSISTOR			2SD601A-Q
C3052	1-127-956-21	FILM CHIP	0.1μF	5%	16V	Q3014	8-729-422-27	TRANSISTOR			2SD601A-Q
C3053	1-162-907-11	CERAMIC CHIP	2pF	0.25pF	50V	Q3015	8-729-424-02	TRANSISTOR			2SB709A-QRS-TX
						Q3016	8-729-424-02	TRANSISTOR			2SB709A-QRS-TX
C3054	1-162-970-11	CERAMIC CHIP	0.01μF	10%	25V	Q3017	8-729-424-02	TRANSISTOR			2SB709A-QRS-TX
C3055	1-162-970-11	CERAMIC CHIP	0.01μF	10%	25V	Q3018	8-729-422-27	TRANSISTOR			2SD601A-Q
C3056	1-164-217-11	CERAMIC CHIP	150pF	5%	50V						
C3057	1-164-217-11	CERAMIC CHIP	150pF	5%	50V						
C3058	1-126-947-11	ELECT	47μF	20%	35V						
C3059	1-162-970-11	CERAMIC CHIP	0.01μF	10%	25V						
C3060	1-126-947-11	ELECT	47μF	20%	35V						
C3061	1-107-826-11	CERAMIC CHIP	0.1μF	10%	16V						
C3062	1-115-416-11	CERAMIC CHIP	0.001μF	5%	25V						



REF. NO.	PART NO.	DESCRIPTION	VALUES			REF. NO.	PART NO.	DESCRIPTION	VALUES		
Q3019	8-729-422-27	TRANSISTOR	2SD601A-Q			R3040	1-216-825-11	METAL CHIP	2.2K	5%	1/10W
	<b>RESISTOR</b>					R3041	1-218-692-11	METAL CHIP	1K	0.50%	1/10W
R3000	1-216-821-11	METAL CHIP	1K	5%	1/10W	R3042	1-218-746-11	METAL CHIP	180K	0.50%	1/10W
R3001	1-216-841-11	METAL CHIP	47K	5%	1/10W	R3043	1-216-864-11	SHORT CHIP			
R3002	1-216-841-11	METAL CHIP	47K	5%	1/10W	R3044	1-216-821-11	METAL CHIP	1K	5%	1/10W
R3003	1-218-692-11	METAL CHIP	1K	0.50%	1/10W	R3045	1-216-864-11	SHORT CHIP			
R3004	1-218-692-11	METAL CHIP	1K	0.50%	1/10W	R3046	1-216-837-11	METAL CHIP	22K	5%	1/10W
R3005	1-218-686-11	METAL CHIP	560	0.50%	1/10W	R3047	1-216-840-11	METAL CHIP	39K	5%	1/10W
R3006	1-218-668-11	METAL CHIP	100	0.50%	1/10W	R3048	1-216-809-11	METAL CHIP	100	5%	1/10W
R3007	1-216-809-11	METAL CHIP	100	5%	1/10W	R3049	1-216-841-11	METAL CHIP	47K	5%	1/10W
R3008	1-216-817-11	METAL CHIP	470	5%	1/10W	R3050	1-216-841-11	METAL CHIP	47K	5%	1/10W
R3009	1-216-821-11	METAL CHIP	1K	5%	1/10W	R3051	1-218-692-11	METAL CHIP	1K	0.50%	1/10W
R3010	1-216-821-11	METAL CHIP	1K	5%	1/10W	R3052	1-216-809-11	METAL CHIP	100	5%	1/10W
R3011	1-216-841-11	METAL CHIP	47K	5%	1/10W	R3053	1-218-692-11	METAL CHIP	1K	0.50%	1/10W
R3012	1-216-837-11	METAL CHIP	22K	5%	1/10W	R3054	1-218-672-11	METAL CHIP	150	0.50%	1/10W
R3013	1-218-692-11	METAL CHIP	1K	0.50%	1/10W	R3055	1-216-864-11	SHORT CHIP			
R3014	1-218-692-11	METAL CHIP	1K	0.50%	1/10W	R3056	1-216-817-11	METAL CHIP	470	5%	1/10W
R3015	1-216-864-11	SHORT CHIP				R3057	1-216-821-11	METAL CHIP	1K	5%	1/10W
R3016	1-218-684-11	METAL CHIP	470	0.50%	1/10W	R3058	1-216-809-11	METAL CHIP	100	5%	1/10W
R3017	1-216-817-11	METAL CHIP	470	5%	1/10W	R3059	1-216-841-11	METAL CHIP	47K	5%	1/10W
R3018	1-216-809-11	METAL CHIP	100	5%	1/10W	R3060	1-216-841-11	METAL CHIP	47K	5%	1/10W
R3019	1-218-692-11	METAL CHIP	1K	0.50%	1/10W	R3061	1-216-821-11	METAL CHIP	1K	5%	1/10W
R3020	1-218-692-11	METAL CHIP	1K	0.50%	1/10W	R3062	1-216-821-11	METAL CHIP	1K	5%	1/10W
R3021	1-216-821-11	METAL CHIP	1K	5%	1/10W	R3063	1-216-809-11	METAL CHIP	100	5%	1/10W
R3022	1-216-821-11	METAL CHIP	1K	5%	1/10W	R3064	1-216-813-11	METAL CHIP	220	5%	1/10W
R3023	1-216-841-11	METAL CHIP	47K	5%	1/10W	R3065	1-216-817-11	METAL CHIP	470	5%	1/10W
R3024	1-216-837-11	METAL CHIP	22K	5%	1/10W	R3066	1-216-821-11	METAL CHIP	1K	5%	1/10W
R3025	1-218-692-11	METAL CHIP	1K	0.50%	1/10W	R3067	1-216-809-11	METAL CHIP	100	5%	1/10W
R3026	1-218-688-11	METAL CHIP	680	0.50%	1/10W	R3071	1-218-694-11	METAL CHIP	1.2K	0.50%	1/10W
R3027	1-218-688-11	METAL CHIP	680	0.50%	1/10W	R3072	1-218-660-91	METAL CHIP	47	0.50%	1/10W
R3028	1-218-680-11	METAL CHIP	330	0.50%	1/10W	R3073	1-216-833-11	METAL CHIP	10K	5%	1/10W
R3029	1-216-809-11	METAL CHIP	100	5%	1/10W	R3074	1-218-716-11	METAL CHIP	10K	0.50%	1/10W
R3030	1-216-817-11	METAL CHIP	470	5%	1/10W	R3075	1-218-700-11	METAL CHIP	2.2K	0.50%	1/10W
R3031	1-218-692-11	METAL CHIP	1K	0.50%	1/10W	R3076	1-218-740-11	METAL CHIP	100K	0.50%	1/10W
R3032	1-218-692-11	METAL CHIP	1K	0.50%	1/10W	R3077	1-216-855-11	METAL CHIP	680K	5%	1/10W
R3033	1-216-821-11	METAL CHIP	1K	5%	1/10W	R3078	1-218-726-11	METAL CHIP	27K	0.50%	1/10W
R3034	1-216-817-11	METAL CHIP	470	5%	1/10W	R3079	1-218-724-11	METAL CHIP	22K	0.50%	1/10W
R3035	1-218-734-11	METAL CHIP	56K	0.50%	1/10W	R3080	1-218-706-11	METAL CHIP	3.9K	0.50%	1/10W
R3036	1-216-853-11	METAL CHIP	470K	5%	1/10W	R3081	1-216-833-11	METAL CHIP	10K	5%	1/10W
R3037	1-216-821-11	METAL CHIP	1K	5%	1/10W	R3082	1-218-698-11	METAL CHIP	1.8K	0.50%	1/10W
R3038	1-216-825-11	METAL CHIP	2.2K	5%	1/10W	R3083	1-218-672-11	METAL CHIP	150	0.50%	1/10W
R3039	1-216-813-11	METAL CHIP	220	5%	1/10W	R3084	1-218-672-11	METAL CHIP	150	0.50%	1/10W
						R3085	1-218-730-11	METAL CHIP	39K	0.50%	1/10W
						R3087	1-216-864-11	SHORT CHIP			



NOTE: The components identified by shading and  $\Delta$  mark are critical for safety. Replace only with part number specified.

NOTE: Les composants identifiés par un trame et une marque  $\Delta$  sont critiques pour la sécurité. Ne les remplacer que par une pièce portant le numéro spécifique.

REF. NO.	PART NO.	DESCRIPTION	VALUES			REF. NO.	PART NO.	DESCRIPTION	VALUES		
R3088	1-218-775-11	METAL CHIP	910K	0.50%	1/10W	R2236	1-249-441-11	CARBON	100K	5%	1/4W
R3089	1-240-913-91	RES-CHIP	3.9M	5%	1/10W	R2237	1-249-409-11	CARBON	220	5%	1/4W
R3090	1-216-864-11	SHORT CHIP				R2238	1-249-441-11	CARBON	100K	5%	1/4W
R3094	1-216-841-11	METAL CHIP	47K	5%	1/10W	R2239	1-247-804-11	CARBON	75	5%	1/4W
R3095	1-216-837-11	METAL CHIP	22K	5%	1/10W	R2240	1-247-804-11	CARBON	75	5%	1/4W
R3096	1-216-845-11	METAL CHIP	100K	5%	1/10W	R2241	1-247-804-11	CARBON	75	5%	1/4W
R3097	1-216-864-11	SHORT CHIP				<b>SWITCH</b>					
R3098	1-216-845-11	METAL CHIP	100K	5%	1/10W	S1007	1-762-816-11	SWITCH, TACTILE			
<b>CRYSTAL</b>						S1008	1-762-816-11	SWITCH, TACTILE			
X3001	1-579-583-11	VIBRATOR, CERAMIC				S2001	1-692-431-21	SWITCH, TACTILE			
X3002	1-795-976-11	VIBRATOR, CRYSTAL				S2002	1-692-431-21	SWITCH, TACTILE			
<b>HU</b>						S2003	1-692-431-21	SWITCH, TACTILE			
*	<b>A-1404-855-A</b>	<b>HU (VAR) BOARD, MOUNTED</b>									
<b>CAPACITOR</b>						S2004	1-692-431-21	SWITCH, TACTILE			
C2234	1-137-194-81	FILM	0.47 $\mu$ F	5%	50V	S2005	1-692-431-21	SWITCH, TACTILE			
C2235	1-137-194-81	FILM	0.47 $\mu$ F	5%	50V	<b>HD</b>					
C2240	1-126-959-11	ELECT	0.47 $\mu$ F	20%	50V	*	<b>A-1404-896-A</b>	<b>HD BOARD, MOUNTED (SPACER BOARD)</b>	<b>(KV-32FV310/36FV310 ONLY)</b>		
C2241	1-126-959-11	ELECT	0.47 $\mu$ F	20%	50V	<b>D</b>					
<b>CONNECTOR</b>						*	<b>A-1404-852-A</b>	<b>D (VAR) BOARD, MOUNTED</b>	<b>(KV-27FV310/29FV310(N) ONLY)</b>		
* CN1001	1-564-506-11	PLUG, CONNECTOR	3P								
* CN1003	1-564-511-11	PLUG, CONNECTOR	8P								
<b>DIODE</b>						*	<b>A-1404-897-A</b>	<b>D (VAR) BOARD, MOUNTED</b>	<b>(KV-32FV310/36FV310 ONLY)</b>		
D301	8-719-108-12	DIODE	RD9.1EW								
D302	8-719-108-12	DIODE	RD9.1EW								
D2235	8-719-108-12	DIODE	RD9.1EW								
D2236	8-719-108-12	DIODE	RD9.1EW								
<b>JACK</b>						*	<b>A-1405-114-A</b>	<b>D (VAR) BOARD, MOUNTED</b>	<b>(KV-27FV310(S) ONLY)</b>		
J2231	1-794-048-11	JACK, PIN	3P								
J2232	1-694-242-11	TERMINAL, S									
<b>RESISTOR</b>						The high-voltage leads associated with the FBT on the D board are not included and must be ordered separately. Order the following leads when requesting this D board:					
R1001	1-249-425-11	CARBON	4.7K	5%	1/4W	$\Delta$	1-251-374-14	CAP ASSY, HIGH-VOLTAGE	<b>(KV-27FV310/29FV310 ONLY)</b>		
R1002	1-249-420-11	CARBON	1.8K	5%	1/4W	$\Delta$	1-251-715-22	CAP ASSY, HIGH-VOLTAGE	<b>(KV-32FV310 ONLY)</b>		
R1003	1-249-417-11	CARBON	1K	5%	1/4W	$\Delta$	1-251-715-32	CAP ASSY, HIGH-VOLTAGE	<b>(KV-36FV310 ONLY)</b>		
R2008	1-249-425-11	CARBON	4.7K	5%	1/4W	$\Delta$	1-900-805-19	WIRE ASSY, FOCUS HV			
R2009	1-249-420-11	CARBON	1.8K	5%	1/4W	$\Delta$	1-900-805-22	CONNECTOR ASSY, G2 HV			
R2010	1-249-417-11	CARBON	1K	5%	1/4W		3-710-578-01	COVER, VOLUME, 6 MOLD			
R2011	1-249-416-11	CARBON	820	5%	1/4W		4-382-854-11	SCREW (M3X10), P, SW (+)			
R2235	1-249-409-11	CARBON	220	5%	1/4W	<b>CAPACITOR</b>					
						C8001	1-126-964-11	ELECT	10 $\mu$ F	20%	50V
						C8002	1-126-964-11	ELECT	10 $\mu$ F	20%	50V
						C8003	1-162-970-11	CERAMIC CHIP	0.01 $\mu$ F	10%	25V
						C8004	1-162-970-11	CERAMIC CHIP	0.01 $\mu$ F	10%	25V
						C8006	1-126-960-11	ELECT	1 $\mu$ F	20%	50V

NOTE: The components identified by shading and  $\triangle$  mark are critical for safety. Replace only with part number specified.

NOTE: Les composants identifiés par un triangle et une marque  $\triangle$  sont critiques pour la sécurité. Ne les remplacer que par une pièce portant le numéro spécifique.











REF. NO.	PART NO.	DESCRIPTION	VALUES	REF. NO.	PART NO.	DESCRIPTION	VALUES
C8007	1-162-971-11	CERAMIC CHIP	0.001 $\mu$ F 10% 50V	C8425	1-107-826-11	CERAMIC CHIP	0.1 $\mu$ F 10% 16V
C8009	1-104-665-11	ELECT	100 $\mu$ F 20% 25V	C8426	1-162-927-11	CERAMIC CHIP	100pF 5% 50V
C8012	1-126-947-11	ELECT	47 $\mu$ F 20% 35V	C8427	1-126-947-11	ELECT	47 $\mu$ F 20% 35V
C8015	1-126-947-11	ELECT	47 $\mu$ F 20% 35V	C8428	1-126-943-11	ELECT	2200 $\mu$ F 20% 25V
C8016	1-130-495-00	MYLAR	0.1 $\mu$ F 5% 50V	C8430	1-126-960-11	ELECT	1 $\mu$ F 20% 50V
C8017	1-126-964-11	ELECT	10 $\mu$ F 20% 50V	C8512	1-129-709-91	FILM	0.0039 $\mu$ F 5% 630V
C8018	1-126-964-11	ELECT	10 $\mu$ F 20% 50V			(KV-27FV310/29FV310(N) ONLY)	
C8020	1-130-495-00	MYLAR	0.1 $\mu$ F 5% 50V	C8512	1-129-928-00	FILM	0.0027 $\mu$ F 10% 630V
C8021	1-162-971-11	CERAMIC CHIP	0.001 $\mu$ F 10% 50V			(KV-32FV310/36FV310 ONLY)	
C8024	1-126-967-11	ELECT	47 $\mu$ F 20% 50V	C8512	1-136-558-11	FILM	0.0039 $\mu$ F 5% 630V
C8025	1-126-947-11	ELECT	47 $\mu$ F 20% 35V			(KV-29FV310(S) ONLY)	
C8027	1-130-495-00	MYLAR	0.1 $\mu$ F 5% 50V	C8542	1-102-244-00	CERAMIC	220pF 500V
C8028	1-162-966-11	CERAMIC CHIP	0.0022 $\mu$ F 10% 50V			(KV-27FV310/29FV310 ONLY)	
C8030	1-162-970-11	CERAMIC CHIP	0.01 $\mu$ F 10% 25V	C8544	1-129-718-00	FILM	0.022 $\mu$ F 5% 630V
C8031	1-128-551-11	ELECT	22 $\mu$ F 20% 63V	C8550	1-102-002-00	CERAMIC	680pF 500V
C8032	1-136-813-11	FILM	680pF 5% 100V			(KV-27FV310/29FV310 ONLY)	
C8033	1-126-964-11	ELECT	10 $\mu$ F 20% 50V	C8550	1-164-645-11	CERAMIC	1000pF 500V
C8035	1-162-115-00	CERAMIC	330pF 10% 1KV			(KV-32FV310/36FV310 ONLY)	
C8036	1-162-115-00	CERAMIC	330pF 10% 1KV	C8551	1-109-954-11	ELECT	0.47 $\mu$ F 20% 160V
C8037	1-165-953-11	FILM	47000pF 3% 800V	C8552	1-102-244-00	CERAMIC	220pF 10% 500V
C8040	1-126-969-11	ELECT	220 $\mu$ F 20% 50V	C8573	1-104-665-11	ELECT	100 $\mu$ F 20% 25V
C8041	1-130-495-00	MYLAR	0.1 $\mu$ F 5% 50V			<b>CONNECTOR</b>	
C8042	1-136-189-00	MYLAR	0.1 $\mu$ F 10% 250V	CN8004	1-695-915-11	TAB (CONTACT)	
C8045	1-130-471-00	MYLAR	0.001 $\mu$ F 5% 50V	*	CN8402	1-564-510-11	PLUG, CONNECTOR 7P
C8048	1-130-495-00	MYLAR	0.1 $\mu$ F 5% 50V	*	CN8601	1-580-843-11	PIN, CONNECTOR (POWER)
C8063	1-165-607-91	FILM	10000pF 3% 800V		CN8603	1-564-320-00	PIN, CONNECTOR(3.96MM PITCH) 2P
C8065	1-127-715-91	CERAMIC CHIP	0.22 $\mu$ F 10% 16V	*	CN8604	1-564-511-11	PLUG, CONNECTOR 8P
C8073	1-162-962-11	CERAMIC CHIP	470pF 10% 50V	*	CN8605	1-564-507-11	PLUG, CONNECTOR 4P
C8075	1-162-970-11	CERAMIC CHIP	0.01 $\mu$ F 10% 25V			<b>DIODE</b>	
C8076	1-126-963-11	ELECT	4.7 $\mu$ F 20% 50V	D5007	8-719-404-50	DIODE	MA111-TX
C8077	1-162-970-11	CERAMIC CHIP	0.01 $\mu$ F 10% 25V	D8001	8-719-404-50	DIODE	MA111-TX
C8080	1-117-228-71	MYLAR	2.2 $\mu$ F 10% 450V	D8003	8-719-404-50	DIODE	MA111-TX
C8139	1-162-966-11	CERAMIC CHIP	0.0022 $\mu$ F 10% 50V	D8005	8-719-404-50	DIODE	MA111-TX
C8301	1-104-665-11	ELECT	100 $\mu$ F 20% 25V	D8006	8-719-063-74	DIODE	D1NL20U-TR2
C8302	1-162-970-11	CERAMIC CHIP	0.01 $\mu$ F 10% 25V	D8007	8-719-404-50	DIODE	MA111-TX
C8407	1-125-891-11	CERAMIC CHIP	0.47 $\mu$ F 10% 10V	D8009	8-719-083-83	DIODE	UDZS-TE17-15B
C8411	1-126-965-91	ELECT	22 $\mu$ F 20% 50V	D8010	8-719-979-64	DIODE	$\mu$ F4005PKG23
C8412	1-137-194-81	FILM	0.47 $\mu$ F 5% 50V	D8011	8-719-110-41	DIODE	RD15ESB2
C8413	1-100-120-51	ELECT	1000 $\mu$ F 20% 35V	D8012	8-719-110-41	DIODE	RD15ESB2
C8415	1-126-963-11	ELECT	4.7 $\mu$ F 20% 50V	D8013	8-719-083-83	DIODE	UDZS-TE17-15B
C8420	1-125-891-11	CERAMIC CHIP	0.47 $\mu$ F 10% 10V	D8014	8-719-083-83	DIODE	UDZS-TE17-15B
C8421	1-125-891-11	CERAMIC CHIP	0.47 $\mu$ F 10% 10V	D8015	8-719-404-50	DIODE	MA111-TX
C8423	1-165-176-11	CERAMIC CHIP	0.047 $\mu$ F 10% 16V	D8019	8-719-109-85	DIODE	RD5.1ESB2
C8424	1-162-969-11	CERAMIC CHIP	0.0068 $\mu$ F 10% 25V	$\triangle$ D8022	8-719-063-74	DIODE	D1NL20U-TR2

NOTE: The components identified by shading and  mark are critical for safety. Replace only with part number specified.

NOTE: Les composants identifiés par un trame et une  sont critiques pour la sécurité. Ne les remplacer que par une pièce portant le numéro spécifié.



























REF. NO.	PART NO.	DESCRIPTION	VALUES	REF. NO.	PART NO.	DESCRIPTION	VALUES
D8023	8-719-109-85	DIODE	RD5.1ESB2	<b>COIL</b>			
D8024	8-719-109-93	DIODE	RD6.2ESB2	L8001	1-414-189-31	INDUCTOR	100µH
D8026	8-719-404-50	DIODE	MA111-TX	L8002	1-428-950-11	INDUCTOR	125µH
D8030	8-719-083-66	DIODE	UDZSTE-1718B	L8504	1-406-677-11	INDUCTOR	10MH
D8034	8-719-109-85	DIODE	RD5.1ESB2	L8600	1-406-977-21	INDUCTOR	100µH
D8140	8-719-404-50	DIODE	MA111-TX	<b>PHOTO COUPLER</b>			
D8301	8-719-069-54	DIODE	UDZSTE-175.1B	PH8001	8-749-016-81	PHOTO COUPLER	PC123Y22
D8400	8-719-991-33	DIODE	1SS133T-77	 PH8003	8-749-016-81	PHOTO COUPLER	PC123Y22
D8510	8-719-081-93	DIODE	1N4937/23	 PH8004	8-749-016-81	PHOTO COUPLER	PC123Y22
D8511	8-719-970-87	DIODE	ERA38-06	<b>IC LINK</b>			
D8512	8-719-970-87	DIODE	ERA38-06	PS8401	1-576-337-21	IC LINK	2.7A 50V
D8513	8-719-110-41	DIODE	RD15ESB2	<b>TRANSISTOR</b>			
<b>FERRITE BEAD</b>				Q8003	8-729-422-27	TRANSISTOR	2SD601A-Q
FB8001	1-412-911-11	FERRITE	0µH	Q8004	8-729-422-27	TRANSISTOR	2SD601A-Q
FB8002	1-412-911-11	FERRITE	0µH	Q8007	8-729-422-27	TRANSISTOR	2SD601A-Q
FB8504	1-410-397-21	FERRITE	1.1µH	Q8008	8-729-422-27	TRANSISTOR	2SD601A-Q
<b>IC</b>				Q8011	8-729-424-02	TRANSISTOR	2SB709A-QRS-TX
 IC8001	8-759-700-07	IC	NJM2903M	Q8013	8-729-052-32	TRANSISTOR	IRFIB7N50A-LF31
IC8002	8-759-670-30	IC	MCZ3001D	Q8014	8-729-052-32	TRANSISTOR	IRFIB7N50A-LF31
 IC8004	8-759-701-01	IC	NJM2904M	Q8021	8-729-424-02	TRANSISTOR	2SB709A-QRS-TX
 IC8005	8-759-198-31	IC	UPC1093J-1-T	Q8028	8-729-422-27	TRANSISTOR	2SD601A-Q
IC8006	8-759-700-07	IC	NJM2903M	Q8034	8-729-422-27	TRANSISTOR	2SD601A-Q
 IC8104	8-759-586-17	IC	TL1431CZ-AP	Q8035	8-729-424-02	TRANSISTOR	2SB709A-QRS-TX
IC8401	6-704-065-01	IC	TFA9844J	Q8400	8-729-120-28	TRANSISTOR	2SC1623-L5L6
IC8402	8-759-100-96	IC	UPC4558G2	Q8401	8-729-120-28	TRANSISTOR	2SC1623-L5L6
<b>CHIP CONDUCTOR</b>				Q8507	8-729-043-95	TRANSISTOR	2SC3840(3)
JR8002	1-216-864-11	SHORT CHIP		<b>RESISTOR</b>			
JR8005	1-216-864-11	SHORT CHIP		R8001	1-216-809-11	METAL CHIP	100 5% 1/10W
JR8006	1-216-864-11	SHORT CHIP		R8002	1-249-417-11	CARBON	1K 5% 1/4W
JR8007	1-216-864-11	SHORT CHIP		R8003	1-216-837-11	METAL CHIP	22K 5% 1/10W
JR8008	1-216-864-11	SHORT CHIP		R8004	1-216-829-11	METAL CHIP	4.7K 5% 1/10W
JR8009	1-216-864-11	SHORT CHIP		R8005	1-216-837-11	METAL CHIP	22K 5% 1/10W
JR8010	1-216-864-11	SHORT CHIP		R8006	1-219-512-11	METAL	2.2M 5% 1/2W
JR8011	1-216-864-11	SHORT CHIP		R8007	1-219-512-11	METAL	2.2M 5% 1/2W
JR8012	1-216-864-11	SHORT CHIP		 R8009	1-218-877-11	METAL CHIP	18K 0.5% 1/10W
JR8100	1-216-864-11	SHORT CHIP		(KV-27FV310/29FV310 ONLY)			
JR8101	1-216-864-11	SHORT CHIP		R8011	1-216-849-11	METAL CHIP	220K 5% 1/10W
JR8102	1-216-864-11	SHORT CHIP		R8012	1-249-419-11	CARBON	1.5K 5% 1/4W
JR8103	1-216-864-11	SHORT CHIP		R8013	1-216-833-11	METAL CHIP	10K 5% 1/10W
				 R8014	1-218-847-11	METAL CHIP	1K 0.50% 1/10W
				 R8015	1-218-855-11	METAL CHIP	2.2K 0.50% 1/10W





NOTE: The components identified by shading and  mark are critical for safety. Replace only with part number specified.

NOTE: Les composants identifiés par un trame et une  sont critiques pour la sécurité. Ne les remplacer que par une pièce portant le numéro spécifique.







REF. NO.	PART NO.	DESCRIPTION	VALUES			REF. NO.	PART NO.	DESCRIPTION	VALUES		
	R8016	1-247-843-11 CARBON	3.3K	5%	1/4W	R8057	1-218-874-11 METAL CHIP	13K	0.50%	1/10W	
	R8017	1-218-857-11 METAL CHIP (KV-27FV310/29FV310 ONLY)	2.7K	0.50%	1/10W	R8058	1-249-393-11 CARBON	10	5%	1/4W	
	R8017	1-218-858-11 METAL CHIP (KV-32FV310/36FV310 ONLY)	3K	0.50%	1/10W	R8059	1-216-864-11 SHORT CHIP				
	R8019	1-218-895-11 METAL CHIP	100K	0.50%	1/10W	R8060	1-216-817-11 METAL CHIP	470	5%	1/10W	
	R8020	1-216-833-11 METAL CHIP	10K	5%	1/10W	R8061	1-249-393-11 CARBON	10	5%	1/4W	
	R8021	1-218-847-11 METAL CHIP (KV-32FV310/36FV310 ONLY)	1K	0.50%	1/10W	R8062	1-216-833-11 METAL CHIP	10K	5%	1/10W	
	R8021	1-218-877-11 METAL CHIP (KV-27FV310/29FV310 ONLY)	18K	0.50%	1/10W	R8063	1-216-833-11 METAL CHIP	10K	5%	1/10W	
	R8022	1-216-833-11 METAL CHIP	10K	5%	1/10W	R8066	1-216-821-11 METAL CHIP	1K	5%	1/10W	
	R8024	1-216-833-11 METAL CHIP	10K	5%	1/10W	R8069	1-216-829-11 METAL CHIP	4.7K	5%	1/10W	
	R8027	1-218-891-11 METAL CHIP	68K	0.50%	1/10W	R8070	1-243-979-71 METAL OXIDE	0.1	5%	2W	
	R8029	1-218-891-11 METAL CHIP	68K	0.50%	1/10W		R8072	1-249-377-11 CARBON	0.47	5%	1/4W
	R8030	1-218-895-11 METAL CHIP	100K	0.50%	1/10W		R8076	1-240-931-91 METAL	330	5%	0.5W
	R8031	1-218-895-11 METAL CHIP	100K	0.50%	1/10W		R8078	1-218-897-11 METAL CHIP	120K	0.50%	1/10W
	R8034	1-216-857-11 METAL CHIP	1M	5%	1/10W		R8079	1-249-431-11 CARBON	15K	5%	1/4W
	R8035	1-218-861-11 METAL CHIP	3.9K	0.50%	1/10W		R8082	1-216-863-11 METAL CHIP	3.3M	5%	1/10W
	R8036	1-215-421-00 METAL	1K	1%	1/4W		R8085	1-219-749-91 METAL	10K	5%	1/2W
	R8037	1-215-447-00 METAL	12K	1%	1/4W		R8086	1-219-751-91 METAL	47K	5%	1/2W
	R8038	1-215-447-00 METAL	12K	1%	1/4W		R8087	1-216-864-11 SHORT CHIP			
	R8039	1-215-447-00 METAL	12K	1%	1/4W		R8088	1-216-833-11 METAL CHIP	10K	5%	1/10W
	R8040	1-215-433-00 METAL (KV-32FV310/36FV310 ONLY)	3.3K	1%	1/4W		R8090	1-216-833-11 METAL CHIP	10K	5%	1/10W
	R8040	1-215-443-00 METAL (KV-27FV310/29FV310 ONLY)	8.2K	1%	1/4W		R8091	1-215-485-00 METAL	470K	1%	1/4W
	R8041	1-216-864-11 SHORT CHIP					R8095	1-215-485-00 METAL	470K	1%	1/4W
	R8043	1-215-447-00 METAL	12K	1%	1/4W		R8096	1-216-864-11 SHORT CHIP			
	R8045	1-216-857-11 METAL CHIP	1M	5%	1/10W		R8097	1-216-797-11 METAL CHIP	10	5%	1/10W
	R8046	1-218-843-11 METAL CHIP (KV-27FV310/29FV310 ONLY)	680	0.50%	1/10W		R8106	1-249-377-11 CARBON	0.47	5%	1/4W
	R8046	1-218-847-11 METAL CHIP (KV-32FV310/36FV310 ONLY)	1K	0.50%	1/10W		R8135	1-218-867-11 METAL CHIP	6.8K	0.50%	1/10W
	R8049	1-218-823-11 METAL CHIP	100	0.50%	1/10W		R8136	1-216-825-11 METAL CHIP	2.2K	5%	1/10W
	R8050	1-211-981-11 METAL CHIP	33	0.50%	1/10W		R8137	1-216-821-11 METAL CHIP	1K	5%	1/10W
	R8051	1-202-933-61 FUSIBLE	0.1	10%	1/2W		R8138	1-216-857-11 METAL CHIP	1M	5%	1/10W
	R8052	1-218-873-11 METAL CHIP (KV-32FV310/36FV310 ONLY)	12K	0.50%	1/10W		R8144	1-216-849-11 METAL CHIP	220K	5%	1/10W
	R8052	1-218-887-11 METAL CHIP (KV-27FV310/29FV310 ONLY)	47K	0.50%	1/10W		R8145	1-216-841-11 METAL CHIP	47K	5%	1/10W
	R8054	1-245-478-21 METAL	470K	1%	1/4W		R8146	1-216-821-11 METAL CHIP	1K	5%	1/10W
	R8055	1-245-478-21 METAL	470K	1%	1/4W		R8158	1-216-809-11 METAL CHIP	100	5%	1/10W
	R8056	1-218-869-11 METAL CHIP	8.2K	0.50%	1/10W		R8159	1-216-834-11 METAL CHIP	12K	5%	1/10W
							R8160	1-216-853-11 METAL CHIP	470K	5%	1/10W
							R8161	1-218-867-11 METAL CHIP	6.8K	0.50%	1/10W
							R8200	1-216-833-11 METAL CHIP	10K	5%	1/10W
							R8203	1-216-833-11 METAL CHIP	10K	5%	1/10W
							R8206	1-216-817-11 METAL CHIP	470	5%	1/10W
							R8301	1-216-837-11 METAL CHIP	22K	5%	1/10W
							R8303	1-216-821-11 METAL CHIP	1K	5%	1/10W
							R8304	1-218-853-11 METAL CHIP	1.8K	0.50%	1/10W
							R8305	1-218-865-11 METAL CHIP	5.6K	0.50%	1/10W
							R8401	1-249-429-11 CARBON	10K	5%	1/4W

NOTE: The components identified by shading and  mark are critical for safety. Replace only with part number specified.

A component identified by this  symbol indicates that it has been carefully factory-selected to satisfy regulations regarding X-ray radiation. Should replacement be required, replace only with the value originally used.





REF. NO.	PART NO.	DESCRIPTION	VALUES			REF. NO.	PART NO.	DESCRIPTION	VALUES		
R8404	1-216-837-11	METAL CHIP	22K	5%	1/10W						
R8405	1-216-841-11	METAL CHIP	47K	5%	1/10W						
R8408	1-216-823-11	METAL CHIP	1.5K	5%	1/10W						
R8420	1-249-433-11	CARBON	22K	5%	1/4W						
R8421	1-249-433-11	CARBON	22K	5%	1/4W						
R8422	1-216-833-11	METAL CHIP	10K	5%	1/10W						
R8423	1-216-840-11	METAL CHIP	39K	5%	1/10W						
R8424	1-216-840-11	METAL CHIP	39K	5%	1/10W						
R8425	1-216-840-11	METAL CHIP	39K	5%	1/10W						
R8426	1-216-817-11	METAL CHIP	470	5%	1/10W						
R8427	1-216-817-11	METAL CHIP	470	5%	1/10W						
R8428	1-216-829-11	METAL CHIP	4.7K	5%	1/10W						
R8429	1-216-829-11	METAL CHIP	4.7K	5%	1/10W						
R8430	1-218-847-11	METAL CHIP	1K	0.50%	1/10W						
R8431	1-218-843-11	METAL CHIP	680	0.50%	1/10W						
R8432	1-216-864-11	SHORT CHIP									
R8434	1-218-895-11	METAL CHIP	100K	0.50%	1/10W						
R8488	1-216-825-11	METAL CHIP	2.2K	5%	1/10W						
R8541	1-215-922-11	METAL OXIDE	6.8K	5%	3W						
R8542	1-215-921-11	METAL OXIDE (KV-32FV310/36FV310 ONLY)	4.7K	5%	3W						
R8542	1-216-486-00	METAL OXIDE (KV-27FV310/29FV310 ONLY)	8.2K	5%	3W						
R8548	1-215-921-11	METAL OXIDE (KV-32FV310/36FV310 ONLY)	4.7K	5%	3W						
R8548	1-216-486-00	METAL OXIDE (KV-27FV310/29FV310 ONLY)	8.2K	5%	3W						
R8554	1-215-876-00	METAL OXIDE (KV-27FV310/29FV310 ONLY)	15K	5%	1W						
R8554	1-215-894-11	METAL OXIDE (KV-32FV310/36FV310 ONLY)	2.2K	5%	2W						
R8555	1-249-441-11	CARBON	100K	5%	1/4W						
R8556	1-249-441-11	CARBON	100K	5%	1/4W						
R8557	1-249-441-11	CARBON	100K	5%	1/4W						
R8560	1-215-922-11	METAL OXIDE	6.8K	5%	3W						
<b>VARIABLE RESISTOR</b>											
 	RV8002	1-225-627-91	RES, VAR, ADJ, CERMET	2K							
<b>SPARK GAP</b>											
SG8002	1-517-499-21	GAP, SPARK									
<b>TRANSFORMER</b>											
	T8001	1-453-387-21	FBT ASSY NX-6020//M3J4 (KV-27FV310/29FV310/32FV310 ONLY)								
	T8001	1-453-389-31	FBT ASSY NX-6020//M3C4 (KV-36FV310 ONLY)								
	T8504	1-433-533-12	TRANSFORMER, FERRITE (DFT)								
											
*		<b>A-1404-848-A</b>	<b>V (VAR) BOARD, MOUNTED (KV-27FV310/29FV310 ONLY)</b>								
*		<b>A-1404-895-A</b>	<b>V (VAR) BOARD, MOUNTED (KV-32FV310 ONLY)</b>								
*		<b>A-1404-955-A</b>	<b>V (VAR) BOARD, MOUNTED (KV-36FV310 ONLY)</b>								
		4-382-854-11	SCREW (M3X10), P, SW (+)								
<b>CAPACITOR</b>											
	C802	1-126-964-11	ELECT	10µF	20%	50V					
	C803	1-137-378-11	MYLAR	0.22µF	5%	50V					
	C804	1-137-378-11	MYLAR	0.22µF	5%	50V					
	C805	1-131-985-21	FILM	0.033µF	5%	250V					
	C808	1-162-970-11	CERAMIC CHIP	0.01µF	10%	25V					
	C809	1-128-934-91	CERAMIC CHIP	0.33µF	20%	10V					
	C810	1-130-495-00	MYLAR	0.1µF	5%	50V					
	C811	1-129-725-00	FILM	0.082µF	5%	400V					
	C812	1-162-970-11	CERAMIC CHIP	0.01µF	10%	25V					
	C813	1-126-933-11	ELECT	100µF	20%	16V					
	C821	1-162-970-11	CERAMIC CHIP	0.01µF	10%	25V					
	C823	1-130-967-00	FILM	0.0027µF	5%	50V					
	C824	1-165-176-11	CERAMIC CHIP	0.047µF	10%	16V					
	C826	1-162-927-11	CERAMIC CHIP	100pF	5%	50V					
	C862	1-126-964-11	ELECT	10µF	20%	50V					
	C901	1-107-667-11	ELECT	2.2µF	20%	400V					
	C902	1-107-364-11	MYLAR	0.01µF	10%	200V					
	C903	1-126-935-11	ELECT	470µF	20%	16V					
	C904	1-130-471-00	MYLAR	0.001µF	5%	50V					
	C905	1-107-364-11	MYLAR	0.01µF	10%	200V					
	C906	1-130-471-00	MYLAR	0.001µF	5%	50V					
	C907	1-107-963-11	ELECT	33µF	20%	250V					
	C908	1-126-935-11	ELECT	470µF	20%	16V					
	C909	1-104-999-11	MYLAR	0.1µF	5%	200V					
	C910	1-104-999-11	MYLAR	0.1µF	5%	200V					



REF. NO.	PART NO.	DESCRIPTION	VALUES	REF. NO.	PART NO.	DESCRIPTION	VALUES
C911	1-126-933-11	ELECT	100μF 20% 16V	Q902	6-550-247-01	TRANSISTOR	KTA1659A
C912	1-126-933-11	ELECT	100μF 20% 16V	Q903	8-729-422-27	TRANSISTOR	2SD601A-Q
C913	1-102-074-00	CERAMIC	0.001μF 10% 50V	Q904	8-729-422-27	TRANSISTOR	2SD601A-Q
C914	1-130-491-00	MYLAR	0.047μF 5% 50V	Q905	8-729-424-02	TRANSISTOR	2SB709A-QRS-TX
C930	1-126-935-11	ELECT	470μF 20% 16V	Q906	8-729-120-28	TRANSISTOR	2SC1623-L5L6
C931	1-126-935-11	ELECT	470μF 20% 16V	Q907	8-729-120-28	TRANSISTOR	2SC1623-L5L6
<b>CONNECTOR</b>				<b>RESISTOR</b>			
* CN901	1-764-333-11	PIN, CONNECTOR(PCB)(V TYPE)	10P	R809	1-216-829-11	METAL CHIP (KV-27FV310/29FV310 ONLY)	4.7K 5% 1/10W
* CN902	1-770-723-11	CONNECTOR, BOARD TO BOARD	8P	R809	1-216-832-11	METAL CHIP (KV-32FV310/36FV310 ONLY)	8.2K 5% 1/10W
<b>DIODE</b>				<b>RESISTOR</b>			
D804	8-719-074-25	DIODE	PG104R	R811	1-249-393-11	CARBON	10 5% 1/4W
D805	8-719-991-33	DIODE	1SS133T-77	R814	1-215-862-11	METAL OXIDE (KV-32FV310/36FV310 ONLY)	68 5% 1W
D806	8-719-991-33	DIODE	1SS133T-77	R815	1-215-862-11	METAL OXIDE	68 5% 1W
D807	8-719-210-21	DIODE	11EQS04	R817	1-218-728-11	METAL CHIP (KV-32FV310/36FV310 ONLY)	33K 0.50% 1/10W
D808	8-719-991-33	DIODE	1SS133T-77	R817	1-218-732-11	METAL CHIP (KV-27FV310/29FV310 ONLY)	47K 0.50% 1/10W
D813	8-719-991-33	DIODE	1SS133T-77	R818	1-216-809-11	METAL CHIP	100 5% 1/10W
D901	8-719-924-11	DIODE	MTZJ-T-77-22	R819	1-216-841-11	METAL CHIP	47K 5% 1/10W
D902	8-719-924-11	DIODE	MTZJ-T-77-22	R820	1-216-837-11	METAL CHIP (KV-32FV310/36FV310 ONLY)	22K 5% 1/10W
D903	8-719-991-33	DIODE	1SS133T-77	R820	1-216-839-11	METAL CHIP (KV-27FV310/29FV310 ONLY)	33K 5% 1/10W
D905	8-719-510-02	DIODE	D1NS4	R821	1-216-830-11	METAL CHIP (KV-27FV310/29FV310 ONLY)	5.6K 5% 1/10W
D906	8-719-404-50	DIODE	MA111-TX	R821	1-218-714-11	METAL CHIP (KV-32FV310/36FV310 ONLY)	8.2K 0.50% 1/10W
D907	8-719-404-50	DIODE	MA111-TX	R822	1-216-841-11	METAL CHIP	47K 5% 1/10W
D908	8-719-404-50	DIODE	MA111-TX	R824	1-218-740-11	METAL CHIP	100K 0.50% 1/10W
<b>IC</b>				R825	1-216-845-11	METAL CHIP	100K 5% 1/10W
IC801	6-701-598-01	IC	UPC5023CS-184	R826	1-249-421-11	CARBON	2.2K 5% 1/4W
<b>CHIP CONDUCTOR</b>				R827	1-218-708-11	METAL CHIP	4.7K 0.50% 1/10W
JR802	1-216-864-11	SHORT CHIP		R828	1-218-728-11	METAL CHIP	33K 0.50% 1/10W
JR803	1-216-864-11	SHORT CHIP		R829	1-216-853-11	METAL CHIP	470K 5% 1/10W
<b>COIL</b>				R833	1-218-710-11	METAL CHIP (KV-27FV310/29FV310 ONLY)	5.6K 0.50% 1/10W
L801	1-406-989-21	INDUCTOR	10MH	R833	1-218-712-11	METAL CHIP (KV-32FV310/36FV310 ONLY)	6.8K 0.50% 1/10W
L802	1-419-633-11	INDUCTOR	10MH	R834	1-218-700-11	METAL CHIP (KV-32FV310/36FV310 ONLY)	2.2K 0.50% 1/10W
L803	1-412-529-81	INDUCTOR	22μH				
L901	1-412-528-11	INDUCTOR	18μH				
<b>TRANSISTOR</b>							
Q805	6-550-106-01	TRANSISTOR	KTB764				
Q807	8-729-931-45	TRANSISTOR	IRF614				
Q808	6-550-106-01	TRANSISTOR	KTB764				
Q812	8-729-026-39	TRANSISTOR	2SA933AS-QT				
Q901	8-729-053-87	TRANSISTOR	KTC4370A				



**NOTE:** The components identified by shading and  mark are critical for safety. Replace only with part number specified.

**NOTE:** Les composants identifiés per un trame et une marque  sont critiques pour la securite. Ne les remplacer que par une piece portant le numero specifique.





REF. NO.	PART NO.	DESCRIPTION	VALUES			REF. NO.	PART NO.	DESCRIPTION	VALUES		
R834	1-218-706-11	METAL CHIP (KV-27FV310/29FV310 ONLY)	3.9K	0.50%	1/10W	R910	1-215-915-11	METAL OXIDE	470	5%	3W
R837	1-218-714-11	METAL CHIP (KV-27FV310/29FV310 ONLY)	8.2K	0.50%	1/10W	R911	1-215-405-00	METAL	220	1%	1/4W
R840	1-216-824-11	METAL CHIP (KV-27FV310/29FV310 ONLY)	1.8K	5%	1/10W	R912	1-249-407-11	CARBON	150	5%	1/4W
R840	1-218-700-11	METAL CHIP (KV-32FV310/36FV310 ONLY)	2.2K	0.50%	1/10W	R913	1-215-397-00	METAL	100	1%	1/4W
R841	1-216-837-11	METAL CHIP (KV-27FV310/29FV310 ONLY)	22K	5%	1/10W	R914	1-249-416-11	CARBON	820	5%	1/4W
R841	1-218-712-11	METAL CHIP (KV-32FV310/36FV310 ONLY)	6.8K	0.50%	1/10W	R915	1-249-425-11	CARBON	4.7K	5%	1/4W
R842	1-218-700-11	METAL CHIP	2.2K	0.50%	1/10W	R917	1-249-425-11	CARBON	4.7K	5%	1/4W
R855	1-218-706-11	METAL CHIP (KV-32FV310/36FV310 ONLY)	3.9K	0.50%	1/10W	R918	1-249-401-11	CARBON	47	5%	1/4W
R855	1-218-714-11	METAL CHIP (KV-27FV310/29FV310 ONLY)	8.2K	0.50%	1/10W	R919	1-249-401-11	CARBON	47	5%	1/4W
R856	1-218-712-11	METAL CHIP (KV-27FV310/29FV310 ONLY)	6.8K	0.50%	1/10W	R921	1-249-429-11	CARBON	10K	5%	1/4W
R856	1-218-716-11	METAL CHIP (KV-32FV310/36FV310 ONLY)	10K	0.50%	1/10W	R922	1-249-397-11	CARBON	22	5%	1/4W
R857	1-218-716-11	METAL CHIP (KV-32FV310/36FV310 ONLY)	10K	0.50%	1/10W	R923	1-249-401-11	CARBON	47	5%	1/4W
R857	1-218-724-11	METAL CHIP	22K	0.50%	1/10W	R930	1-216-864-11	SHORT CHIP			
R860	1-218-716-11	METAL CHIP	10K	0.50%	1/10W	R931	1-249-421-11	CARBON	2.2K	5%	1/4W
R864	1-218-668-11	METAL CHIP	100	0.50%	1/10W	R932	1-218-696-11	METAL CHIP	1.5K	0.50%	1/10W
R866	1-249-438-11	CARBON	56K	5%	1/4W	R933	1-216-864-11	SHORT CHIP			
R870	1-216-825-11	METAL CHIP	2.2K	5%	1/10W	R935	1-249-405-11	CARBON	100	5%	1/4W
R876	1-216-821-11	METAL CHIP	1K	5%	1/10W	R938	1-216-864-11	SHORT CHIP			
R890	1-218-712-11	METAL CHIP (KV-32FV310/36FV310 ONLY)	6.8K	0.50%	1/10W						
R890	1-218-736-11	METAL CHIP (KV-27FV310/29FV310 ONLY)	68K	0.50%	1/10W						
R893	1-216-839-11	METAL CHIP	33K	5%	1/10W						
R901	1-249-405-11	CARBON	100	5%	1/4W						
R902	1-249-385-11	CARBON	2.2	5%	1/4W						
R903	1-249-414-11	CARBON	560	5%	1/4W						
R904	1-249-432-11	CARBON	18K	5%	1/4W						
R905	1-249-421-11	CARBON	2.2K	5%	1/4W						
R906	1-249-432-11	CARBON	18K	5%	1/4W						
R907	1-249-385-11	CARBON	2.2	5%	1/4W						
R908	1-249-414-11	CARBON	560	5%	1/4W						
R909	1-260-316-51	CARBON	100	5%	1/2W						



- \* A-1404-844-A GK (VAR) BOARD, MOUNTED (KV-27FV310/29FV310(N)/32FV310 ONLY)
- \* A-1404-956-A GK (VAR) BOARD, MOUNTED (KV-36FV310 ONLY)
- \* A-1405-113-A GK (VAR) BOARD, MOUNTED (KV-29FV310(S) ONLY)

- \* 1-533-223-11 FUSE HOLDER 0A 0V
- \* 4-374-846-11 COVER, CAPACITOR, CAP TYPE
- \* 4-382-854-11 SCREW (M3X10), P, SW (+)

**CAPACITOR**

C501	1-165-529-11	MYLAR	0.22µF	10	275V
C600	1-117-703-11	CERAMIC	0.0047µF		250V
					(KV-29FV310(S) ONLY)
	C601	1-165-529-11	MYLAR	0.22µF	10 275V
	C602	1-162-970-11	CERAMIC CHIP	0.01µF	10% 25V
	C603	1-165-529-11	MYLAR	0.22µF	10 275V
	C604	1-164-625-11	CERAMIC	680pF	10% 500V
	C608	1-119-912-51	CERAMIC	0.001µF	20% 125V
	C609	1-164-625-11	CERAMIC	680pF	10% 500V
	C613	1-117-214-11	CERAMIC	0.001µF	10% 2KV
					(KV-29FV310(S) ONLY)
	C614	1-117-214-11	CERAMIC	0.001µF	10% 2KV
					(KV-29FV310(S) ONLY)

NOTE: The components identified by shading and  $\triangle$  mark are critical for safety. Replace only with part number specified.

NOTE: Les composants identifiés par un trame et une marque  $\triangle$  sont critiques pour la sécurité. Ne les remplacer que par une pièce portant le numéro spécifique.



REF. NO.	PART NO.	DESCRIPTION	VALUES	REF. NO.	PART NO.	DESCRIPTION	VALUES
C615	1-117-214-11	CERAMIC (KV-29FV310(S) ONLY)	0.001 $\mu$ F 10% 2KV	C1406	1-162-970-11	CERAMIC CHIP	0.01 $\mu$ F 10% 25V
C616	1-126-943-11	ELECT	2200 $\mu$ F 20% 25V	C1407	1-162-968-11	CERAMIC CHIP	0.0047 $\mu$ F 10% 50V
C617	1-123-024-21	ELECT	33 $\mu$ F 160V	C1408	1-162-968-11	CERAMIC CHIP	0.0047 $\mu$ F 10% 50V
C618	1-126-943-11	ELECT	2200 $\mu$ F 20% 25V	C1411	1-162-968-11	CERAMIC CHIP	0.0047 $\mu$ F 10% 50V
C619	1-117-214-11	CERAMIC (KV-29FV310(S) ONLY)	0.001 $\mu$ F 10% 2KV	C1412	1-104-656-11	ELECT	2200 $\mu$ F 20% 6.3V
C620	1-162-970-11	CERAMIC CHIP	0.01 $\mu$ F 10% 25V	C1413	1-126-963-11	ELECT	4.7 $\mu$ F 20% 50V
C621	1-128-717-11	ELECT	680 $\mu$ F 20% 250V	C1420	1-126-960-11	ELECT	1 $\mu$ F 20% 50V
$\triangle$ C622	1-119-912-51	CERAMIC	0.001 $\mu$ F 20% 125V	C1450	1-100-120-51	ELECT	1000 $\mu$ F 20% 35V
C624	1-107-636-11	ELECT	10 $\mu$ F 20% 160V	C1451	1-137-194-81	FILM	0.47 $\mu$ F 5% 50V
C629	1-128-717-11	ELECT	680 $\mu$ F 20% 250V	C1458	1-162-970-11	CERAMIC CHIP	0.01 $\mu$ F 10% 25V
C632	1-126-947-11	ELECT	47 $\mu$ F 20% 35V	<b>CONNECTOR</b>			
C633	1-136-479-11	FILM	0.001 $\mu$ F 5% 100V	* CN503	1-573-963-11	PIN, CONNECTOR (PC BOARD)	
C634	1-126-964-11	ELECT	10 $\mu$ F 20% 50V	* CN600	1-580-843-11	PIN, CONNECTOR (POWER)	
C635	1-126-963-11	ELECT	4.7 $\mu$ F 20% 50V	* CN602	1-564-510-11	PLUG, CONNECTOR	7P
C637	1-136-165-00	FILM	0.1 $\mu$ F 5% 50V	* CN603	1-695-915-11	TAB (CONTACT) (KV-29FV310(S) ONLY)	
C638	1-104-665-11	ELECT	100 $\mu$ F 20% 25V	* CN604	1-695-915-11	TAB (CONTACT) (ALL EXCEPT KV-29FV310(S))	
C640	1-126-942-61	ELECT	1000 $\mu$ F 20% 25V	* CN612	1-580-843-11	PIN, CONNECTOR (POWER)	
C642	1-126-969-11	ELECT	220 $\mu$ F 20% 50V	CN613	1-564-320-00	PIN, CONNECTOR(3.96MM PITCH)	2P
C643	1-136-165-00	FILM	0.1 $\mu$ F 5% 50V	* CN1401	1-564-507-11	PLUG, CONNECTOR	4P
C644	1-126-969-11	ELECT	220 $\mu$ F 20% 50V	* CN1404	1-564-510-11	PLUG, CONNECTOR	7P
C645	1-162-964-11	CERAMIC CHIP	0.001 $\mu$ F 10% 50V	* CN1405	1-564-507-11	PLUG, CONNECTOR	4P
C647	1-126-947-11	ELECT	47 $\mu$ F 20% 35V	* CN1601	1-564-509-11	PLUG, CONNECTOR	6P
C648	1-164-143-11	CERAMIC	0.001 $\mu$ F 10% 1KV	<b>DIODE</b>			
C649	1-164-143-11	CERAMIC	0.001 $\mu$ F 10% 1KV	D501	8-719-404-50	DIODE	MA111-TX
C650	1-100-120-51	ELECT	1000 $\mu$ F 20% 35V	D600	6-500-397-11	DIODE	GBJ4J10B9
C651	1-126-942-61	ELECT	1000 $\mu$ F 20% 25V	D601	8-719-511-40	DIODE	S1VB40
C652	1-165-176-11	CERAMIC CHIP	0.047 $\mu$ F 10% 16V	D608	8-719-110-31	DIODE	MTZJ-T-77-12C
C653	1-126-960-11	ELECT	1 $\mu$ F 20% 50V	D611	8-719-062-40	DIODE	D4SBL20 $\mu$ F3
C656	1-161-964-91	CERAMIC	0.0047 $\mu$ F 250V	D612	8-719-068-00	DIODE (ALL EXCEPT KV-29FV310(S))	ERC04-06SE
C658	1-161-964-91	CERAMIC	0.0047 $\mu$ F 250V	D613	8-719-068-00	DIODE (ALL EXCEPT KV-29FV310(S))	ERC04-06SE
C665	1-126-942-61	ELECT	1000 $\mu$ F 20% 25V	D614	8-719-057-52	DIODE	EZ0150AV1
C667	1-164-625-11	CERAMIC	680pF 10% 500V	D615	8-719-062-40	DIODE	D4SBL20 $\mu$ F3
C668	1-164-625-11	CERAMIC	680pF 10% 500V	D618	8-719-979-64	DIODE	UF4005PKG23
C669	1-164-625-11	CERAMIC	680pF 10% 500V	D619	8-719-404-50	DIODE	MA111-TX
C670	1-164-625-11	CERAMIC	680pF 10% 500V	D620	8-719-404-50	DIODE	MA111-TX
C672	1-165-953-11	FILM	47000pF 3% 800V	D621	6-500-181-01	DIODE	MA6D50
C690	1-126-971-11	ELECT	470 $\mu$ F 20% 50V	D624	8-719-510-12	DIODE	D10SC4M
C1401	1-126-965-91	ELECT	22 $\mu$ F 20% 50V	D625	8-719-510-02	DIODE	D1NS4
C1402	1-162-970-11	CERAMIC CHIP	0.01 $\mu$ F 10% 25V	D628	8-719-404-50	DIODE	MA111-TX
C1403	1-162-970-11	CERAMIC CHIP	0.01 $\mu$ F 10% 25V				
C1404	1-127-715-91	CERAMIC CHIP	0.22 $\mu$ F 10% 16V				
C1405	1-127-715-91	CERAMIC CHIP	0.22 $\mu$ F 10% 16V				



NOTE: The components identified by shading and  $\triangle$  mark are critical for safety. Replace only with part number specified.











NOTE: Les composants identifiés par un trame et une marque  $\triangle$  sont critiques pour la sécurité. Ne les remplacer que par une pièce portant le numéro spécifique.

REF. NO.	PART NO.	DESCRIPTION	VALUES	REF. NO.	PART NO.	DESCRIPTION	VALUES
D629	8-719-110-31	DIODE	RD12ESB2	<b>COIL</b>			
D631	6-500-175-01	DIODE	1E3-TB	L505	1-412-529-81	INDUCTOR	22 $\mu$ H
D632	6-500-175-01	DIODE	1E3-TB	L604	1-412-525-31	INDUCTOR	10 $\mu$ H
D640	8-719-404-50	DIODE	MA111-TX	L605	1-412-519-11	INDUCTOR	3.3 $\mu$ H
D641	8-719-404-50	DIODE	MA111-TX	L606	1-412-519-11	INDUCTOR	3.3 $\mu$ H
D645	6-500-175-01	DIODE	1E3-TB	L607	1-412-525-31	INDUCTOR	10 $\mu$ H
D646	8-719-404-50	DIODE	MA111-TX	L608	1-412-529-81	INDUCTOR	22 $\mu$ H
D647	6-500-175-01	DIODE	1E3-TB	L1400	1-410-470-11	INDUCTOR	10 $\mu$ H
D690	8-719-982-13	DIODE	MTZJ-27	<b>PHOTO COUPLER</b>			
D1400	8-719-991-33	DIODE	1SS133T-77	$\triangle$ PH602	8-749-924-35	PHOTO COUPLER	ON3171-R
D1401	8-719-110-08	DIODE	RD8.2ESB2	<b>IC LINK</b>			
D1402	1-247-807-31	CARBON	100 5% 1/4W	PS601	1-576-337-21	IC LINK	2.7A 50V
<b>FUSE</b>				PS1401	1-576-337-21	IC LINK	2.7A 50V
$\triangle$ F601	1-532-506-51	FUSE	6.3A 250V	<b>TRANSISTOR</b>			
	(KV-29FV310(S) ONLY)			Q509	8-729-423-33	TRANSISTOR	2SC3311A-QRSTA
$\triangle$ F601	1-576-193-11	FUSE	6.3A 125V	Q600	8-729-052-32	TRANSISTOR	IRFIB7N50A-LF31
	(ALL EXCEPT KV-29FV310(S))			Q601	8-729-052-32	TRANSISTOR	IRFIB7N50A-LF31
<b>FERRITE BEAD</b>				Q605	8-729-140-96	TRANSISTOR	2SD774-34
FB602	1-410-397-21	FERRITE	1.1 $\mu$ H	Q606	8-729-422-27	TRANSISTOR	2SD601A-Q
FB604	1-410-397-21	FERRITE	1.1 $\mu$ H	Q608	8-729-922-37	TRANSISTOR	2SD2144S-UVW
FB605	1-410-397-21	FERRITE	1.1 $\mu$ H	Q690	8-729-424-02	TRANSISTOR	2SB709A-QRS-TX
FB609	1-410-397-21	FERRITE	1.1 $\mu$ H	Q691	8-729-026-39	TRANSISTOR	2SA933AS-QT
FB614	1-410-397-21	FERRITE	1.1 $\mu$ H	Q1401	8-729-120-28	TRANSISTOR	2SC1623-L5L6
FB616	1-410-397-21	FERRITE	1.1 $\mu$ H	Q1402	8-729-120-28	TRANSISTOR	2SC1623-L5L6
FB617	1-410-397-21	FERRITE	1.1 $\mu$ H	<b>RESISTOR</b>			
FB650	1-410-397-21	FERRITE	1.1 $\mu$ H	R534	1-216-833-11	METAL CHIP	10K 5% 1/10W
FB651	1-410-397-21	FERRITE	1.1 $\mu$ H	R535	1-216-825-11	METAL CHIP	2.2K 5% 1/10W
FB652	1-410-397-21	FERRITE	1.1 $\mu$ H	R603	1-219-513-11	METAL	4.7M 5% 1/2W
FB653	1-410-397-21	FERRITE	1.1 $\mu$ H		(ALL EXCEPT KV-29FV310(S))		
<b>IC</b>				R604	1-216-833-11	METAL CHIP	10K 5% 1/10W
IC600	8-759-670-30	IC	MCZ3001D	R606	1-216-833-11	METAL CHIP	10K 5% 1/10W
$\triangle$ IC601	8-749-012-13	IC	DM-58	R607	1-216-833-11	METAL CHIP	10K 5% 1/10W
IC605	8-759-450-47	IC	BA05T	R608	1-216-833-11	METAL CHIP	10K 5% 1/10W
IC609	6-702-873-01	IC	NJM2396F09	R609	1-205-998-11	CEMENTED	1 5% 10W
IC1401	6-704-065-01	IC	TFA9844J	R610	1-216-833-11	METAL CHIP	10K 5% 1/10W
IC1402	8-759-689-71	IC	NJM2188M-TE2	R611	1-216-833-11	METAL CHIP	10K 5% 1/10W
<b>CHIP CONDUCTOR</b>				R612	1-260-131-11	CARBON	470K 5% 1/2W
JR6	1-216-864-11	SHORT CHIP		R613	1-216-833-11	METAL CHIP	10K 5% 1/10W
JR10	1-216-864-11	SHORT CHIP		R614	1-216-825-11	METAL CHIP	2.2K 5% 1/10W
<b>JUMPER WIRE</b>				$\triangle$ R615	1-202-933-61	FUSIBLE	0.1 10% 1/2W
JW1456	8-719-991-33	DIODE	1SS133T-77				

NOTE: The components identified by shading and  mark are critical for safety. Replace only with part number specified.

NOTE: Les composants identifiés par un trame et une  sont critiques pour la sécurité. Ne les remplacer que par une pièce portant le numéro spécifique.



REF. NO.	PART NO.	DESCRIPTION	VALUES			REF. NO.	PART NO.	DESCRIPTION	VALUES		
R616	1-216-822-11	METAL CHIP	1.2K	5%	1/10W	R1413	1-216-823-11	METAL CHIP	1.5K	5%	1/10W
R617	1-216-821-11	METAL CHIP	1K	5%	1/10W	R1414	1-216-846-11	METAL CHIP	120K	5%	1/10W
R618	1-216-864-11	SHORT CHIP				R1415	1-216-842-11	METAL CHIP	56K	5%	1/10W
R619	1-249-377-11	CARBON	0.47	5%	1/4W	R1416	1-216-824-11	METAL CHIP	1.8K	5%	1/10W
R620	1-215-857-71	METAL OXIDE	10	5%	1W	R1450	1-249-429-11	CARBON	10K	5%	1/4W
R622	1-249-377-11	CARBON	0.47	5%	1/4W	R1457	1-218-863-11	METAL CHIP	4.7K	0.50%	1/10W
R623	1-249-429-11	CARBON	10K	5%	1/4W	R1458	1-218-863-11	METAL CHIP	4.7K	0.50%	1/10W
R625	1-216-817-11	METAL CHIP	470	5%	1/10W	R1461	1-218-871-11	METAL CHIP	10K	0.50%	1/10W
R626	1-218-869-11	METAL CHIP	8.2K	0.50%	1/10W	R1462	1-218-871-11	METAL CHIP	10K	0.50%	1/10W
R628	1-260-131-11	CARBON	470K	5%	1/2W	R1488	1-216-825-11	METAL CHIP	2.2K	5%	1/10W
R629	1-245-478-21	METAL	470K	1%	1/4W	<b>RELAY</b>					
R630	1-245-478-21	METAL	470K	1%	1/4W	RY501	1-755-198-11	RELAY, AC POWER			
R631	1-218-875-11	METAL CHIP	15K	0.50%	1/10W	 RY600	1-755-395-11	RELAY (AC POWER)			
R632	1-218-823-11	METAL CHIP	100	0.50%	1/10W	<b>TRANSFORMER</b>					
R640	1-249-417-11	CARBON	1K	5%	1/4W	 T601	1-435-617-11	TRANSFORMER, LINE FILTER			
R647	1-211-992-11	METAL CHIP	91	0.50%	1/10W	 T603	1-437-783-11	TRANSFORMER, STANDBY			
R650	1-249-441-11	CARBON	100K	5%	1/4W			(ALL EXCEPT KV-29FV310[S])			
R651	1-249-441-11	CARBON	100K	5%	1/4W	 T603	1-439-854-11	TRANSFORMER, STANDBY			
R658	1-249-393-11	CARBON	10	5%	1/4W			(KV-29FV310(S) ONLY)			
R659	1-249-393-11	CARBON	10	5%	1/4W	 T604	1-437-606-12	COVERTER TRANSFORMER			
R660	1-216-833-11	METAL CHIP	10K	5%	1/10W	<b>THERMISTOR</b>					
R667	1-216-833-11	METAL CHIP	10K	5%	1/10W	THP501	1-803-540-11	THERMISTOR, POSITIVE			
 R668	1-249-413-11	CARBON	470	5%	1/4W			(KV-29FV310(S) ONLY)			
R670	1-216-833-11	METAL CHIP	10K	5%	1/10W	THP501	1-803-970-11	THERMISTOR, POSITIVE			
R671	1-243-979-71	METAL OXIDE	0.1	5%	2W			(ALL EXCEPT KV-29FV310[S])			
R672	1-243-979-71	METAL OXIDE	0.1	5%	2W	<b>VARISTOR</b>					
 R674	1-220-926-11	FUSIBLE	0.47	10%	1/2W	 VDR600	1-803-967-11	VARISTOR			
R687	1-205-998-11	CEMENTED	1	5%	10W			(KV-29FV310(S) ONLY)			
R688	1-205-998-11	CEMENTED	1	5%	10W	 VDR600	1-810-974-21	VARISTOR			
R691	1-216-837-11	METAL CHIP	22K	5%	1/10W			(ALL EXCEPT KV-29FV310[S])			
R692	1-216-837-11	METAL CHIP	22K	5%	1/10W						
R694	1-216-837-11	METAL CHIP	22K	5%	1/10W	*	<b>A-1404-850-A C (VAR) BOARD, MOUNTED</b>				
R698	1-249-377-11	CARBON	0.47	5%	1/4W	*	<b>A-1405-169-A C (VAR) BOARD, MOUNTED</b>				
R699	1-218-265-11	METAL CHIP	8.2M	5%	1W			(KV-29FV310(S) ONLY)			
R1401	1-218-895-11	METAL CHIP	100K	0.50%	1/10W	*	<b>A-1405-222-A C (VAR) BOARD, MOUNTED</b>				
R1403	1-216-864-11	SHORT CHIP						(KV-36FV310 ONLY)			
R1404	1-216-837-11	METAL CHIP	22K	5%	1/10W						
R1405	1-216-841-11	METAL CHIP	47K	5%	1/10W						
R1406	1-218-692-11	METAL CHIP	1K	0.50%	1/10W						
R1408	1-216-823-11	METAL CHIP	1.5K	5%	1/10W						
R1410	1-216-861-11	METAL CHIP	2.2M	5%	1/10W						
R1411	1-216-839-11	METAL CHIP	33K	5%	1/10W						
R1412	1-216-843-11	METAL CHIP	68K	5%	1/10W						
									4-382-854-11	SCREW (M3X10), P, SW (+)	

NOTE: The components identified by shading and  $\triangle$  mark are critical for safety. Replace only with part number specified.

NOTE: Les composants identifiés par un trame et une marque  $\triangle$  sont critiques pour la sécurité. Ne les remplacer que par une pièce portant le numéro spécifique.

C

REF. NO.	PART NO.	DESCRIPTION	VALUES	REF. NO.	PART NO.	DESCRIPTION	VALUES
<b><u>CAPACITOR</u></b>				<b><u>RESISTOR</u></b>			
C701	1-126-947-11	ELECT	47 $\mu$ F 20% 35V	R700	1-249-433-11	CARBON	22K 5% 1/4W
C702	1-136-165-00	FILM	0.1 $\mu$ F 5% 50V	R701	1-216-833-11	METAL CHIP	10K 5% 1/10W
C703	1-126-947-11	ELECT	47 $\mu$ F 20% 35V	R702	1-216-810-11	METAL CHIP	120 5% 1/10W
C704	1-107-652-11	ELECT	10 $\mu$ F 20% 250V	R703	1-216-809-11	METAL CHIP	100 5% 1/10W
C705	1-107-652-11	ELECT	10 $\mu$ F 20% 250V	R704	1-249-422-11	CARBON	2.7K 5% 1/4W
C706	1-137-528-11	MYLAR	0.1 $\mu$ F 10% 250V	R705	1-249-429-11	CARBON	10K 5% 1/4W
C707	1-162-114-00	CERAMIC	0.0047 $\mu$ F 2KV	R706	1-249-381-11	CARBON	1 5% 1/4W
C708	1-104-665-11	ELECT	100 $\mu$ F 20% 25V	R707	1-249-383-11	CARBON	1.5 5% 1/4W
C709	1-126-964-11	ELECT	10 $\mu$ F 20% 50V	R708	1-247-807-31	CARBON	100 5% 1/4W
C710	1-126-964-11	ELECT	10 $\mu$ F 20% 50V	R709	1-247-807-31	CARBON	100 5% 1/4W
C711	1-102-074-00	CERAMIC	0.001 $\mu$ F 10% 50V	R710	1-247-807-31	CARBON	100 5% 1/4W
C713	1-126-964-11	ELECT	10 $\mu$ F 20% 50V	R711	1-260-328-11	CARBON	1K 5% 1/2W
C714	1-126-947-11	ELECT	47 $\mu$ F 20% 35V	R712	1-260-328-11	CARBON	1K 5% 1/2W
<b><u>CONNECTOR</u></b>				R713	1-260-328-11	CARBON	1K 5% 1/2W
* CN701	1-564-506-11	PLUG, CONNECTOR	3P	R714	1-260-087-11	CARBON	100 5% 1/2W
CN702	1-695-915-11	TAB (CONTACT)		R715	1-260-132-11	CARBON	560K 5% 1/2W
CN704	1-785-879-11	CONNECTOR, ONE TOUCH		R716	1-260-123-11	CARBON	100K 5% 1/2W
* CN705	1-564-511-11	PLUG, CONNECTOR	8P	R717	1-216-377-11	METAL OXIDE (KV-32FV310/36FV310 ONLY)	4.7 5% 2W
* CN706	1-564-510-11	PLUG, CONNECTOR	7P	R717	1-216-395-00	METAL OXIDE (KV-27FV310/29FV310 ONLY)	3.3 5% 3W
* CN707	1-508-879-11	BASE POST (KV-36FV310 ONLY)	4P	R718	1-216-372-11	METAL OXIDE (KV-32FV310/36FV310 ONLY)	1.8 5% 2W
<b><u>DIODE</u></b>				R718	1-216-396-11	METAL OXIDE (KV-27FV310/29FV310 ONLY)	3.9 5% 3W
D701	8-719-901-83	DIODE	1SS83	R719	1-215-888-00	METAL OXIDE	220 5% 2W
D702	8-719-901-83	DIODE	1SS83	R720	1-216-825-11	METAL CHIP	2.2K 5% 1/10W
D703	8-719-901-83	DIODE	1SS83	R721	1-216-825-11	METAL CHIP	2.2K 5% 1/10W
D704	8-719-074-25	DIODE	PG104R	R722	1-247-807-31	CARBON	100 5% 1/4W
<b><u>IC</u></b>				R723	1-247-807-31	CARBON	100 5% 1/4W
IC701	8-759-803-42	IC	LA6500-FA	R724	1-247-807-31	CARBON	100 5% 1/4W
IC702	8-759-562-43	IC	TDA6108JF/N1B	R725	1-216-825-11	METAL CHIP	2.2K 5% 1/10W
IC703	8-759-701-59	IC	NJM78M09FA	R726	1-216-829-11	METAL CHIP	4.7K 5% 1/10W
<b><u>JACK</u></b>				R727	1-216-825-11	METAL CHIP	2.2K 5% 1/10W
$\triangle$ J701	1-451-470-21	SOCKET, CRT		<b><u>VARIABLE RESISTOR</u></b>			
<b><u>COIL</u></b>				$\triangle$ RV701	1-241-656-11	RES, ADJ, METAL FILM	110M
L701	1-410-482-31	INDUCTOR	100 $\mu$ H	RV702	1-238-019-11	RES, ADJ, METAL FILM	47K
<b><u>TRANSISTOR</u></b>							
Q700	8-729-422-27	TRANSISTOR	2SD601A-Q				
Q701	8-729-422-27	TRANSISTOR	2SD601A-Q				
Q703	8-729-422-27	TRANSISTOR	2SD601A-Q				

REF. NO.	PART NO.	DESCRIPTION	VALUES	REF. NO.	PART NO.	DESCRIPTION	VALUES
<b><u>ACCESSORIES AND PACKING</u></b>				<b><u>REMOTE COMMANDER</u></b>			
*	4-041-423-01	SHEET, PROTECTION (KV-36FV310 ONLY)		1-476-681-12		REMOTE COMMANDER (RM-Y181)	
				4-978-977-11		BATTERY COVER (for RM-Y181)	
*	4-086-349-04	CARTON, HSC (KV-36FV310 ONLY)					
*	4-085-910-11	CARTON, INDIVIDUAL (KV-32FV310 ONLY)					
*	4-087-224-02	CARTON, INDIVIDUAL (KV-27FV310 ONLY)					
*	4-093-914-01	CARTON, INDIVIDUAL (KV-29FV310 ONLY)					
*	4-085-911-03	CUSHION, FRONT (UPPER) (KV-32FV310 ONLY)					
*	4-086-352-01	CUSHION, FRONT (UPPER) (KV-36FV310 ONLY)					
*	4-087-222-01	CUSHION, UPPER (KV-27FV310/29FV310 ONLY)					
*	4-085-912-02	CUSHION, REAR (UPPER) (KV-32FV310 ONLY)					
*	4-086-353-02	CUSHION, REAR (UPPER) (KV-36FV310 ONLY)					
*	4-085-913-02	CUSHION, LOWER (KV-32FV310 ONLY)					
*	4-086-354-02	CUSHION, LOWER (KV-36FV310 ONLY)					
*	4-087-223-01	CUSHION, LOWER (KV-27FV310/29FV310 ONLY)					
*	4-041-259-05	BAG, PROTECTION (KV-27FV310/29FV310 ONLY)					
*	4-066-845-02	BAG, PROTECTION (KV-32FV310 ONLY)					
*	4-087-598-01	BAG, PROTECTION (KV-36FV310 ONLY)					
	4-093-876-21	MANUAL, INSTRUCTION (KV-27FV310/32FV310/36FV310 ONLY)					
	4-093-876-31	MANUAL, INSTRUCTION (KV-27FV310/32FV310(CND)/36FV310(CND) ONLY)					
	4-093-876-41	MANUAL, INSTRUCTION (KV-29FV310 ONLY)					



# 5-4. SCHEMATICS AND SUPPORTING INFORMATION

## A BOARD SCHEMATIC DIAGRAM

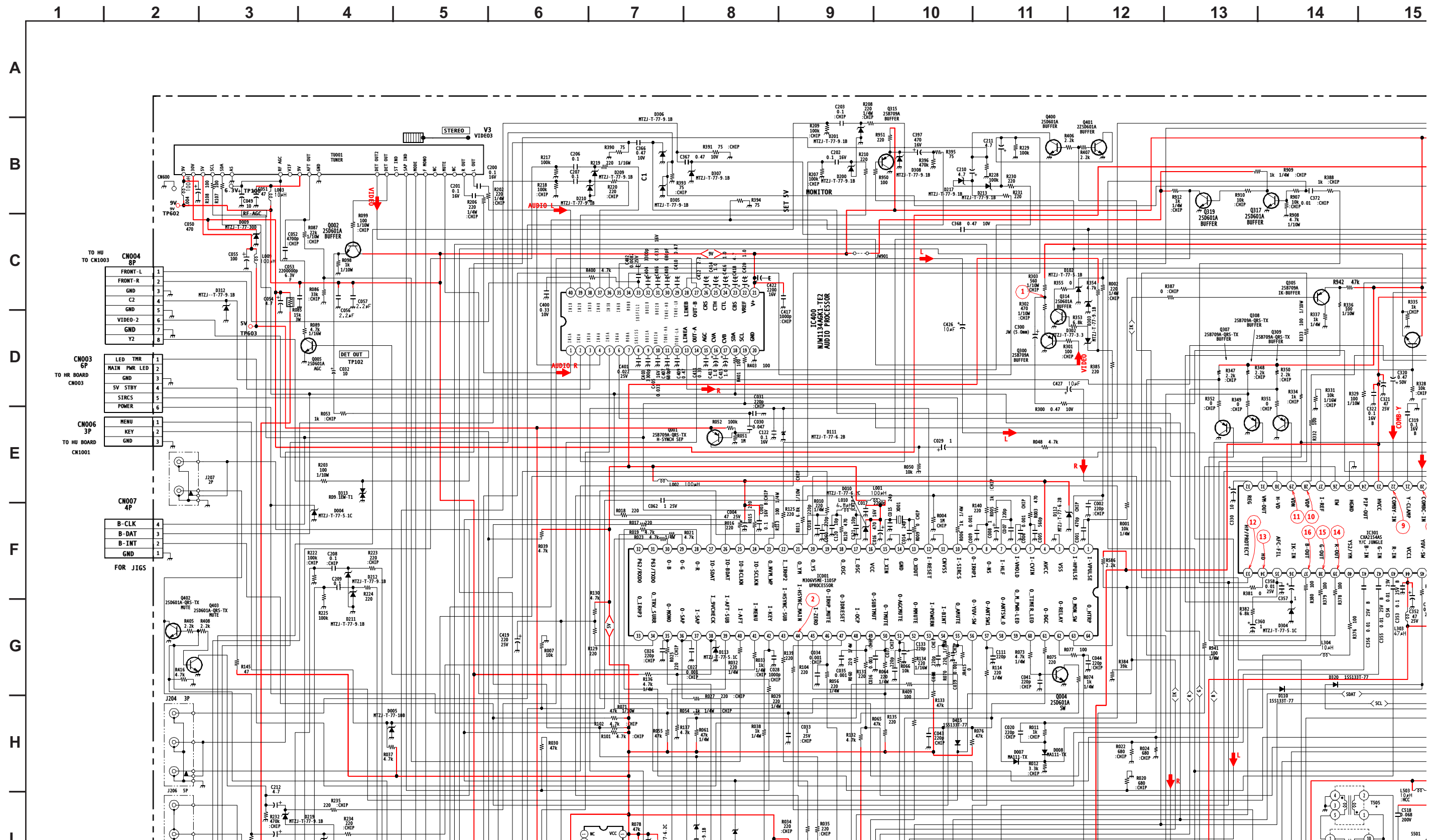

15 | 16 | 17 | 18 | 19 | 20 | 21 | 22 | 23 | 24

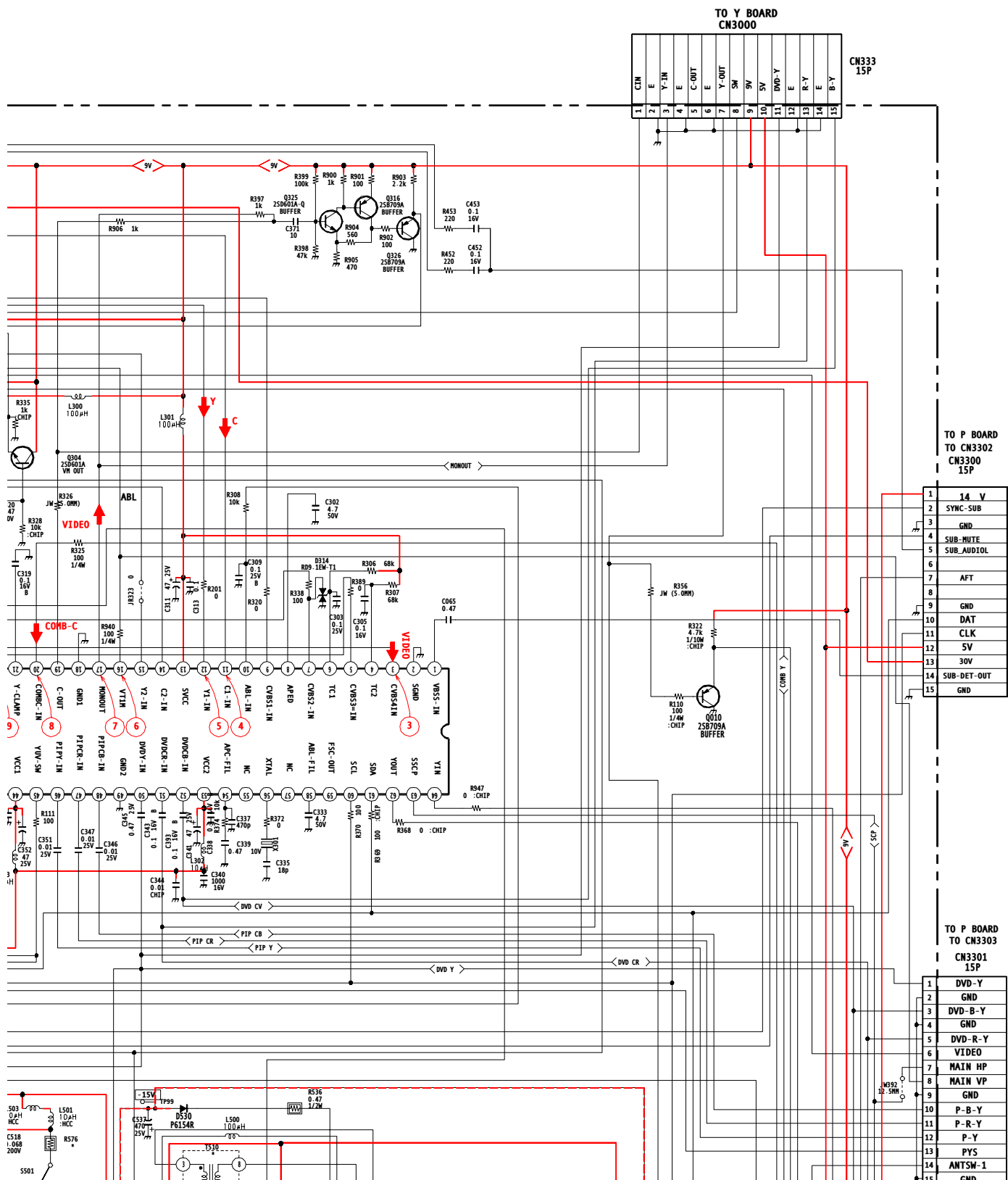

### A BOARD WAVEFORMS

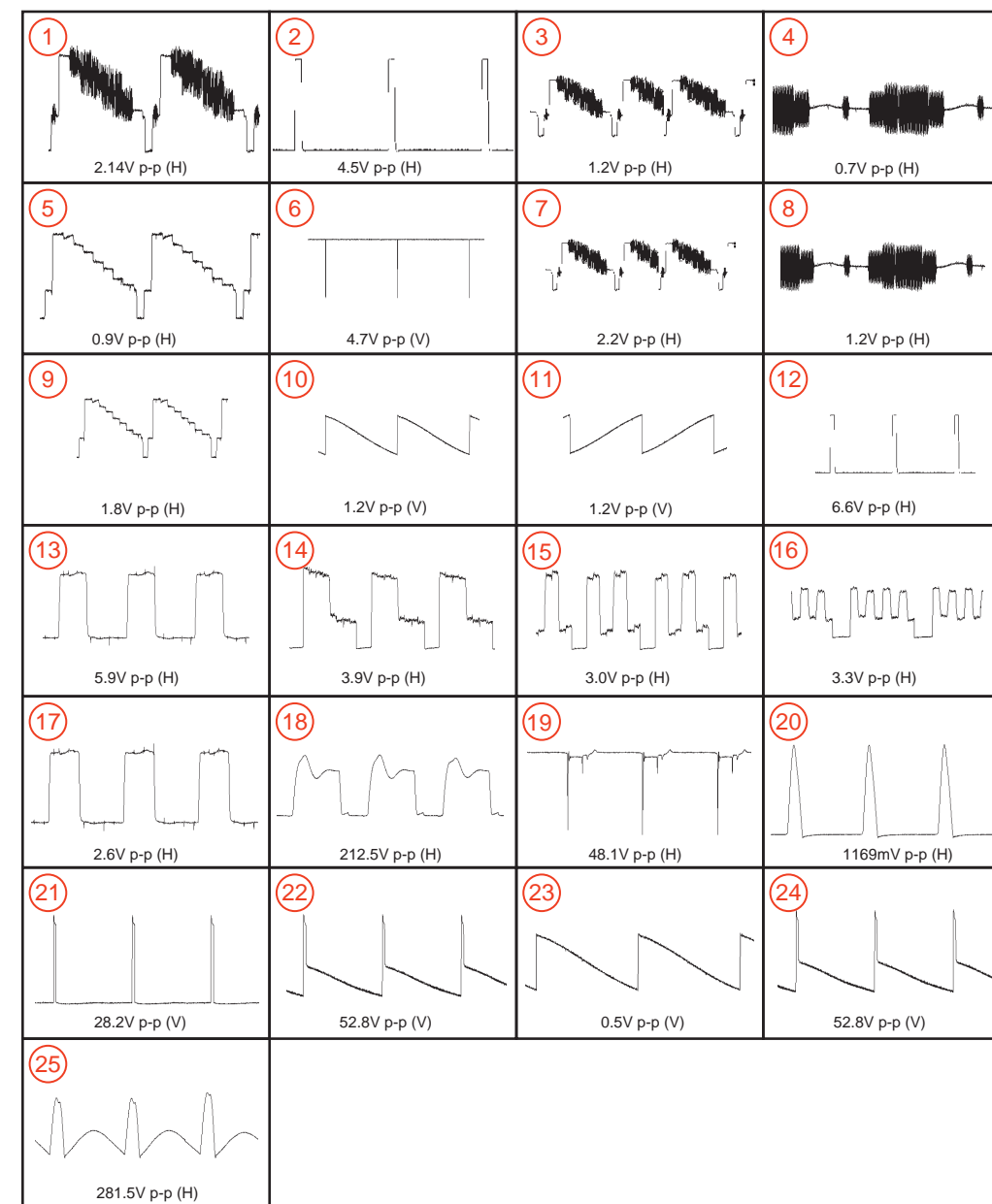

I  
J  
K  
L  
M  
N  
O  
P

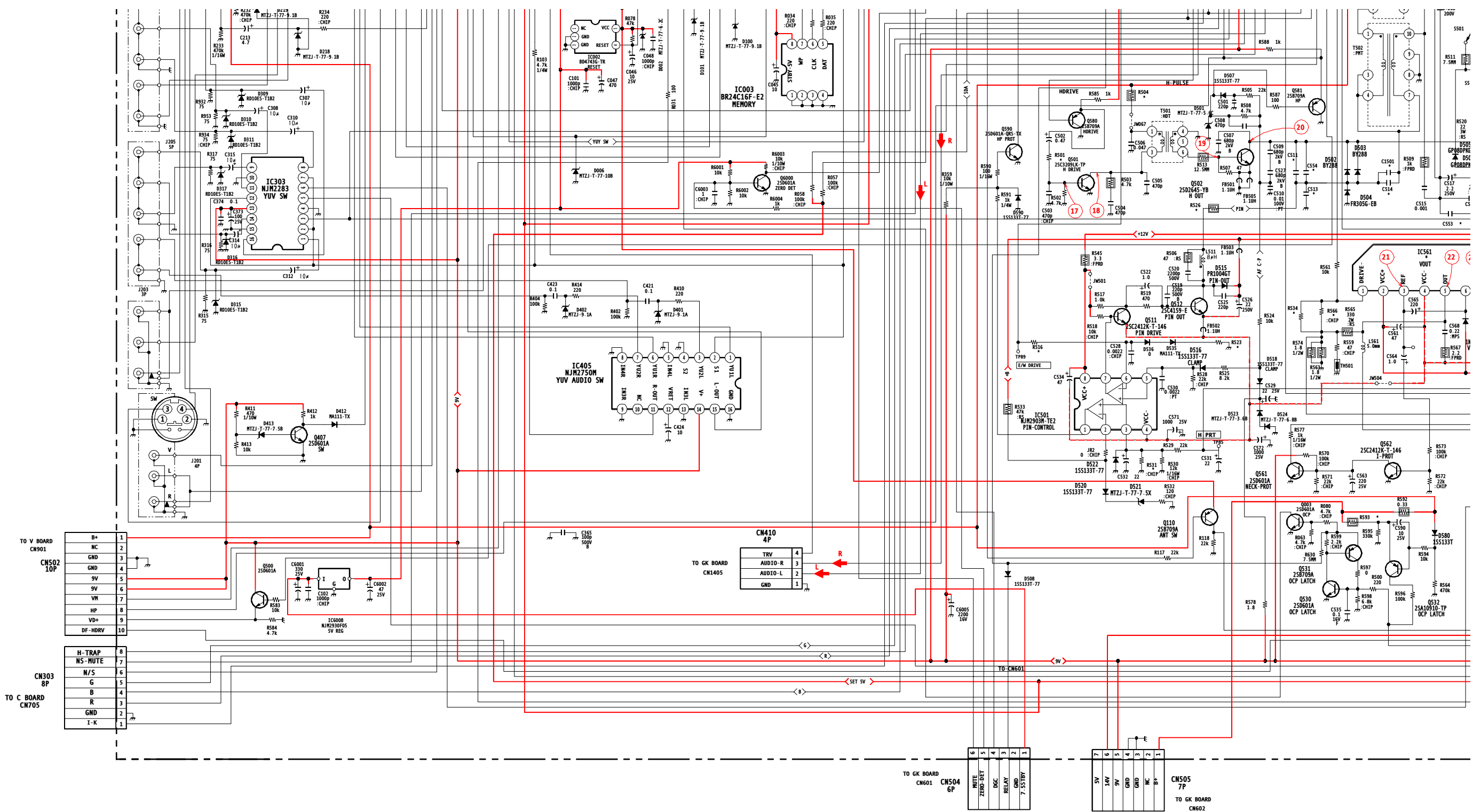

TO V BOARD  
CN502  
10P

B+	1
NC	2
GND	3
9V	4
9V	5
VH	6
HP	7
VD+	8
DF-HDRV	10

TO C BOARD  
CN303  
8P

H-TRAP	8
NS-MUTE	7
N/S	6
G	5
B	4
R	3
GND	2
I-K	1

TO GK BOARD  
CN410  
4P

TRV	4
AUDIO-R	3
AUDIO-L	2
GND	1

TO GK BOARD  
CN601  
6P

WHITE	6
ZERO-DET	5
DC	4
RELAY	3
GND	2
7.5518V	1

TO GK BOARD  
CN505  
7P

9V	7
14V	6
9V	5
GND	4
GND	3
NC	2
9V	1

TO GK BOARD  
CN602



# Y BOARD SCHEMATIC DIAGRAM

Due to the complexity of this board, performing component level field repairs is not recommended. If service is required, complete board replacement is the preferred repair method. Data is provided for reference only.

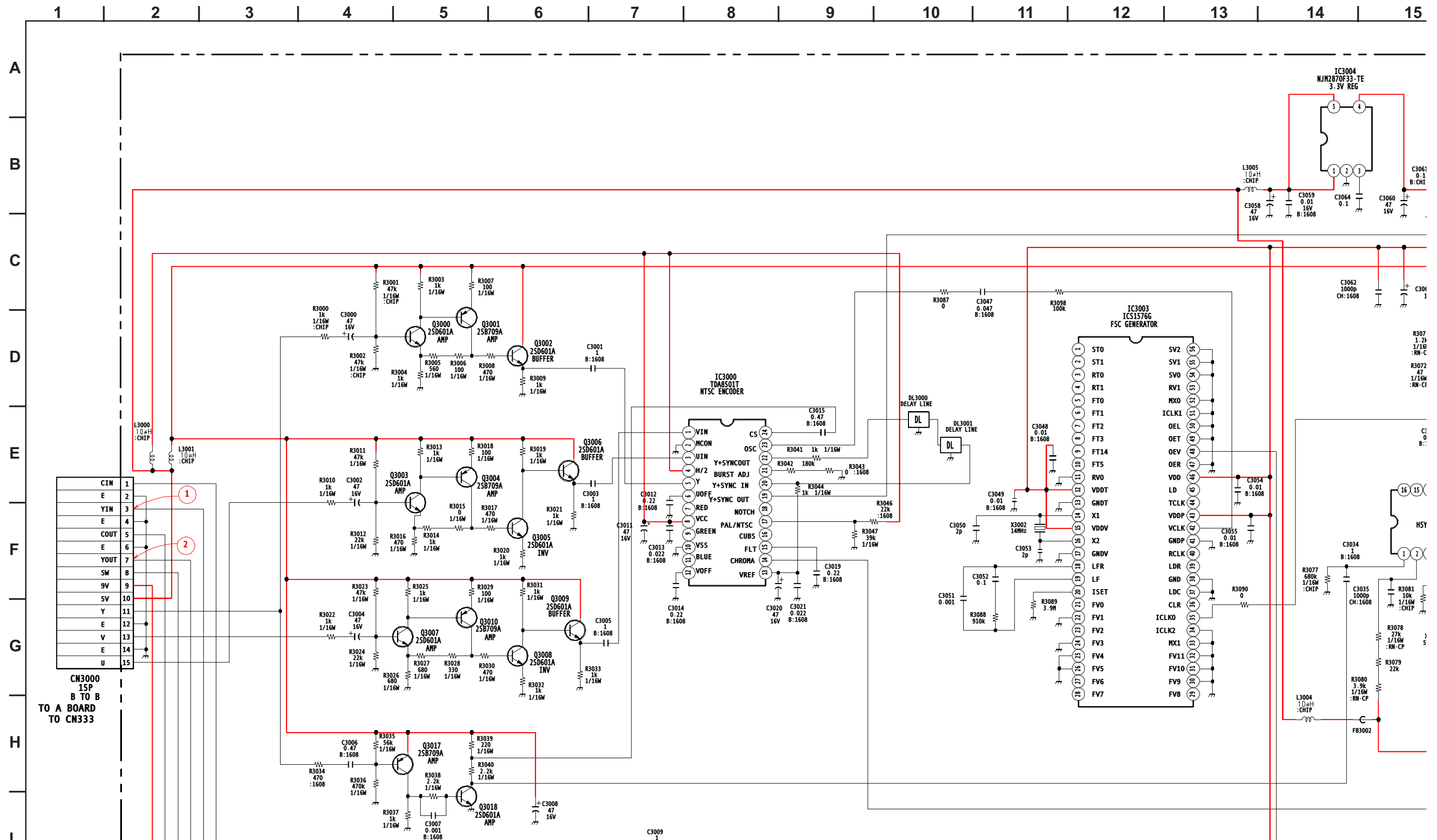

15 | 16 | 17 | 18 | 19 | 20 | 21 | 22 | 23 | 24

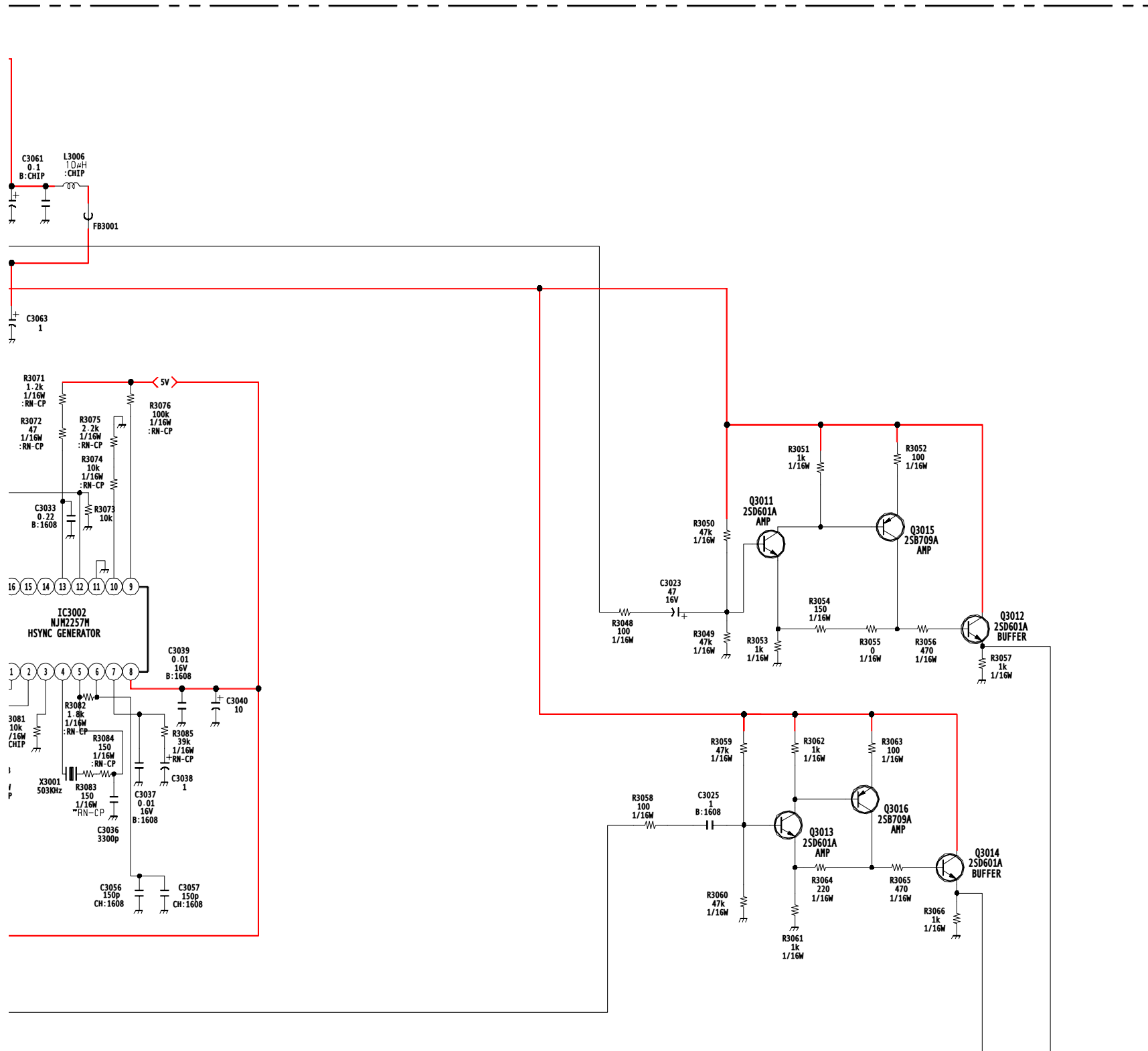

Y BOARD WAVEFORM

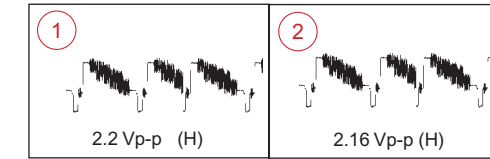

Y COMPONENT SIDE [FSC GEN NTSC ENCODER]

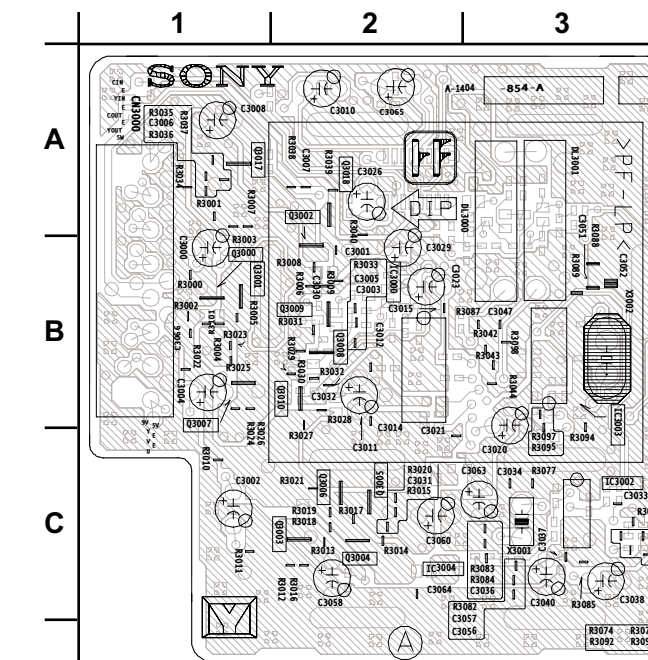



I  
J  
K  
L  
M

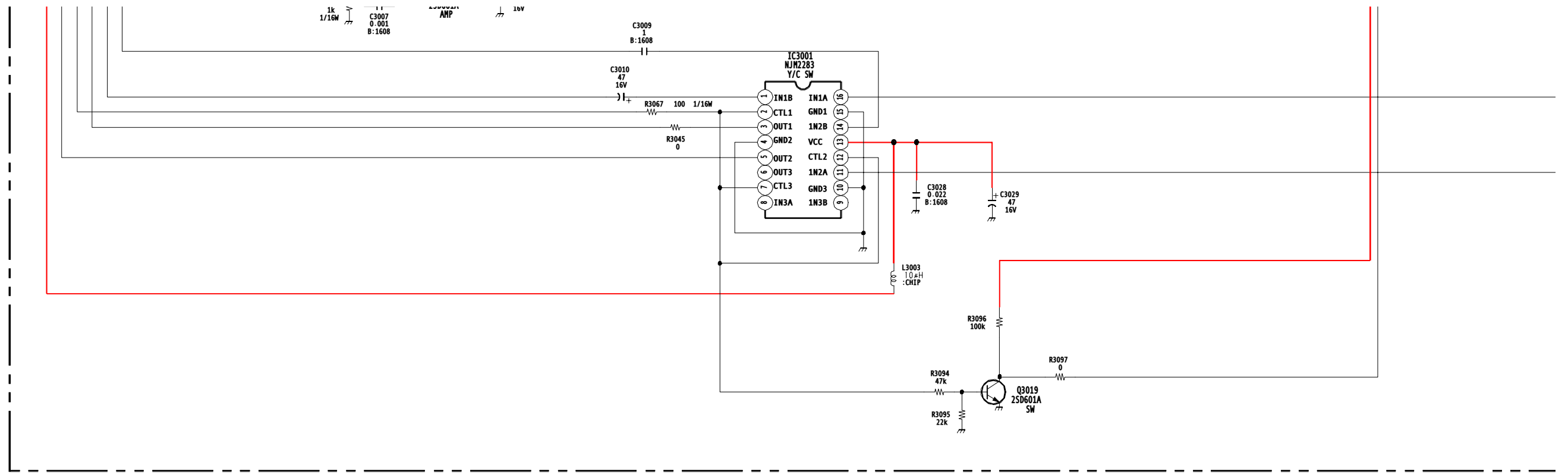

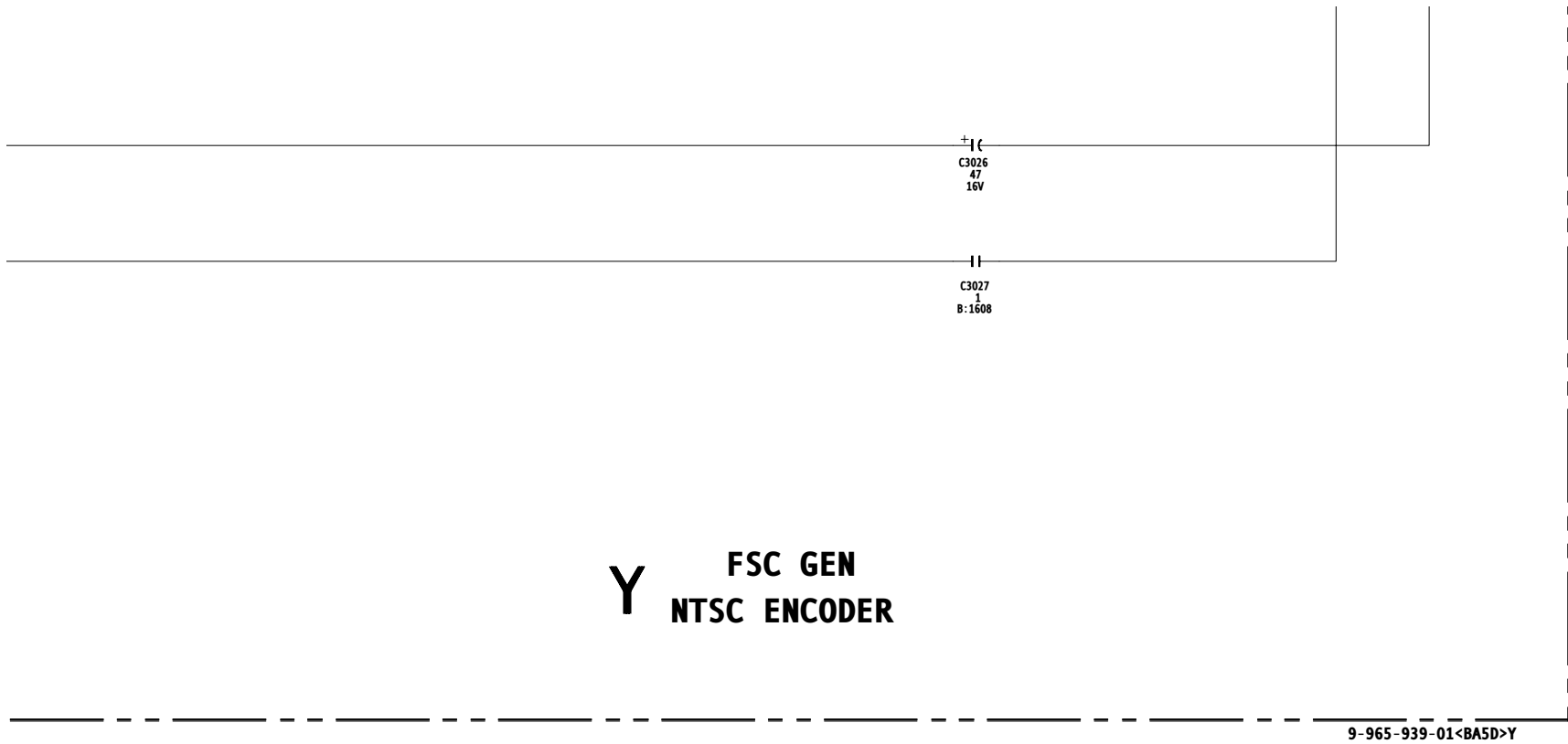

**Y FSC GEN  
NTSC ENCODER**

9-965-939-01<BA5D>Y

**Y CONDUCTOR SIDE [FSC GEN NTSC ENCODER]**

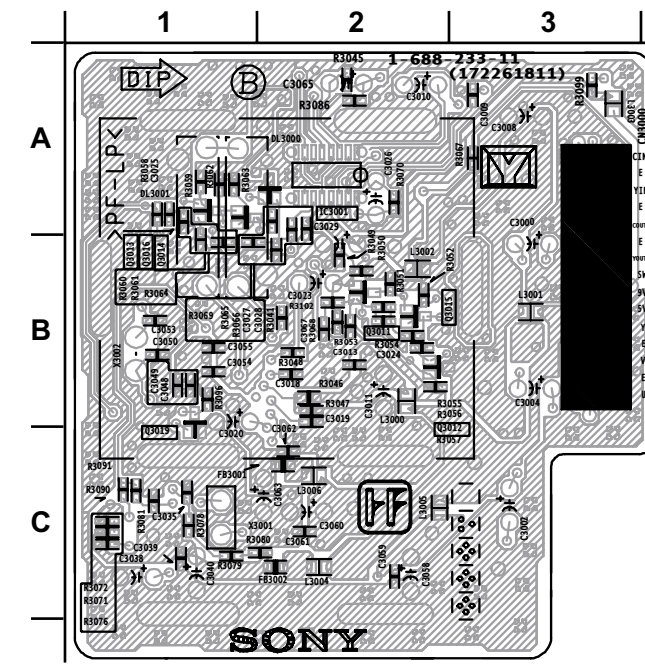

# D BOARD SCHEMATIC DIAGRAM

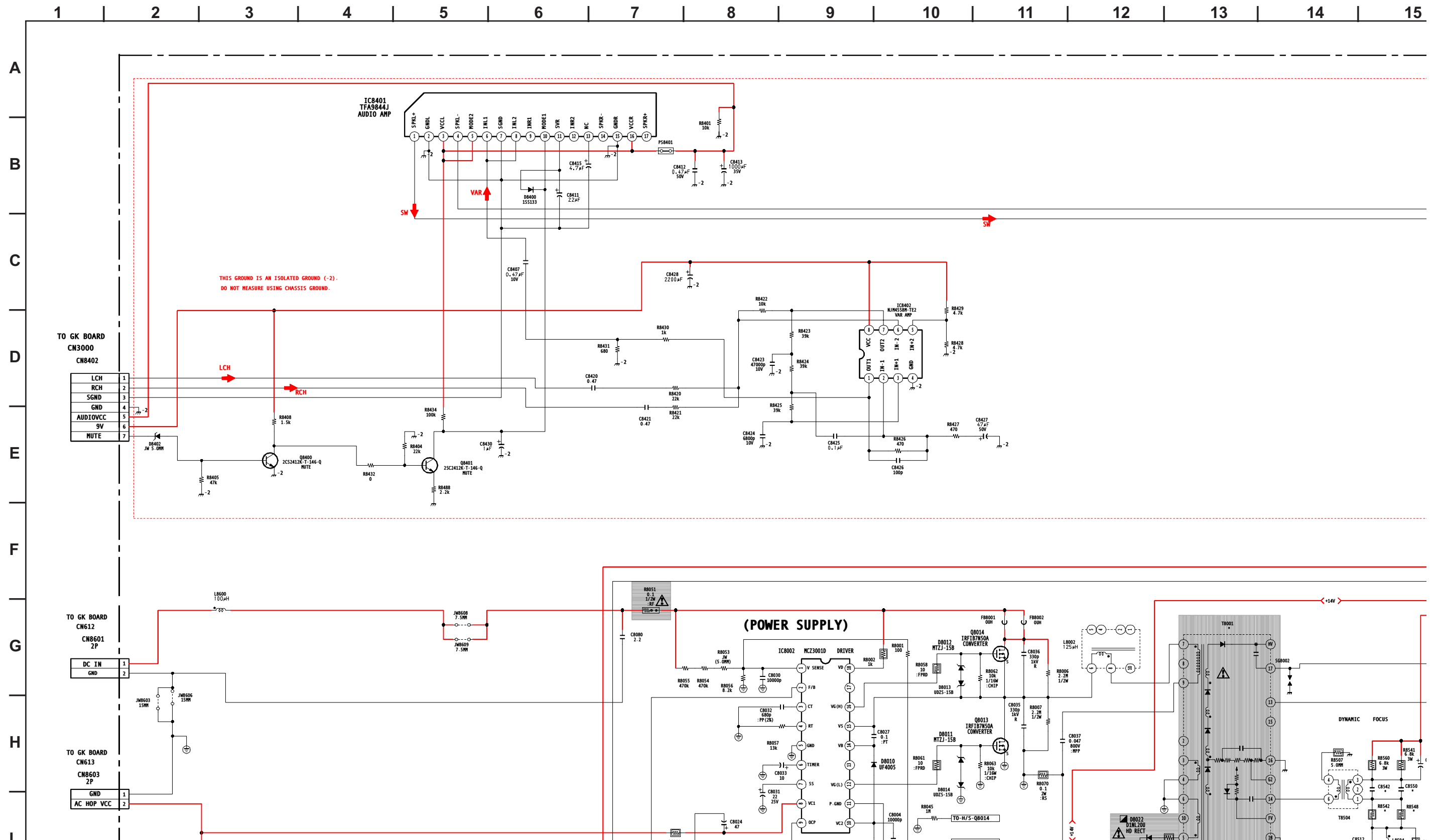

15 | 16 | 17 | 18 | 19 | 20 | 21

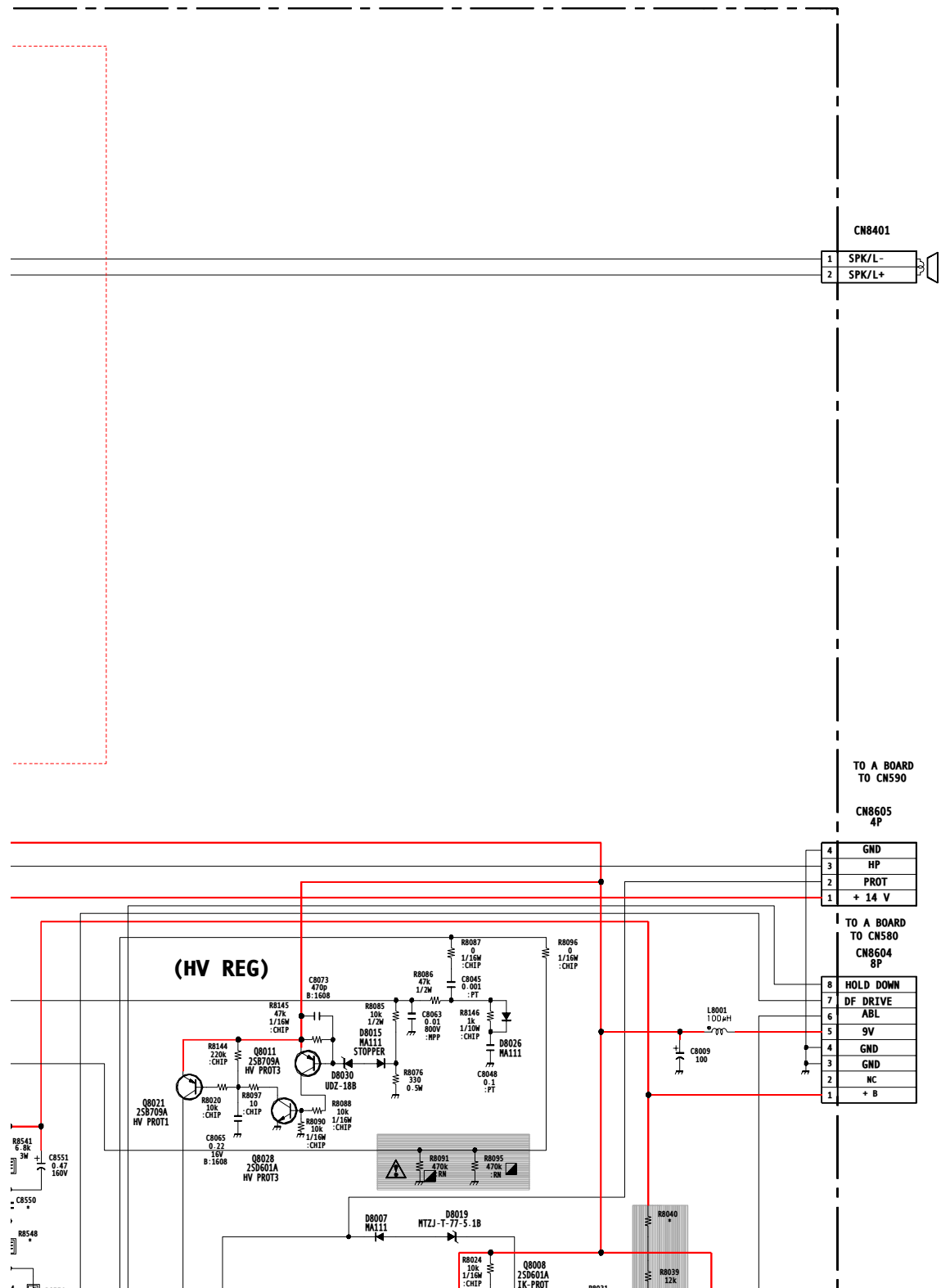

D BOARD IC VOLTAGE LIST

IC8001		IC8004		IC8401	
PIN	VOLT	PIN	VOLT	PIN	VOLT
1	0.0	1	14.0	1	8.3
2	2.5	2	0.9	2	GND
3	2.1	3	0.9	3	19.6
4	GND	4	GND	4	8.3
5	2.3	5	7.1	5	19.6
6	2.5	6	7.1	6	3.2
7	0.0	7	7.1	7	0.0
8	17.5	8	45.2	8	0.0
IC8002		IC8005		9	3.2
PIN	VOLT	PIN	VOLT	10	9.1
1	2.8	1	2.4	11	9.7
2	1.9	2	GND	12	3.2
3	2.3	3	11.0	13	3.3
4	2.6	IC8006		14	8.3
5	GND	PIN	VOLT	15	GND
6	0.0	1	N/C	16	19.6
7	4.6	2	N/C	17	8.3
8	17.5	3	N/C	IC8402	
9	0.0	4	GND	PIN	VOLT
10	10.6	5	2.3	1	4.6
11	0.0	6	2.5	2	4.6
12	4.9	7	0.0	3	4.6
13	2.3	8	14.0	4	GND
14	163.9	IC8104		5	4.6
15	153.8	PIN	VOLT	6	4.6
16	158.2	1	2.5	7	4.6
17	2.6	2	GND	8	9.0
18	314.0	3	2.5		

All voltages are in V.

I  
J  
K  
L  
M  
N

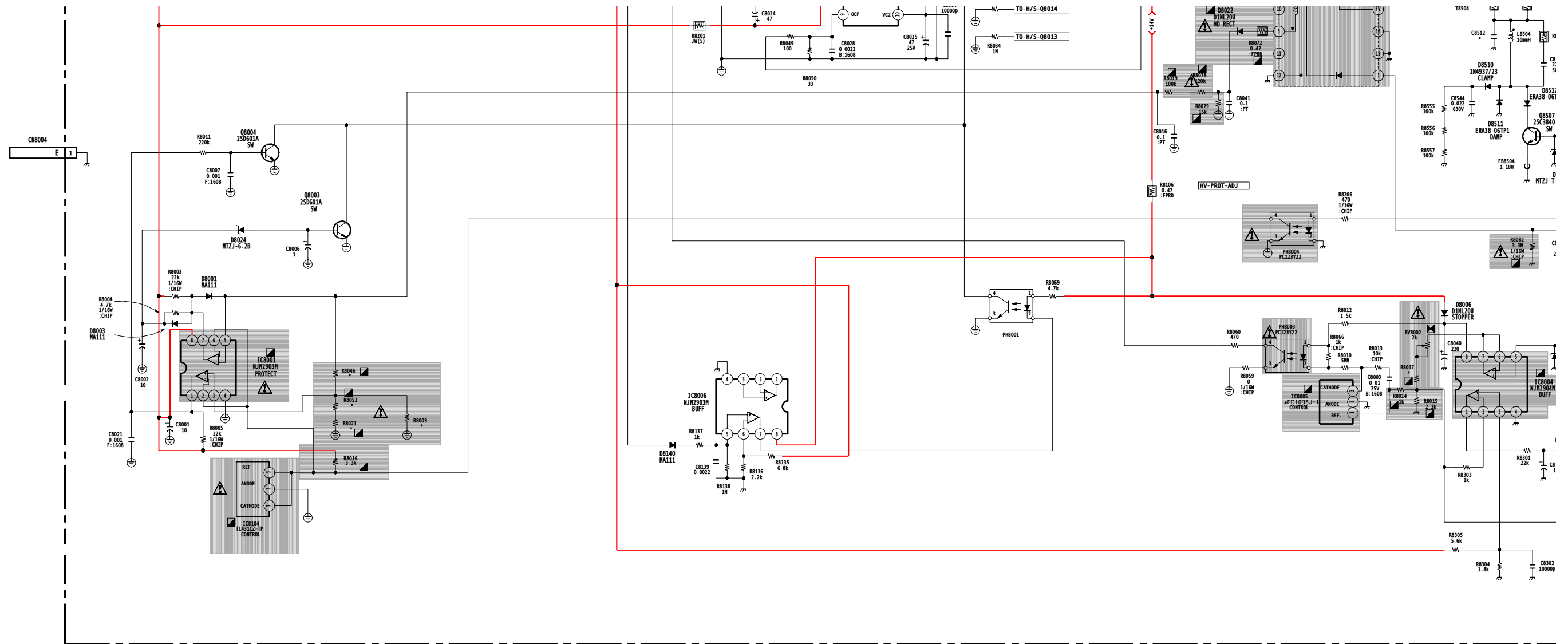

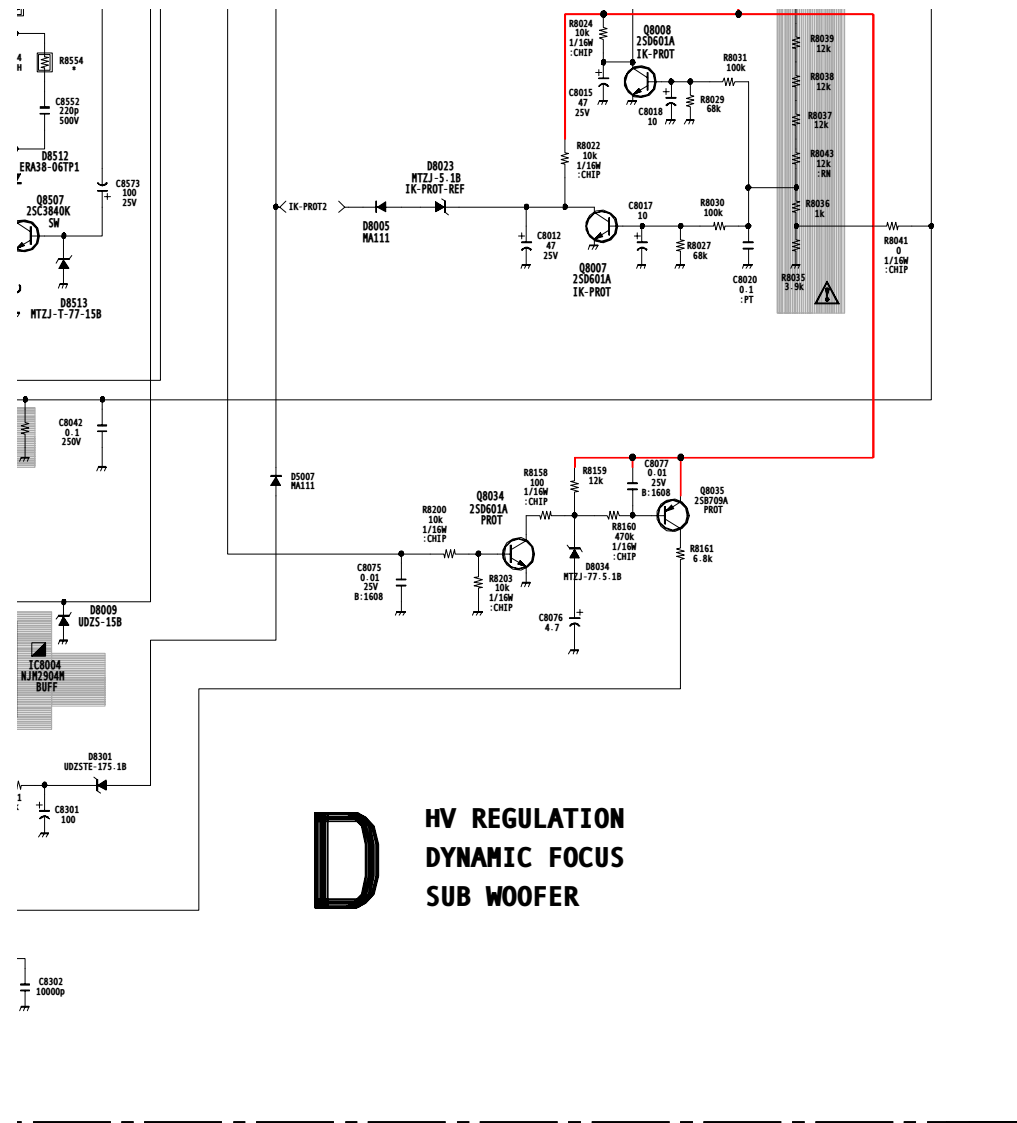

### D BOARD TRANSISTOR VOLTAGE LIST

	B	C	E
Q8003	0.2	2.7	GND
Q8004	0.2	2.7	GND
Q8007	0.0	0.0	GND
Q8008	0.0	0.0	GND
Q8011	9.0	0.0	9.0
Q8021	9.0	0.0	9.0
Q8028	0.0	9.0	GND
Q8034	0.0	9.0	GND
Q8035	9.0	2.5	9.0
Q8400	0.0	0.0	GND
Q8401	0.0	0.0	GND
Q8507	0.0	38.0	GND

	D	G	S
Q8013	155.0	4.3	GND
Q8014	315.0	158.0	156.0

All voltages are in V.



**FD Trinitron**  
**WEGA**®

A stylized graphic consisting of a thick black L-shaped corner on the left and a vertical black bar on the right. The L-shape has a white-to-grey gradient fill. Below the L-shape is a thick black curved line.

**Operating Instructions**

# WARNING

To reduce the risk of fire or electric shock, do not expose the TV to rain or moisture.



This symbol is intended to alert the user to the presence of uninsulated "dangerous voltage" within the product's enclosure that may be of sufficient magnitude to constitute a risk of electric shock to persons.



This symbol is intended to alert the user to the presence of important operating and maintenance (servicing) instructions in the literature accompanying the appliance.

## Note to the CATV Installer

This reminder is provided to call the CATV system installer's attention to Article 820-40 of the NEC that provides guidelines for proper grounding and, in particular, specifies that the cable ground shall be connected to the grounding system of the building as close to the point of cable entry as practical.

## SAFETY PRECAUTIONS

- Operate the TV only on 120 V AC.
- One blade of the power plug is wider than the other for safety purposes and will fit into the power outlet only one way. If you are unable to insert the plug fully into the outlet, contact your dealer.
- If any liquid or solid object falls into the TV, unplug it and have it checked by qualified personnel before operating it further.

## CAUTION

When using TV games, computers, and similar products with your TV, keep the brightness and contrast functions at low settings. If a fixed (non-moving) pattern is left on the screen for long periods of time at a high brightness or contrast setting, the image can be permanently imprinted onto the screen. Continuously watching the same channel can cause the imprint of station logos onto the TV screen. These types of imprints are not covered by your warranty because they are the results of misuse.



To reduce the risk of electric shock, do not use this polarized plug with an extension cord, receptacle, or other outlet unless the blades can be fully inserted to prevent blade exposure.



You are cautioned that any changes or modifications not expressly approved in this manual could void your authority to operate this equipment.

## NOTIFICATION

This equipment has been tested and found to comply with the limits for a Class B digital device pursuant to Part 15 of the FCC Rules. These limits are designed to provide reasonable protection against harmful interference in a residential installation. This equipment generates, uses, and can radiate radio frequency energy and, if not installed and used in accordance with the instructions, may cause harmful interference with radio communications. However, there is no guarantee that interference will not occur in a particular installation. If this equipment does cause harmful interference to radio or television reception, which can be determined by turning the equipment off and on, the user is encouraged to try to correct the interference by one or more of the following measures:

- Reorient or relocate the receiving antennas.
- Increase the separation between the equipment and receiver.
- Connect the equipment into an outlet on a circuit different from that to which the receiver is connected.
- Consult the dealer or an experienced radio/TV technician for help.

## Protecting the TV

- To prevent internal heat build-up, do not block the ventilation openings.
- Do not install the TV in a hot or humid place, or in a place subject to excessive dust or mechanical vibration.

## Note on Caption Vision

This television receiver provides display of television closed captioning in accordance with § 15.119 of the FCC rules. Use of this television for other than private viewing of programs broadcast on UHF or VHF or transmitted by cable companies for the use of the general public may require authorization from the broadcaster-cable company and/or program owner.

## Owner's Record

The model and serial numbers are located on the front cover of this manual and at the rear of your TV.

## Trademarks and Copyrights

ENERGY STAR® is a registered mark.



As an ENERGY STAR® Partner, Sony has determined that this product or product model meets the ENERGY STAR® guidelines for energy efficiency.

WEGA®, FD Trinitron and Caption Vision are registered trademarks of Sony Corporation.  
Licensed by BBE Sound, Inc. under USP 4638258.4482866. BBE and BBE symbol are trademarks of BBE Sound, Inc.

**"WOW, TruSurround, and the (●)® symbol are trademarks of SRS Labs, Inc. WOW technology is incorporated under license from SRS Labs, Inc."**

# IMPORTANT SAFEGUARDS

For your protection, please read these instructions completely, and keep this manual for future reference. Carefully observe and comply with all warnings, cautions and instructions placed on the set, or described in the operating instructions or service manual.

## WARNING

To guard against injury, the following basic safety precautions should be observed in the installation, use, and servicing of the set.

## Use

### Power Sources

This set should be operated only from the type of power source indicated on the serial/model plate. If you are not sure of the type of electrical power supplied to your home, consult your dealer or local power company. For those sets designed to operate from battery power, refer to the operating instructions.



### Grounding or Polarization

This set may be equipped with a polarized alternating current line plug (a plug having one blade wider than other). This plug will fit into the power outlet only one way. This is a safety feature. If you are unable to insert the plug fully into the outlet, try reversing the plug. If the plug still fails to fit, contact your electrician to replace your obsolete outlet. Do not defeat the safety purpose of the polarized plug.

### For the set with a polarized AC power cord plug

This plug will fit into the power outlet only one way. This is a safety feature. If you are unable to insert the plug fully into the outlet, try reversing the plug. If the plug still fails to fit, contact your electrician to have a suitable outlet installed. Do not defeat the safety purpose of the polarized plug by forcing it in.



## Alternate Warning

### For the set with a three-wire grounding type AC plug

This plug will only fit into a grounding-type power outlet. This is a safety feature. If you are unable to insert the plug into the outlet, contact your electrician to have a suitable outlet installed. Do not defeat the safety purpose of the grounding plug.

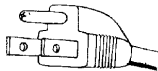

## Overloading

Do not overload wall outlets, extension cords, or convenience receptacles beyond their capacity, since this can result in fire or electric shock.

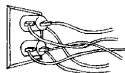

Always turn the set off when it is not to be used. When the set is left unattended and unused for long periods of time, unplug it from the wall outlet as a precaution against the possibility of an internal malfunction that could create a fire hazard.



Do not disconnect the antenna or the power cord during a heavy storm. Lightning may strike while you are holding the cable or cord, causing serious injury. Turn off your TV and wait for the weather to improve.

## Object and Liquid Entry

Never push objects of any kind into the set through the cabinet slots as they may touch dangerous voltage points or short out parts that could result in a fire or electric shock. Never spill liquid of any kind on the set.

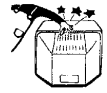

## Attachments

Do not use attachments not recommended by the manufacturer, as they may cause hazards.

Do not place any objects, especially heavy objects, on top of the set. The object may fall from the set, causing injury.



## Cleaning

Unplug the set from the wall outlet before cleaning or polishing it. Do not use liquid cleaners or aerosol cleaners. Use a cloth lightly dampened with water for cleaning the exterior of the set.



If a snapping or popping sound from a TV set is continuous or frequent while the TV is operating, unplug the TV and consult your dealer or service technician. It is normal for some TV sets to make occasional snapping or popping sounds, particularly when being turned on or off.



## Installation

Always use two or more people to lift or move the set. The set is heavy and the bottom surface is flat. Serious injury can result from trying to move the set by yourself alone, or from unsteady handling.

Install the set on a stable, level surface.

## Water and Moisture

Do not use power-line operated sets near water — for example, near a bathtub, washbowl, kitchen sink, or laundry tub, in a wet basement, or near a swimming pool, etc.

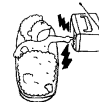

## Accessories

Do not place the set on an unstable cart, stand, tripod, bracket, table, or shelf. The set may fall, causing serious injury to a child or an adult, and serious damage to the set. Use only a cart or stand recommended by the manufacturer for the specific model of TV. Any mounting of the product should follow the manufacturer's instructions, and should use a mounting accessory recommended by the manufacturer. An appliance and cart combination should be moved with care. Quick stops, excessive force, and uneven surfaces may cause the appliance and cart combination to overturn.



## Ventilation

The slots and openings in the cabinet and in the back or bottom are provided for necessary ventilation. To ensure reliable operation of the set, and to protect it from overheating, these slots and openings must never be blocked or covered.

- Never cover the slots and openings with a cloth or other materials.



- Never block the slots and openings by placing the set on a bed, sofa, rug or other similar surface.

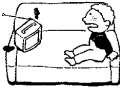

- Never place the set in a confined space, such as a bookcase or built-in cabinet, unless proper ventilation is provided.



- Do not place the set near or over a radiator or heat register, or where it is exposed to direct sunlight.



## Power-Cord Protection

Do not allow anything to rest on or roll over the power cord, and do not place the set where the power cord is subject to wear or abuse.

## Antennas

### Outdoor Antenna Grounding

If an outdoor antenna is installed, follow the precautions below. An outdoor antenna system should not be located in the vicinity of overhead power lines or other electric light or power circuits, or where it can come in contact with such power lines or circuits.

WHEN INSTALLING AN OUTDOOR ANTENNA SYSTEM, EXTREME CARE SHOULD BE TAKEN TO KEEP FROM CONTACTING SUCH POWER LINES OR CIRCUITS AS CONTACT WITH THEM IS ALMOST INVARIABLY FATAL.

Be sure the antenna system is grounded so as to provide some protection against voltage surges and built-up static charges. Section 810 of the National Electrical Code (NEC) in USA and Section 54 of the Canadian Electrical Code in Canada provides information with respect to proper grounding of the mast and supporting structure, grounding of the lead-in wire to an antenna discharge unit, size of grounding conductors, location of antenna discharge unit, connection to grounding electrodes, and requirements for the grounding electrode.

### Antenna Grounding According to the NEC

Antenna Grounding According to the National Electrical Code, ANSI/NFPA 70.

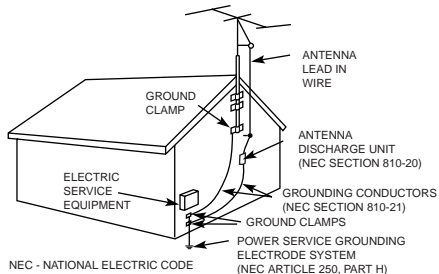

NEC - NATIONAL ELECTRICAL CODE

## Lightning

For added protection for this television receiver during a lightning storm, or when it is left unattended and unused for long periods of time, unplug it from the wall outlet and disconnect the antenna. This will prevent damage to the receiver due to lightning and power-line surges.

## Service

### Damage Requiring Service

Unplug the set from the wall outlet and refer servicing to qualified service personnel under the following conditions:

- When the power cord or plug is damaged or frayed.



- If liquid has been spilled into the set or objects have fallen into the product.



- If the set has been exposed to rain or water.



- If the set has been subject to excessive shock by being dropped, or the cabinet has been damaged.

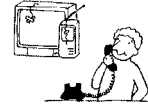

- If the set does not operate normally when following the operating instructions. Adjust only those controls that are specified in the operating instructions. Improper adjustment of other controls may result in damage and will often require extensive work by a qualified technician to restore the set to normal operation.



- When the set exhibits a distinct change in performance — this indicates a need for service.

## Service

Do not attempt to service the set yourself since opening the cabinet may expose you to dangerous voltage or other hazards. Refer all servicing to qualified service personnel.



## Replacement Parts

When replacement parts are required, be sure the service technician certifies in writing that he has used replacement parts specified by the manufacturer that have the same characteristics as the original parts. Unauthorized substitutions may result in fire, electric shock, or other hazards.



## Safety Check

Upon completion of any service or repairs to the set, ask the service technician to perform routine safety checks (as specified by the manufacturer) to determine that the set is in safe operating condition, and to so certify. When the set reaches the end of its useful life, improper disposal could result in a picture tube implosion. Ask a qualified service technician to dispose of the set.



# Contents

## Introduction

Introducing the FD Trinitron WEGA® Features .....	1
About this Manual.....	2
Batteries for the Remote Control .....	2
Front Panel Menu Controls .....	2

## Using the Remote Control

Remote Control Description.....	3
Programming the Remote Control.....	5
Using your Remote Control with Other Equipment .....	7

## Connecting Your TV

TV Rear Panel.....	9
Basic Connections .....	11
Cable Box Connections .....	12
Connecting Additional Equipment.....	14

## Using Basic Functions

Setting Up the TV.....	23
Quick Start to the Menus .....	24
Using Picture in Picture (PIP) .....	26
Connections that affect your ability to use PIP .....	28

## Using the Menus

How to Access Menus.....	29
Using the Video Menu .....	30
Using the Audio Menu .....	31
Using the Channel Menu.....	33
Using the Parent Menu .....	35
Parental Control.....	36
United States: Selecting Custom Rating Options.....	38
Canada: Selecting Custom Rating Options.....	40
Using the Timer Menu .....	41
Using the Setup Menu.....	42
Using the Basic Menu.....	43

## Other Information

Troubleshooting.....	45
Specifications.....	49

<b>Index</b> .....	<b>50</b>
--------------------	-----------

# Introduction

Congratulations on your purchase of the Sony FD Trinitron WEGA®. Before you begin using this manual, please check the model number located on the rear of your TV or on the front cover of this manual.

## Introducing the FD Trinitron WEGA® Features

Some of the features you will enjoy include:

- ❑ **High Voltage Regulator** — Provides a significant improvement to picture quality by increasing the brightness and focus.
- ❑ **FD Trinitron Flat CRT** — Delivers a picture with uncompromising accuracy and outstanding image detail via a technologically advanced tube.
- ❑ **Y, Pb, Pr Inputs** — Provides component video inputs for superior picture quality (480i only).
- ❑ **WOW** — Provides a dramatic presence with a full, deep bass sound. When WOW is enabled, BBE is directly activated to further enhance the audio performance.
- ❑ **TruSurround** — Produces a dynamic three dimensional sound for stereo audio signals.
- ❑ **Parental Control (V-Chip)** — Helps parents monitor what their children watch on TV by establishing rating limits.
- ❑ **ClearEdge VM** — Sharpens picture definition to give objects a crisp, clean edge.
- ❑ **DynaBlack** — Improves contrast and sharpens image detail.
- ❑ **Picture in Picture (PIP)** — Allows you to view two programs simultaneously.
- ❑ **Favorite Channels** — Provides instant access to your favorite channels with the touch of a button.
- ❑ **Info Banner** — Displays the name and the remaining time of the current program viewed, if available.
- ❑ **Universal Remote Control** — Operates your connected cable box, VCR, digital satellite receiver, or DVD player.
- ❑ **Energy Star®** — Meets the Energy Star guidelines for energy efficiency.
- ❑ **Front Panel Controls** — Allows access to the on-screen menus without the use of a remote control.
- ❑ **Front A/V Inputs** — Lets you quickly connect video games, camcorders or stereo/mono equipment.



# About this Manual

This manual provides instructions to help you enjoy your new TV. It shows you how to connect to an antenna or cable, cable box, VCR, DVD, satellite receiver, stereo system, or camcorder. Once your TV is connected, follow the instructions and use the remote control to access the on-screen menus.

# Batteries for the Remote Control

Insert two AA (R6) batteries (supplied) into the remote control using the following illustration as a guide.

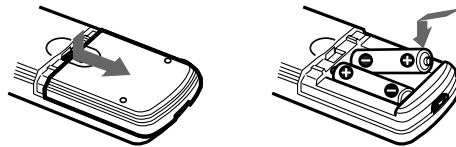

- Under normal conditions, batteries will last up to six months. If the remote control does not operate properly, the batteries might be worn out.
- If you will not be using the remote control for an extended period of time, remove the batteries to avoid possible damage from battery leakage.

# Front Panel Menu Controls

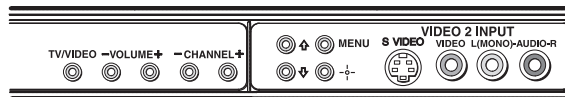

The front Audio/Video panel controls allow you to access the menu without the remote control.



- Press to display the on-screen menu.
- Use the and buttons on the front Audio/Video panel instead of your remote control.
- Use the button on the front Audio/Video panel to navigate through the menus, then select an item. The front panel controls also allow you to change your channels (CH+/-), adjust the volume (VOL +/-), and change video inputs.

To navigate the menus with your remote control, see "Using the Menus" on page 29.

# Using the Remote Control

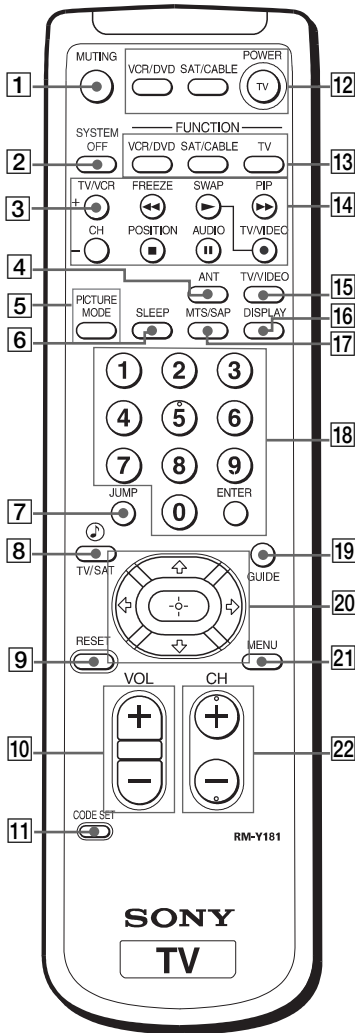
## Remote Control Description



Button	Description
1 <b>MUTING</b>	Press to turn off the sound. Press again or press  to restore sound.
2 <b>SYSTEM OFF</b>	Press to turn off the equipment programmed into the remote control. See "Programming the Remote Control" on page 5.
3 <b>TV/VCR</b>	Press to switch between TV and VCR mode. If you have a non-Sony VCR, you will need to program the remote control to recognize your VCR. For details; see "Programming the Remote Control" on page 5.
4 <b>ANT (antenna)</b>	Press to switch between VHF/UHF input to the AUX input.
5 <b>PICTURE MODE</b>	Press repeatedly to step through the available video picture modes: Vivid, Standard, Movie and Pro. Also available in the Video menu. See "Using the Video Menu" on page 30 for details.
6 <b>SLEEP</b>	Press repeatedly until the TV displays the time in minutes (15, 30, 45, 60, or 90) that you want the TV to remain on before shutting off automatically. Cancel by pressing until Sleep Off appears. While the Sleep feature is set, press once to view the remaining time.
7 <b>JUMP</b>	Press to jump back and forth between two channels. The TV alternates between the current channel and the last channel that you selected. JUMP will not work if any FUNCTION Mode (VCR/DVD, SAT/CABLE, TV) is activated.
8 <b>TV/SAT</b>	Press to switch between the TV and SAT (satellite) inputs when in SAT FUNCTION mode.
	Press for a direct selection of Effect settings (Simulated, WOW, TruSurround, Off) when the remote is in TV FUNCTION mode. See "Using the Audio Menu" on page 31 for details.
9 <b>RESET</b>	Press to return to factory settings while in an on-screen menu.
10 <b>VOL (volume)</b>	Press (+) or (-) to adjust the volume.
11 <b>CODE SET</b>	Press to program your remote control to operate connected video equipment. See "Programming the Remote Control" on page 5.

Button	Description
<b>12 POWER buttons</b>	Press to turn on and off the TV and other audio/video equipment you have programmed into the remote control. For instructions, see "Programming the Remote Control" on page 5.
<b>13 FUNCTION buttons</b>	Press to select the equipment (VCR/DVD, SAT/CABLE, TV) that you want to operate with the remote control. The indicator (LED) lights up momentarily when pressed to show which device the remote control is operating.
<b>14 PIP (Picture in Picture)</b>	Press to operate PIP feature. See "Using Picture in Picture (PIP)" on page 26.
<b>VCR (operating)</b>	Press to operate your VCR. The VCR must be programmed into the remote control. For instructions, see "Programming the Remote Control" on page 5.
<b>● and ► (to record)</b>	Press the ● button and the ► button at the same time to record programs with your VCR. The remote control must be programmed before you can use REC.
<b>◀◀</b>	Rewind.
<b>▶▶</b>	Fast-forward.
<b>▶</b>	Play.
<b>■</b>	Stop.
<b>  </b>	Pause. Press again to resume normal playback.
<b>15 TV/VIDEO</b>	Press to cycle through available video inputs.
<b>16 DISPLAY</b>	Press once to display the current time (if set) and the program status such as channel number, Channel Label (if set), video input, and Video Label (if set). Press again to turn off the display.
<b>17 MTS/SAP</b>	Press to cycle through the Multi-channel TV Sound (MTS) options: Stereo, Auto SAP (Second Audio Programming), and Mono.
<b>18 0-9 and ENTER</b>	Press to change channels. The channel changes after two seconds.
<b>19 GUIDE</b>	Press to display the program guide of your satellite antenna.
<b>20</b>	Press the arrow buttons to move the cursor in the on-screen menus. Press the center button to select an option.
<b>21 MENU</b>	Press to display the on-screen menu. Press again to exit the menu at any time.
<b>22 CH (channel)</b>	Press to change channels. To scan rapidly through the channels, press and hold down the CH+ or CH- button.

 For information on Picture in Picture (PIP) operation buttons, see page 27.



 If you lose your remote control, see page 46.



## Programming the Remote Control

In order to use your remote control with other equipment, you need to program your remote control. Use the following procedure to program the remote control.

- 1 Check the list of “Manufacturer’s Codes” on page 6 and find the three-digit code number for the manufacturer of your component. If more than one code number is listed, use the number listed first.

- 2 Press .

 The  and  button will flash when you press .

- 3 Press  or on the  button bar to indicate the type of component you want to program with the remote control.

 You must do step 4 within 10 seconds of step 3, or you must redo steps 2 and 3.

- 4 Use the  buttons to enter the three-digit manufacturer’s code number.

- 5 Press .

- 6 To check if the code number works, aim the TV’s remote control at the component and press on the green POWER button that corresponds with that component. If it responds, you are done. If not try using another code listed for that manufacturer.

 If you have problems programming your remote control, see “Other Information” on page 45.

## Manufacturer's Codes

### VCRs

<i>Manufacturer</i>	<i>Code</i>
Sony	301, 302, 303
Admiral (M. Ward)	327
Aiwa	338, 344
Audio Dynamic	314, 337
Broksonic	319, 317
Canon	309, 308
Citizen	332
Craig	302, 332
Criterion	315
Curtis Mathes	304, 338, 309
Daewoo	341, 312, 309
DBX	314, 336, 337
Dimensia	304
Emerson	319, 320, 316, 317, 318, 341
Fisher	330, 335
Funai	338
General Electric	329, 304, 309
Go Video	322, 339, 340
Goldstar	332
Hitachi	306, 304, 305, 338
Instant Replay	309, 308
JC Penney	309, 305, 304, 330, 314, 336, 337
JVC	314, 336, 337, 345, 346, 347
Kenwood	314, 336, 332, 337
LXI (Sears)	332, 305, 330, 335, 338
Magnavox	308, 309, 310
Marantz	314, 336, 337
Marta	332
Memorex	309, 335
Minolta	305, 304
Mitsubishi/ MGA	323, 324, 325, 326
Multitech	325, 338, 321
NEC	314, 336, 337

<i>Manufacturer</i>	<i>Code</i>
Olympic	309, 308
Optimus	327
Panasonic	308, 309, 306, 307
Pentax	305, 304
Philco	308, 309
Philips	308, 309, 310
Pioneer	308
Quasar	308, 309, 306
RCA/ PROSCAN	304, 305, 308, 309, 311, 312, 313, 310, 329
Realistic	309, 330, 328, 335, 324, 338
Sansui	314
Samsung	322, 313, 321
Sanyo	330, 335
Scott	312, 313, 321, 335, 323, 324, 325, 326
Sharp	327, 328
Shintom	315
Signature 2000 (M. Ward)	338, 327
SV2000	338
Sylvania	308, 309, 338, 310
Symphonic	338
Tashiro	332
Tatung	314, 336, 337
Teac	314, 336, 338, 337
Technics	309, 308
Toshiba	312, 311
Wards	327, 328, 335, 331, 332
Yamaha	314, 330, 336, 337
Zenith	331

### Laserdisc Players

<i>Manufacturer</i>	<i>Code</i>
Sony	701
Panasonic	704, 710
Pioneer	702

### DVD Players

<i>Manufacturer</i>	<i>Code</i>
Sony	751
Hitachi	758
JVC	756
Magnavox	757
Mitsubishi	761
Oritron	759
Panasonic	753
Philips	757
Pioneer	752
RCA	755
Samsung	758
Toshiba	754
Zenith	760

### Cable Boxes









<i>Manufacturer</i>	<i>Code</i>
Sony	230
Hamlin/Regal	222, 223, 224, 225, 226
Jerrold/G.I./ Motorola	201, 202, 203, 204, 205, 206, 207, 208, 218
Oak	227, 228, 229
Panasonic	219, 220, 221
Pioneer	214, 215
Scientific Altanta	209, 210, 211
Tocom	216, 217
Zenith	212, 213

### Satellite Receivers



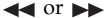





<i>Manufacturer</i>	<i>Code</i>
Sony	801
Dish Network	810
Echostar	810
General Electric	802
Hitachi	805
Hughes	804
Mitsubishi	809
Panasonic	803
RCA/ PROSCAN	802, 808
Toshiba	806, 807

## Using your TV Remote Control with Other Equipment





### Operating a VCR

Press	To
	Power on the VCR (VCR/DVD green button)
	Select a channel
	Change channels
	Play video tape
	Stop
	Search forward or backward
	Pause
	Record
	Switch between VCR and TV inputs

### Operating a DVD Player









Press	To
	Power on the DVD (VCR/DVD green button)
	Select chapters
	Search chapters forward or backward
	Play DVD
	Stop
	Pause
	Display the DVD menu
	Use the arrow buttons to move the cursor in the menu, and the center button to select an option

### Operating a Laser Disc Player





Press	To
	Power on the laser disc (VCR/DVD green button)
	Search chapters forward or backward
	Play disc
	Stop
	Pause



### Operating a Satellite Receiver

Press	To
	Power on the satellite receiver (SAT/CABLE green button)
	Select a channel
	Change channels
	Back to previous channel
	Display channel number
	Display SAT GUIDE
	Display SAT Menu
	Use the arrow buttons to move the cursor in the menu, and the center button to select an option

### Operating a Cable Box

Press	To
	Power on the cable box (SAT/CABLE green button)
	Select a channel
	Change channels
	Change back to previous channel

# Connecting Your TV

Read this section before setting up your TV for the first time. This section explains how to make the basic connections and how to connect optional equipment.

## TV Rear Panel

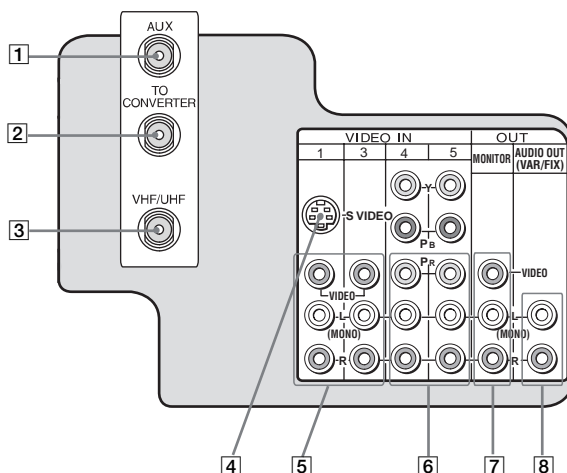

Jack	Description
<b>1 AUX</b>	This input allows you to view local and cable channels if your cable provider does not feature local channels. You can switch between local and cable channels by pressing ANT on the remote control. Devices connected to the AUX input cannot be viewed in PIP.
<b>2 TO CONVERTER</b>	This is a VHF/UHF out jack that lets you set up your TV to switch between scrambled channels (through a cable box) and normal cable channels (CATV). Use this jack instead of a splitter to get better picture quality when you need to switch between scrambled and unscrambled cable channels.
<b>3 VHF/UHF</b>	This input connects to your VHF/UHF antenna or cable.
<b>4 S VIDEO</b>	This input connects to the S VIDEO OUT jack on your VCR or other video equipment that has S VIDEO. S VIDEO provides better picture quality than the VHF/UHF jacks or the video input jack. S VIDEO does not provide sound, so you still must connect the audio cables.

Jack	Description
<b>5 AUDIO L(MONO), R/ VIDEO</b>	This input connects to the AUDIO/VIDEO output jacks on your VCR or other video equipment. A third video input jack (VIDEO 2) is located on the front panel of the TV. These AUDIO/VIDEO input jacks provide better picture quality than the VHF/UHF jack.
<b>6 Y, P<sub>B</sub>, P<sub>R</sub>/ L(MONO), R</b>	These inputs (Video 4-5) connect to the component video Y, P <sub>B</sub> , P <sub>R</sub> , and AUDIO L(MONO), R jacks on your DVD player or digital set-top box (480i only).
<b>7 MONITOR OUT</b>	This output lets you record the program you are watching to a VCR. When two VCRs are connected (see "Connecting Two VCRs for Tape Editing" on page 21), you can use your TV as a monitor for tape-to-tape editing.
<b>8 AUDIO OUT (VAR/FIX) L(MONO), R</b>	This jack connects to the Audio input jacks on your audio equipment. You can listen to your TV's audio through your stereo system.

## Basic Connections

### TV with Cable, Indoor, or Outdoor Antenna

Depending on the cable system available in your home, choose one of the connections below:

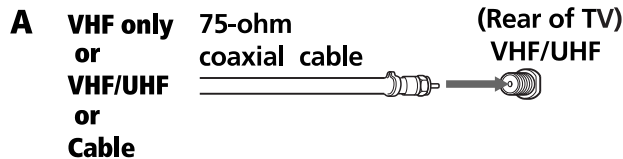

Use this to connect the TV to a cable system or an antenna with a 75-ohm cable (usually built in to newer homes).

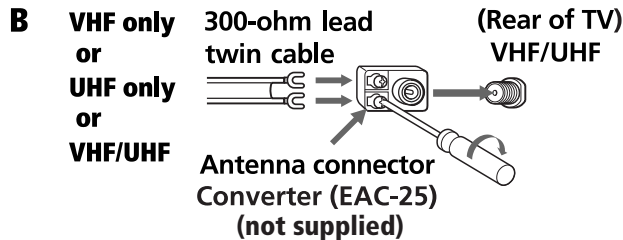

Use this to connect the TV to a dipole antenna, also known as a “rabbit ears antenna” (usually found in older homes).

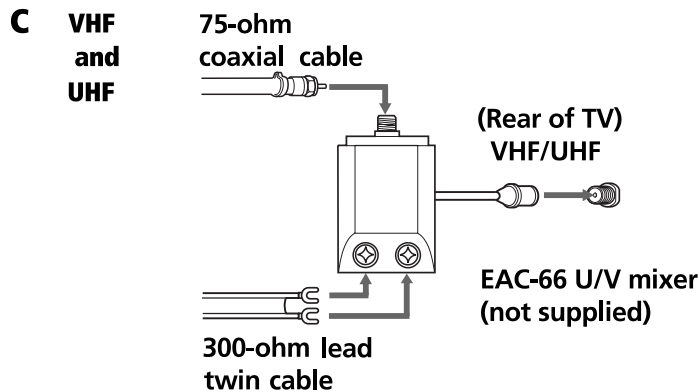

This allows you to connect your TV to both a cable system and a dipole antenna, in order to view both cable and local channels.

 If you are connecting to an indoor or outdoor antenna, you may need to adjust the orientation of the antenna for the best reception.

## Cable Box Connections

Some cable TV systems use scrambled or encoded signals that require a cable box to view all channels. If you subscribe to that kind of cable service, use this connection. Scrambled signals coming in to the TV through the cable box cannot be viewed in PIP. If some, but not all, of your channels are scrambled, consider using the cable box and cable connection.

### TV and Cable Box

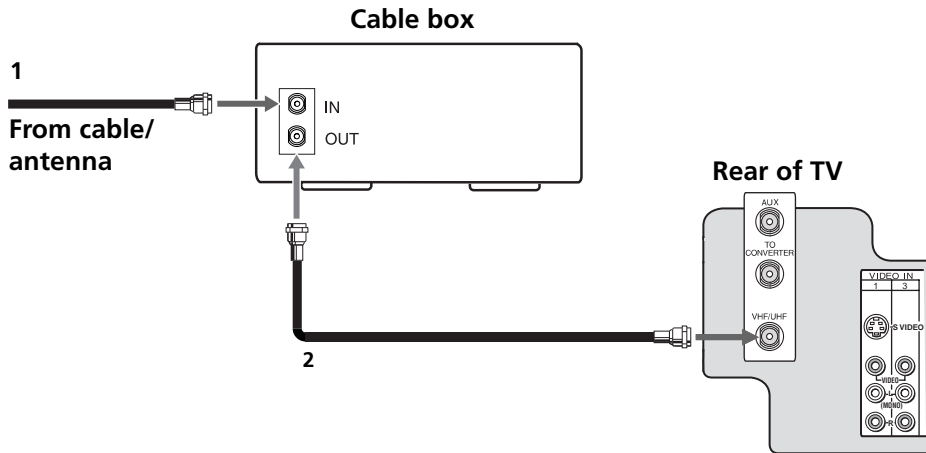

- 1** Connect the coaxial cable from your cable service to the IN jack on your cable box.
- 2** Connect a coaxial cable (not supplied) from the OUT jack on your cable box to the VHF/UHF jack on your TV.

### Using your TV with this connection

This connection allows you to do the following:

- ❑ Program your Sony remote control to operate your cable box (see page 5).
- ❑ To activate your remote press  to operate your cable box and then use the **0-9** buttons or CH+/- buttons to change the channels. To do this, first program your remote control, then use the Channel Fix feature to set your TV to channel 3 or 4 (see page 33).

## Cable Box and Cable

Use this connection if you subscribe to a cable system that scrambles some channels (pay channels) but not all of them. This setup allows you to use the remote control to:

- ❑ change channels through your cable box when you are receiving a scrambled signal
- ❑ change channels through your TV

This connection also allows you to use the PIP feature when you are viewing unscrambled channels coming directly into your TV from your cable. Scrambled signals coming through the cable box cannot be viewed in PIP. For more information on the PIP feature, see page 26.

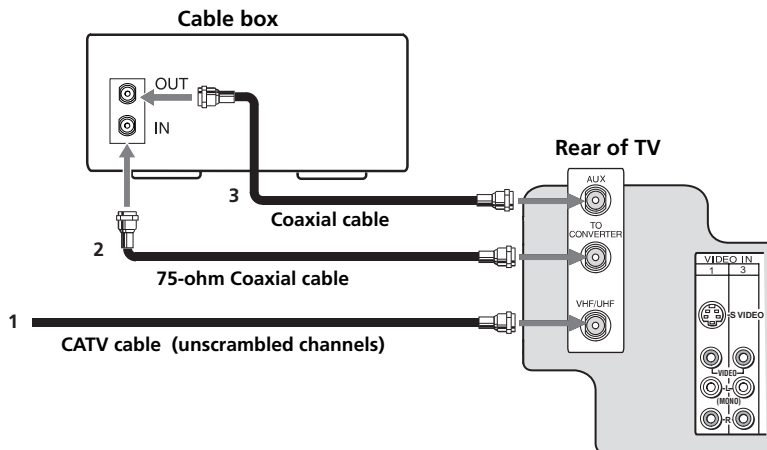

 **DIGITAL CABLE BOX USERS:** Do not use this connection. The TO CONVERTER jack is not compatible with digital boxes.



- 1** Connect the coaxial cable from your cable service to the VHF/UHF jack on your TV.
- 2** Using a coaxial cable (not supplied), connect the IN jack on your cable box to the TO CONVERTER jack on your TV.
- 3** Using a coaxial cable (not supplied), connect the OUT jack on your cable box to the AUX jack on your TV.

### Using your TV with this connection

This connection allows you to do the following:

- ❑ Program your Sony remote control to operate your cable box (see page 5).
- ❑ To activate your remote, press  to operate your cable box and then use the 0-9 buttons or CH+/- buttons to change the channels. To do this, first program your remote control, then use the Channel Fix feature to set your TV to channel 3 or 4 (see page 33).
- ❑ Press  to switch back and forth between VHF/UHF (local channels or unscrambled) and AUX (cable system or pay channels).



## Connecting Additional Equipment

### Connecting a TV and VCR

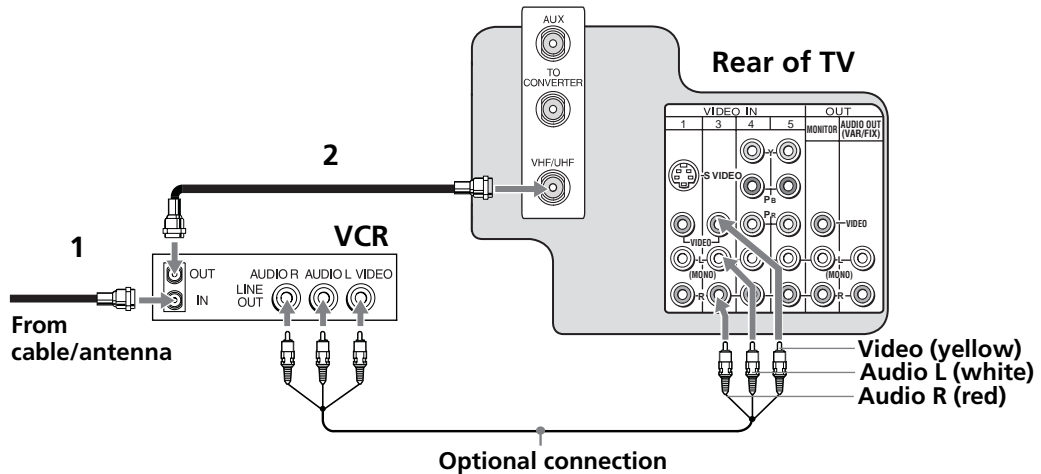



- 1** Connect the coaxial cable from your TV antenna or cable service to the IN jack on your VCR.
- 2** Connect a coaxial cable (not supplied) from the OUT jack on your VCR to the VHF/UHF jack on the TV.

#### Optional connection

- ❑ If your VCR is equipped with video outputs, you can get better picture quality by connecting audio/video cables (not supplied) from AUDIO/VIDEO OUT on your VCR to AUDIO/VIDEO IN on your TV.
- ❑ For better picture quality, use S VIDEO instead of the yellow video cable. S VIDEO does not provide sound, so you still must connect the audio cables.

#### Using your TV with this connection

This connection allows you to do the following:

- ❑ Program your Sony remote control to operate your VCR (see page 5).
- ❑ To activate your remote, press  to operate your VCR. To do this, first program your remote control, then use the Channel Fix feature to set your TV to channel 3 or 4 (see page 33).
- ❑ Press  repeatedly to switch between VCR input (VIDEO input) and VHF/UHF (local channels).

## Connecting a TV, VCR, and Cable Box

Use this connection if you subscribe to a cable system that scrambles some channels (pay channels), but not all of them. This setup allows you to use the remote control to:

- ❑ change channels through your cable box or VCR when you are receiving a scrambled signal
- ❑ change channels through your TV

This connection also allows you to use the PIP feature when you are viewing unscrambled channels coming directly into your TV from your cable. Scrambled signals coming through the cable box cannot be viewed in PIP. For more information on the PIP feature, see page 26.

 **DIGITAL CABLE BOX USERS:** If you are connecting a digital cable box, you will need a special bi-directional splitter that is designed to work with your digital cable box. Contact your cable provider for details.

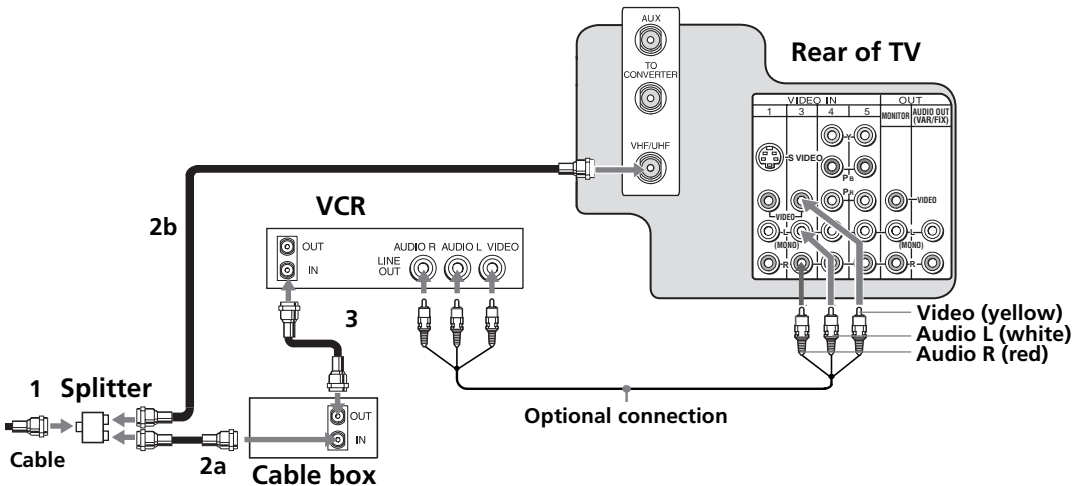

- 1** Connect the single input jack of the splitter to your incoming cable connection.
- 2** Using coaxial cables (not supplied), connect the two output jacks of the splitter to:
  - a)** the IN jack on your cable box
  - b)** the VHF/UHF jack on the TV
- 3** Using a coaxial cable (not supplied), connect the OUT jack on your cable box to the IN jack on your VCR.



(continued)

 DIGITAL CABLE BOX USERS: Do not use this connection. The TO CONVERTER jack is not compatible with digital boxes.

### Optional connection

- ❑ If your VCR is equipped with video outputs, you can get better picture quality by connecting audio/video cables (not supplied) from AUDIO/VIDEO OUT on your VCR to AUDIO/VIDEO IN on your TV.
- ❑ For better picture quality, use S VIDEO instead of the yellow video cable. S VIDEO does not provide sound, so you still must connect the audio cables.

### Using your TV with this connection

- ❑ Program your Sony remote control to operate your VCR or cable box (see page 5).
- ❑ To activate your remote, press  to operate your VCR or  to operate your cable box. To do this, first program your remote control, then use the Channel Fix feature to set your TV to channel 3 or 4 (see page 33).
- ❑ Press  repeatedly to switch between VCR input (VIDEO input), VHF/UHF (local channels or unscrambled), or cable box (cable system or scrambled channels).

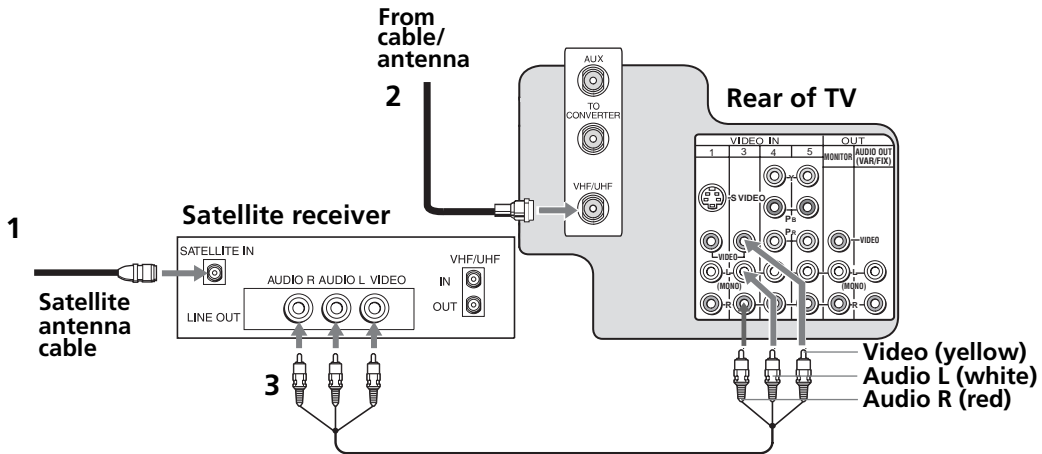

## Connecting a TV and Satellite Receiver



- 1** Connect the cable from your satellite antenna to SATELLITE IN on your satellite receiver.
- 2** Connect the coaxial cable from your cable service or antenna to the VHF/UHF jack on your TV.
- 3** Using audio/video cables (not supplied), connect AUDIO/VIDEO OUT on your satellite receiver to AUDIO/VIDEO IN on your TV.

### Using your TV with this connection



This connection allows you to do the following:

- Program your Sony remote control to operate your satellite receiver (see page 8).
- To activate your remote, press  to operate your satellite receiver. See page 7 on how to operate other functions.
- Press  repeatedly to switch to satellite receiver input (VIDEO input).

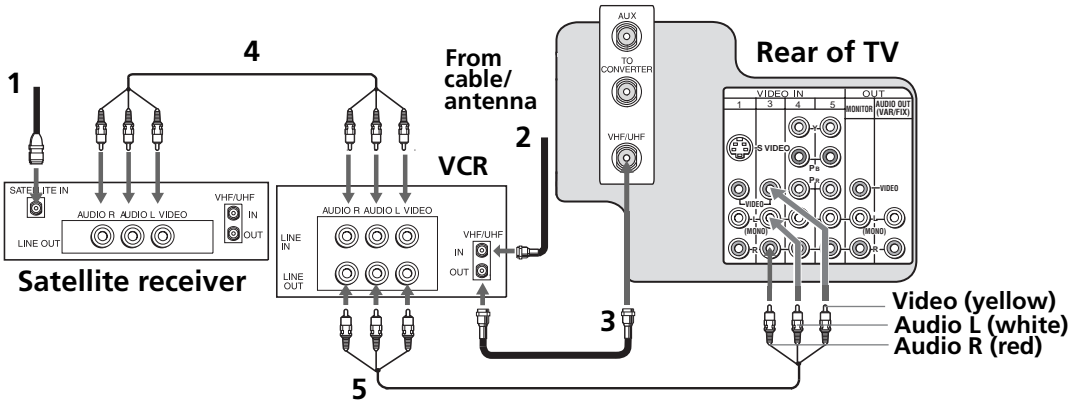
## Connecting a TV, VCR, and Satellite Receiver





- 1** Connect the coaxial cable from your satellite antenna to SATELLITE IN on the satellite receiver.
- 2** Connect the coaxial cable from your cable service or antenna to the IN jack on your VCR.
- 3** Using a coaxial cable (not supplied), connect the OUT jack on your VCR to the VHF/UHF jack on your TV.
- 4** Using audio/video cables (not supplied), connect AUDIO/VIDEO OUT on your satellite receiver to AUDIO/VIDEO IN on your VCR.
- 5** Using audio/video cables (not supplied), connect AUDIO/VIDEO OUT on your VCR to AUDIO/VIDEO IN on your TV.

 To view from the satellite receiver or VCR, select the video input to which your satellite receiver or VCR is connected by pressing  on the remote control.

### Using your TV with this connection

This connection allows you to do the following:

- Program your Sony remote control to operate your VCR or satellite receiver (see pages 7-8).
- Turn on your VCR to enable your satellite receiver to work with this connection.
- To activate your remote, press  to operate your VCR or  to operate your satellite receiver.
- Press  repeatedly to switch between VCR input (VIDEO input), VHF/UHF (local channels or unscrambled), or your cable box (cable system or scrambled channels).

## Connecting a DVD Player

Using audio/video cables (not supplied), connect AUDIO/VIDEO OUT on your DVD player to AUDIO/VIDEO IN on your TV.

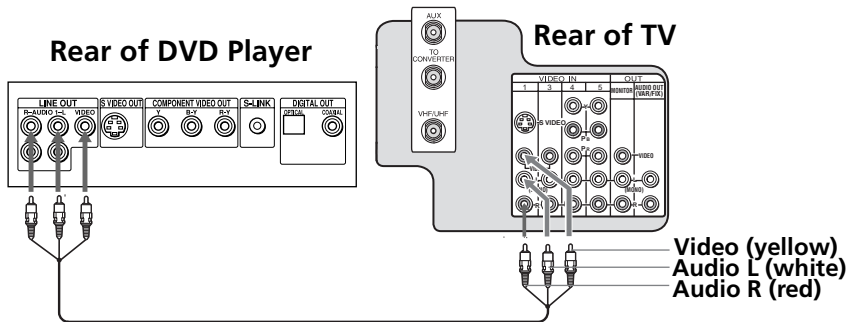

### Optional connection

- ❑ For better picture quality, use S VIDEO instead of the yellow video cable. S VIDEO does not provide sound, so you still must connect the audio cables.
- ❑ If your DVD player is equipped with component video outputs (Y, P<sub>B</sub>, P<sub>R</sub>), you can improve the picture quality by using component video cables (480i only). This connection can be done on VIDEO 4 or 5 (both Y, P<sub>B</sub>, P<sub>R</sub>).

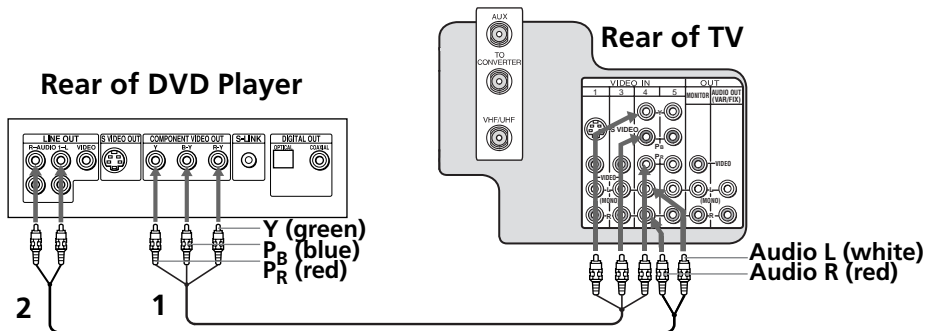



- 1** Using component video cables (not supplied), connect the Y, P<sub>B</sub>, P<sub>R</sub> OUT on your DVD player to Y, P<sub>B</sub>, P<sub>R</sub> IN on your TV.
- 2** Connect AUDIO OUT on your DVD player to AUDIO IN on your TV.

 The Y, P<sub>B</sub>, P<sub>R</sub> outputs on your DVD player are sometimes labeled Y, C<sub>B</sub>, and C<sub>R</sub> or Y, B-Y, and R-Y. If so, connect the cables to like colors.

### Using your TV with this connection

This connection allows you to do the following:

- ❑ Program your Sony remote control to operate your DVD (see page 7).
- ❑ To activate your remote, press  to operate your DVD.
- ❑ Press  repeatedly to switch to the DVD player's input (VIDEO input).



## Connecting a Camcorder

To connect your camcorder, you can use the Audio/Video inputs on either the front or rear panel of the TV. Using the audio/video cables (not supplied), connect the AUDIO/VIDEO OUT on your camcorder to the AUDIO/VIDEO IN on your TV.

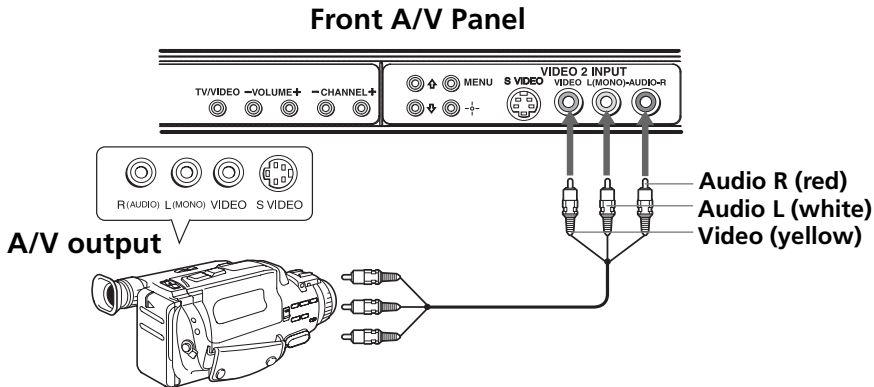

### Optional connection

- ❑ For better picture quality, use S VIDEO instead of the yellow video cable. S VIDEO does not provide sound, so you still must connect the audio cables.

## Connecting an Audio System

- 1 Using audio/video cables (not supplied), connect AUDIO OUT on your TV to one of the unused line inputs (e.g. TV, AUX, TAPE2) on your stereo.
- 2 Set the Speaker option to Off. For more instructions, see "Using the Audio Menu" on page 31.
- 3 Open the Audio Out option on the Audio Menu and select Fixed to control the volume through the connected audio system. For more instructions, see "Using the Audio Menu" on page 32.

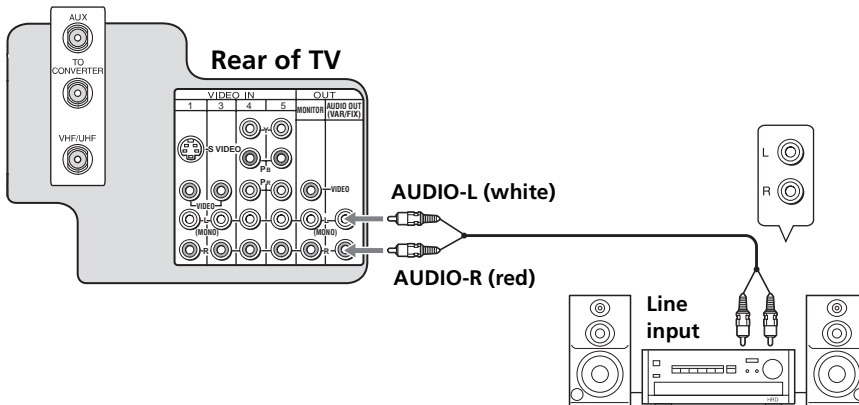

## Connecting Two VCRs for Tape Editing

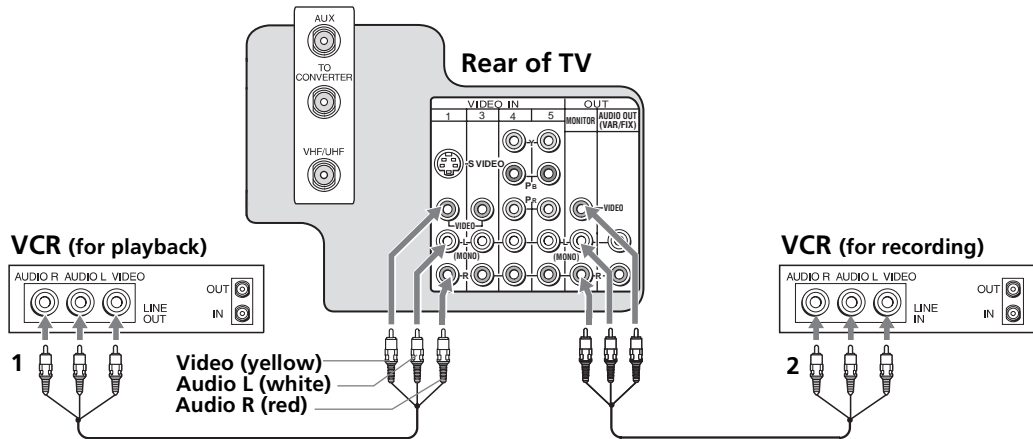

You can connect two VCRs together to edit video tapes. You can also connect both VCRs to your TV to view the program being recorded.



- 1** Using audio/video cables (not supplied), connect AUDIO/VIDEO OUT on your first VCR to AUDIO/VIDEO IN on your TV.
- 2** Using audio/video cables (not supplied), connect AUDIO/VIDEO IN on the second VCR to the MONITOR AUDIO/VIDEO OUT on your TV.

### Using your TV with this connection

This connection allows you to do the following:

- Program your Sony remote control to operate your VCR (see page 7).
- To activate your remote press  to operate your VCR, see page 7 on how to operate other functions.
- Press  repeatedly to switch DVD input (VIDEO inputs).



# Using Basic Functions

## Setting Up the TV

After you have finished connecting your TV, you can use Auto Program to set up your channels. During Auto Program, the TV will automatically search for available channels and program receivable channels.

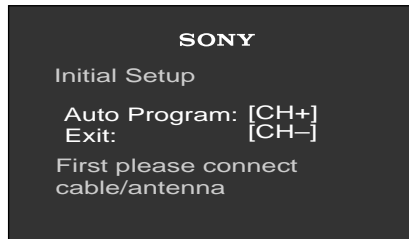









- 1 Press  to turn on the TV. The Initial Setup screen appears.





- 2 Press  on the remote control or on the TV front panel to start Auto Program, or press  to exit.

 The Initial Setup screen appears each time you turn on the TV until you perform Auto Program.

### To perform Auto Program again



- 1 Press .
- 2 Press  to highlight Channel Setup Menu.
- 3 Press  to highlight Cable. Press  to select.
- 4 Press  or  to highlight On or Off according to how you connected your TV. Press  to select.
- 5 Press  to highlight Auto Program. Press  to search for channels.
- 6 After Auto Program finishes, press  to exit.

### To reset the TV to factory settings

- 1 Turn the TV on.
- 2 Hold down  on the remote control.
- 3 Press and release the POWER button on the TV front panel. The TV will turn itself off, then back on.
- 4 Release .

## Quick Start to the Menus

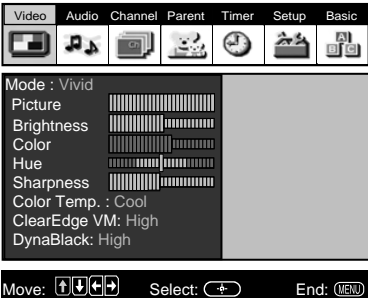
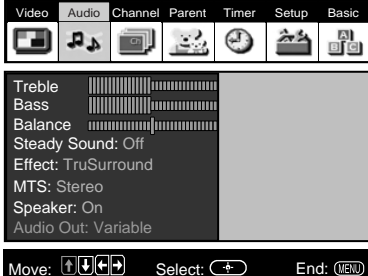
The following settings are available in your on-screen menus. For more details on how to use the menus, see “Using the Menus” on page 29.

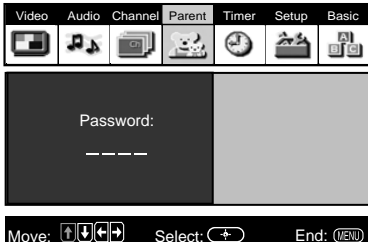
Menu	Allows you to
 <p>Video   Audio   Channel   Parent   Timer   Setup   Basic</p> <p>Mode : Vivid            Picture            Brightness            Color            Hue            Sharpness            Color Temp. : Cool            ClearEdge VM: High            DynaBlack: High</p> <p>Move: [Up] [Down] [Left] [Right]    Select: [Enter]    End: [MENU]</p>	<p>Adjust your picture settings.</p>
 <p>Video   Audio   Channel   Parent   Timer   Setup   Basic</p> <p>Treble            Bass            Balance            Steady Sound: Off            Effect: TruSurround            MTS: Stereo            Speaker: On            Audio Out: Variable</p> <p>Move: [Up] [Down] [Left] [Right]    Select: [Enter]    End: [MENU]</p>	<p>Change your audio settings.</p>
 <p>Video   Audio   Channel   Parent   Timer   Setup   Basic</p> <p>Favorite Channels            Cable : On            Channel Fix: Off            Auto Program            Channel Skip/Add            Channel Label</p> <p>Move: [Up] [Down] [Left] [Right]    Select: [Enter]    End: [MENU]</p>	<p>Customize your channel settings.</p>
 <p>Video   Audio   Channel   Parent   Timer   Setup   Basic</p> <p>Password:            _ _ _ _</p> <p>Move: [Up] [Down] [Left] [Right]    Select: [Enter]    End: [MENU]</p>	<p>Set rating limits on your TV based on program rating or content.</p>

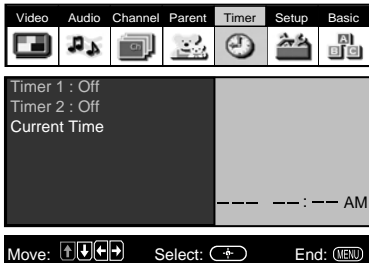
**Menu****Allows you to**

Set the clock on your TV and program scheduled viewing using Timer 1 and Timer 2.



Select closed captioning options, label video inputs, adjust tilt correction, enhance your DVD picture resolution. (16:9 Enhanced), select menu language, or run a demo of the menus.

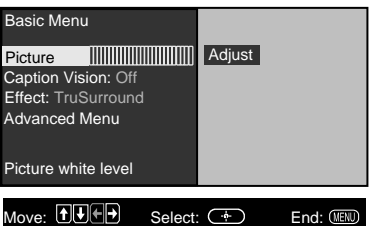
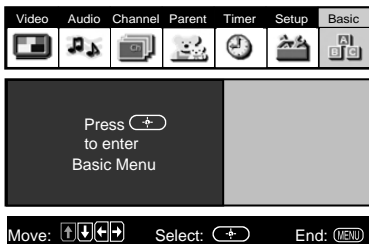

Access the most commonly used menu settings.

## Using Picture in Picture (PIP)

The Picture-in-Picture (PIP) feature allows you to view two programs simultaneously, one in the full size “main” picture and one in a small “window” picture.

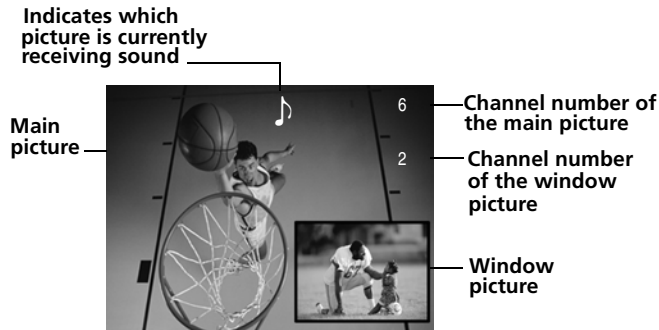

### Displaying Picture in Picture



#### To use PIP

- 1 Press the TV button to control PIP with the yellow buttons. Tune your TV to a channel that you know is currently airing programming.
- 2 Press  to display the window picture.
- 3 Use the yellow PIP (CH +/-) buttons to change the channel in the PIP window picture.









#### To check your PIP

- 1 Press the TV button to control PIP with the yellow buttons. Tune your TV to a channel, which you know is currently airing programming.
- 2 Press  to turn PIP on, then press . The channel from the main window should now appear in the window picture.
- 3 Use the (CH +/-) buttons on the bottom of your remote control to select the same channel in the main picture.
- 4 Use the yellow PIP (CH +/-) buttons to change the channel in the PIP window picture.
- 5 Press the yellow  PIP button to switch the PIP window to other video inputs for other equipment that is connected to any of the VIDEO IN jacks of your TV. You should see a different picture in your PIP window for each piece of connected video equipment. Make sure the connected equipment is turned on and working when you perform this test.

 If you're having problems with PIP, refer to “Connections that affect your ability to use PIP” on page 28 or see “Other Information” on page 45 for possible solutions.

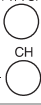

## PIP Function buttons

Yellow PIP button	Description
	Press to turn the PIP feature on and off. Press repeatedly to change the window size (1/9, 1/16, Off).
	Press to cycle through the available video equipment you have connected to the TV in the PIP window picture.
	Press to alternate sound between the main picture and the PIP window picture. The sound symbol  appears for three seconds, indicating whether you are hearing the sound from the main or PIP window picture.
	Press to change the channel in the PIP window picture. To change the channel in the main window, use the main (CH +/-) buttons at the bottom of the remote control.
	Press to move the location of the window picture to any of the four corners of the screen.
	Press to freeze the window picture. Press again to restore the picture. The main window continues to play as usual.
	Press to switch the main picture with the PIP window picture. Press again to switch back.

 For more information about your remote control, see "Using the Remote Control" on page 3.

### To change channels/programs in the PIP window

- Use the yellow PIP (CH +/-) button to scroll through TV channels.
- Use the yellow TV/VIDEO button to cycle through other video equipment connected to the TV, such as your VCR, DVD player, or satellite receiver.

### Connections that affect your ability to use PIP







- ❑ Any video equipment you have connected to the AUX input cannot be viewed in the PIP window.
- ❑ If you are viewing all channels through a cable box, the PIP feature will not work. The cable box only unscrambles one signal at a time, so the window picture will be the same as the main picture. See page 15 for more information on how to connect your cable box and use your PIP feature.
- ❑ Connected equipment in VIDEO 4-5 (Y, P<sub>b</sub>, P<sub>r</sub>) is not visible in PIP.



# Using the Menu

This section shows the options available for setting up and adjusting the TV.

## How to Access Menus

### To Access Menu

- 1** Press  to display the on-screen menu.
- 2** Use the  or  buttons to highlight the desired menu icon. Press  to select it.
- 3** Use the  or  buttons to scroll up and down through the features.
- 4** Follow the instructions on the screen.
- 5** For instructions on using a specific menu, see the page in this section that talks about that menu.
- 6** Press  to exit the menu.

 Press  once to display the on-screen menu, and press again to return to normal viewing. If no buttons are pressed, the menu closes automatically after about 90 seconds.

## Using the Video Menu



To access the Video menu, use the following steps:

### To Display



### To Select



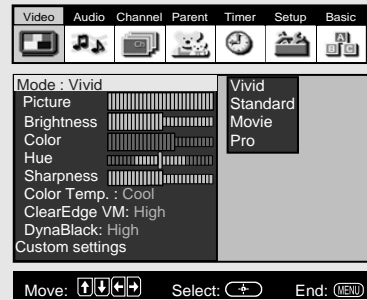

Press  to highlight an option; then press .



### Mode

*Customized picture viewing*

Use the  or  buttons to highlight one of the following options, then press  to select it.

- Vivid:** Select for enhanced picture contrast and sharpness.
- Standard:** Select for a standard picture.
- Movie:** Select for a finely detailed picture.
- Pro:** Select for natural picture and sharpness.



Press



on the remote control for direct access to the picture modes (Vivid, Standard, Movie, Pro).

### Picture

Press  to decrease the contrast. Press  to increase the contrast.



### Brightness

Press  to darken the picture. Press  to brighten the picture.

### Color

Press  to decrease color saturation. Press  to increase color saturation.

### Hue



Press  to increase the red tones. Press  to increase the green tones.

### Sharpness

Press  to soften the picture. Press  to sharpen the picture.



### Color Temp.

*White tint adjustment*

Use the  or  buttons to highlight one of the following options, then press  to select it.

- Cool:** Gives white colors a blue tint.
- Neutral:** Gives white colors a neutral tint.
- Warm:** Gives white colors a red tint.

### ClearEdge VM

Sharpens picture definition to give objects a crisp, clean edge. Use the  or  buttons to highlight one of the following options: **High**, **Low**, **Off**, then press  to select it.



### DynaBlack

Improves contrast and sharpens image detail. Use the  or  buttons to highlight one of the following options: **High**, **Low**, **Off**, then press  to select it.













## Using the Audio Menu



To access the Audio menu, use the following steps:





Press  to highlight an option; then press .



<b>Treble</b>	Press  to decrease the higher pitched sounds. Press  to increase the higher pitched sounds.
<b>Bass</b>	Press  to decrease the lower pitched sounds. Press  to increase the lower pitched sounds.
<b>Balance</b>	Press  to emphasize the left speaker. Press  to emphasize the right speaker.
<b>Steady Sound</b>	Use the  or  buttons to highlight one of the following options, then press  to select it. <b>On:</b> Select to stabilize the volume when changing the channels. <b>Off:</b> Select to turn Steady Sound Off.
<b>Effect</b>	Use the  or  buttons to highlight one of the following options, then press  to select it. <b>Simulated:</b> Simulates theater quality sound for mono programs. <b>WOW:</b> Provides a dramatic presence with a full, deep bass sound. When WOW is enabled, BBE is activated to further enhance the audio performance. <b>TruSurround:</b> Produces a dynamic three-dimensional sound for stereo audio signals. <b>Off:</b> Provides normal stereo or mono reception.







 Press  to directly select Effect settings (Simulated, WOW, TruSurround, Off).

<b>MTS</b> <i>Multi-Channel TV Sound</i>	Use the  or  buttons to highlight one of the following options, then press  to select it. <b>Stereo:</b> Select when viewing a broadcast in stereo. <b>Auto SAP:</b> Select to have the TV automatically switch to a Second Audio Program (SAP) when a signal is received. <b>Mono:</b> Select to reduce noise in areas of poor reception.
---	--

 Press  to directly select MTS settings (Stereo, Auto SAP, Mono).

 If your TV is set to Auto SAP, some programs may be muted or distorted. If your TV does not output sound, change your Audio MTS setting to Stereo or Mono.

---

<b>Speaker</b> <i>Custom selection of audio output source</i>	Use the  or  buttons to highlight one of the following options, then press  to select it. <b>On:</b> Select to listen to the sound from the TV speakers with or without a separate stereo system. <b>Off:</b> Select to turn off the TV speakers and listen to the TV's sound only through external audio system speakers.
<b>Audio Out</b> <i>Use to control the TV's volume through a stereo</i>	Use the  or  buttons to highlight one of the following options, then press  to select it. <b>Variable:</b> Adjust the volume through your TV. <b>Fixed:</b> Adjust the volume through a connected stereo.



---

 You can only set Audio Out settings when you have set Speaker to Off.

## Using the Channel Menu

To access the Channel menu, use the following steps:















Press  to highlight an option; then press .





### **Favorite Channels**

*Quick access to favorite channels*

- 1 Use the  or  buttons to highlight the position (1-8) where you want to set a favorite channel, then press .
- 2 Use the  or  buttons to find the channel you want to add to your favorite channels.
- 3 Press  to select the channel. The TV will automatically change to the selected channel.
- 4 Press  to return to the Channel menu or press  to exit.

 To use Favorite Channels, exit all menus and press . Press  or  to move the cursor to the desired channel number and press .



### **Cable**

Use the  or  buttons to highlight one of the following options, then press  to select it.

- On:** Select if you are receiving cable channels with a CATV cable.  
**Off:** Select if you are using a TV antenna.

 After changing your cable settings, you will need to perform Auto Program. See "To perform Auto Program again" on page 23

### **Channel Fix**

Use the  or  buttons to highlight one of the following options, then press  to select it.

- Off:** Channel Fix is not set.
- 2-6:** Select when you want to control all channel selection through a cable box or VCR. Select the appropriate channel (usually 3 or 4) and use the cable box's or VCR's remote control for channel selection.
- AUX 2-6:** Select this setting instead of **2-6** if you want to change channels using a cable box, VCR, or satellite receiver and you've connected it to the AUX input.
- Video 1:** Select from available video inputs when you have connected video equipment (e.g., a satellite receiver) and you want your TV fixed to it.

 You cannot use Favorite Channels, Cable, Channel Skip/Add, or Channel Label when Channel Fix is set.



---

**Auto Program** Perform Auto Program whenever setting up your TV.  
Auto Program will search for available channels and program receivable channels.

---

**Channel Skip/Add** Use this feature after you run Auto Program to skip unwanted channels or add new ones.

- 1 Use the  $\uparrow$  or  $\downarrow$  buttons to highlight the position of the desired channel, then press  $\ominus$ .
- 2 Use the  $\uparrow$  or  $\downarrow$  buttons to highlight **Skip** or **Add**, then press  $\ominus$ .
- 3 Press  $\leftarrow$  to return to the Channel menu or press  $\text{MENU}$  to exit.

 Press CH + or CH - to skip over channels that have been skipped. You can still use the  $\text{0-9}$  buttons to directly tune to skipped channels.

---

**Channel Label**

*Label up to 40 channels with their call letters*

- 1 Press  $\ominus$ , then use the  $\uparrow$  or  $\downarrow$  buttons until you reach the desired channel number.
  - 2 Press  $\ominus$  to activate the channel.
  - 3 Press  $\downarrow$  to highlight **Label**, then press  $\ominus$ . Use the  $\uparrow$  or  $\downarrow$  buttons to display the first call letter or number of the label. Press  $\ominus$  to select. Repeat this process until you finish selecting all the call letters.
  - 4 When finished, press  $\ominus$  to activate.
  - 5 Press  $\leftarrow$  to return to the Channel menu or press  $\text{MENU}$  to exit.
-

## Using the Parent Menu

To access the Parent menu, use the following steps:

**To Display**



**To Highlight**



**To Select**



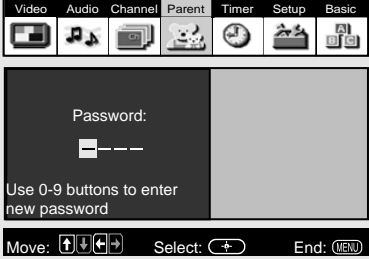

The diagram shows a TV screen with a menu bar at the top containing: Video, Audio, Channel, Parent, Timer, Setup, and Basic. The Parent menu is highlighted. Below the menu bar, the screen displays 'Password:' followed by a dashed line for input. A note below says 'Use 0-9 buttons to enter new password'. At the bottom, there are navigation controls: Move (up, down, left, right arrows), Select (right arrow with +), and End (MENU button).

The Parental Control feature helps parents monitor what their children watch on television.

### To use the Parent Menu

When you select the Parent menu, you are prompted to set a 4-digit password. You cannot access the Parent menu settings without this password.

- 1** Use the 0-9 buttons to enter a 4-digit password.
- 2** Confirm your password by entering it again.

 Keep this manual in a safe place. You need your password for any future access to the Parent menu. If you forget your password, see page 45.

## Parental Control

### Setting the Rating

You can change the Rating by selecting one of the Parental Lock options.

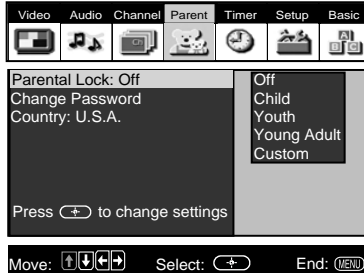

- 1 Press  $\downarrow$  to highlight **Parental Lock**; then press  $\text{Enter}$ .

If you are not familiar with Parental Guideline rating system, use one of the following preset categories to simplify the rating selection: Child, Youth, Young Adult.

- 2 Use the  $\uparrow$  or  $\downarrow$  to highlight the desired rating and press  $\text{Enter}$ .

Rating	TV will allow a maximum rating of
Off	No rating limit
Child	TV-Y, TV-G, G (U.S.), G, C (Canada)
Youth	TV-PG, PG (U.S.), 8 ans + (Canada)
Young Adult	TV-14, PG-13 (U.S.), 14+ (Canada)
Custom	Select to set more restrictive ratings (see next section)

### Changing your Password

- 1 Use the  $\uparrow$  or  $\downarrow$  buttons to highlight **Change Password** and press  $\text{Enter}$ .
- 2 Follow steps 1 and 2 for “Using the Parent Menu” on page 35.



### Select a Country

Select U.S.A. to use US ratings (see pages 38-39) or select Canada to use Canadian ratings (see page 40). If you select a Country (U.S.A. or Canada) that is not where you live, the rating you select will not be activated.

- 1 Press  $\downarrow$  to highlight **Country**, then press  $\text{Enter}$ .
- 2 Use the  $\uparrow$  or  $\downarrow$  to highlight the desired country and press  $\text{Enter}$ .

## Information for Parents

### To view a program that exceeds the TV rating

- Press , then use the - buttons to enter your password.

 Entering your password to view a blocked program will temporarily turn **Parental Lock** to Off. To reactivate your Lock settings, turn the TV off then back on; the TV will return to the settings that you have selected.

## Using the Custom Menu

Follow the instructions on the screen to make your custom settings. Select the country desired for your TV's rating limit. See page 38 for U.S. models and page 40 for Canadian models for more information.

 Once you have blocked a rating or content, all higher ratings or content will be automatically blocked.

## United States: Selecting Custom Rating Options

For the United States, the Custom Rating menu includes the following options: Movie Rating, TV Rating and Unrated. (For Canada, see page 40.)

### Movie Rating

This system defines the rating levels of movies shown in theaters and on prime cable channels.

Rating	Defined as
<b>G</b>	General audience
<b>PG</b>	Parental guidance suggested
<b>PG-13</b>	Parents strongly cautioned
<b>R</b>	Restricted
<b>NC-17</b>	No one 17 and under admitted
<b>X</b>	Adult audience only

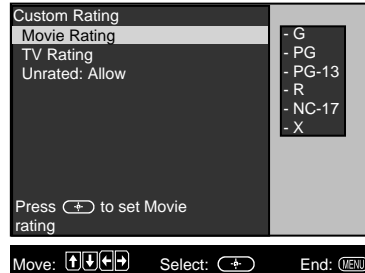

### TV Rating

The TV rating is divided into two groups: age-based and content-based.

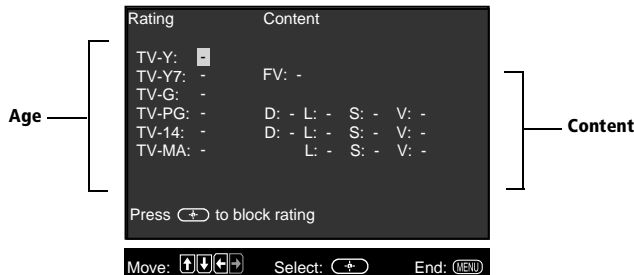

Age	Defined as
<b>TV-Y</b>	All children
<b>TV-Y7</b>	Directed to older children
<b>TV-G</b>	General audience
<b>TV-PG</b>	Parental guidance suggested
<b>TV-14</b>	Parents strongly cautioned
<b>TV-MA</b>	Mature audience only

Content	Defined as
<b>FV</b>	Fantasy violence
<b>D</b>	Suggestive dialogue
<b>L</b>	Strong language
<b>S</b>	Sexual situations
<b>V</b>	Violence

The content ratings will increase depending on the level of the age-based rating. For example, a program with a TV-PG V (Violence) rating may contain moderate violence, while a TV-14 V (Violence) rating may contain intense violence.

## Unrated

You have the option of blocking TV programs or movies that are not rated.

<b>Allow</b>	Allows all unrated programs
<b>Block</b>	Blocks all unrated programs

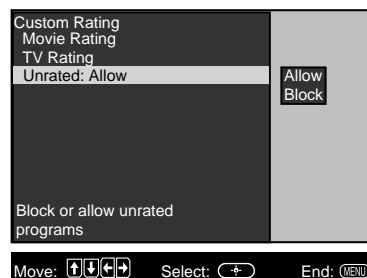

 If you choose to block unrated TV programs, please be aware that the following programs may be blocked: emergency broadcasts, political programs, pro, news, public service announcements, religious programs, and weather.

## Canada: Selecting Custom Rating Options

For Canada, the Custom Rating menu includes the following options: English Rating, French Rating, and U.S.A. Rating.

### English Rating

These ratings are for Canadian programs that are broadcast in English.

Rating	Defined as
<b>C</b>	Children
<b>C8+</b>	Children 8 years and older
<b>G</b>	General programming
<b>PG</b>	Parental guidance
<b>14+</b>	Viewers 14 and older
<b>18+</b>	Adult programming

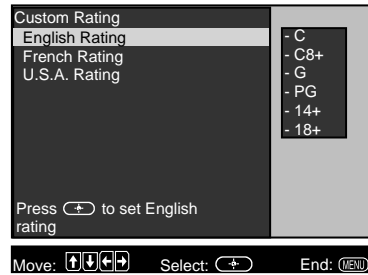

### French Rating

These ratings are for Canadian programs that are broadcast in French.

Rating	Defined as
<b>G</b>	General
<b>8 ans+</b>	Not recommended for younger children
<b>13 ans+</b>	Not recommended for children under age 13
<b>16 ans+</b>	Not recommended for ages under 16
<b>18 ans+</b>	This program is restricted to adults

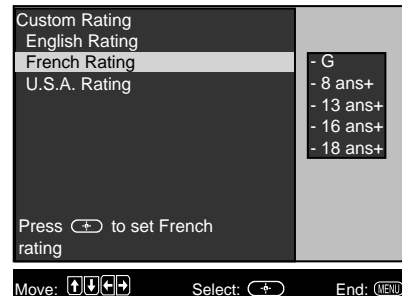

### U.S.A. Rating

For programs from the United States, see “TV Rating” on page 38.





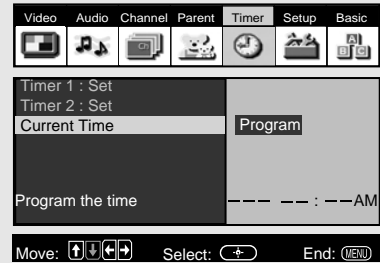

## Using the Timer Menu

To access the Timer menu, use the following steps:









**Current Time** Set your TV to the current day and time. Press  to open the Current Time menu:

- 1 Use the  or  buttons to enter the correct day and time, then press .
- 2 Press  to exit the menu.

 You must set the Current Time before you can use Timer 1 or Timer 2.

**Timer 1 and Timer 2** Use the timers to program your TV to turn on and off by day, time, duration, and channel. The timer duration is a maximum of six hours. When the channel is fixed, it is not necessary to set the channel.

*Scheduled viewing*

- 1 Use the  or  buttons to highlight Timer 1 or Timer 2, then press .
- 2 Use the  or  buttons to enter the desired day, start time, duration, and channel, then press . The timer status should be On when the Timer has been set, and the timer light on the front panel of the TV should be on.
- 3 Press  to exit the menu.



 Select Off to turn off the Timer. Your previous settings will be saved.

 When you perform Auto Program, Timer 1 and Timer 2 settings will be cleared. Also, in the event of any loss of power, Current Time, Timer 1, and Timer 2 settings will be cleared.

## Using the Setup Menu

To access the Setup menu, use the following steps:





Press  to highlight an option; then press .



### Caption Vision

*Closed-Captioning*

Allows you to select from three closed caption modes for programs that are broadcast with closed captioning.









Use the  or  buttons to highlight one of the following options, then press  to select it.

- Off:** Caption Vision is not activated.
- CC1, 2, 3, 4:** Displays printed dialogue and sound effects of a program.
- Text1, 2, 3, 4:** Displays network/station information.
- Info:** Displays the name of the current program and its remaining time (if available) when you change the channel or press the DISPLAY button.

### Video Label



*Label connected equipment*

Allows you to identify the audio/video components connected to the TV: VCR, DVD, etc. When you press TV/VIDEO to switch inputs, the Video Label appears on-screen.



- 1 Press the  or  buttons to highlight the input you want to label and press .
- 2 Press the  or  buttons to highlight a label and press .
- 3 Press  to return to the Setup menu or press  to exit.

 If you select **Skip**, your TV skips this connection when you press the TV/VIDEO button.

### Tilt Correction

Use the  or  buttons to set the tilt of the picture from -5 to +5, then press  to activate.

### Language

Display all menus in the language of your choice. Use the  or  buttons to select from one of the following options: **English**, **Español** (Spanish) and **Français** (French). Then press .

### 16:9 Enhanced

Provides enhanced picture resolution for wide-screen sources such as DVD. This is only available when the TV is in Video mode.

### Demo

Press  to run a demonstration of the on-screen menus.

 You can press any button to exit Demo mode.

## Using the Basic Menu

To access the Basic menu, use the following steps:

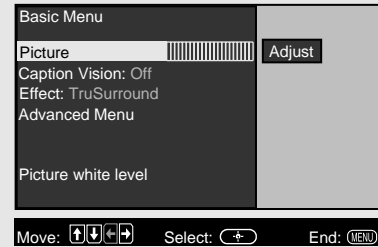
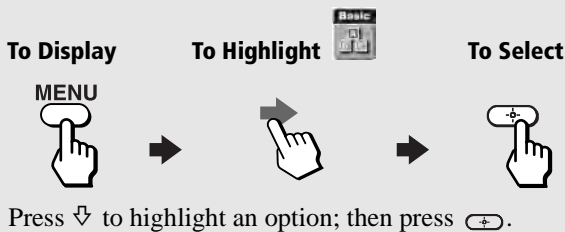

**Picture** Press  to decrease picture contrast.

*Picture contrast* Press  to increase picture contrast.

**Caption Vision** The Basic menu displays the current Caption Vision setting. By default, this is Off.  
*Closed-Captioning*

**Effect** Use the  or  buttons to highlight one of the following options, then press  to select it.





**Simulated:** Simulates theater quality sound for mono programs.

**WOW:** Provides a dramatic presence with a full, deep bass sound. When WOW is enabled, BBE is activated to further enhance the audio performance.

**TruSurround:** Produces a dynamic three-dimensional sound for stereo audio signals.

**Off:** Normal stereo or mono reception.

**Advanced Menu** Press  to return to the advanced menus.



 If you use the  button to close the Basic menu, only the Basic menu appears when you press  again. To access the other menus, press  to highlight Advanced Menu, then press .

# Other Information

## Troubleshooting

If you have a problem with your TV, try the suggestions below. If the problem persists, see “Contacting Sony” at the end of this section.

### General

Problem	Possible Remedies
<b>I want to reset the TV to the factory settings</b>	<ul style="list-style-type: none"><li>❑ Turn on the TV. While holding down the RESET button on the remote control, press POWER button on the TV front panel. The TV will turn itself off, then back on again. Release the RESET button.</li></ul>
<b>I cannot access other menus when I am in the Basic menu</b>	<ul style="list-style-type: none"><li>❑ If you use the  to close the Basic menu, only the Basic menu appears when you press  again. To access the other menus, select the advanced menu option (page 43).</li></ul>
<b>The TV is dirty</b>	<ul style="list-style-type: none"><li>❑ Clean the TV with a soft dry cloth. Never use strong solvents such as thinner or benzine, which might damage the finish of the cabinet.</li></ul>
<b>I lost the parental control password</b>	<ul style="list-style-type: none"><li>❑ In the password screen, enter the following master password: 4357. After using the master password, you must create a new password. You cannot use the master to unlock currently blocked channels.</li></ul>
<b>There is a black box on the screen</b>	<ul style="list-style-type: none"><li>❑ You have selected a text option in the Setup menu (page 42) and no text is available. To turn off this feature, select Off in the Caption Vision option. If you were trying to select closed captioning, select CC1-4 instead of Text1-4.</li></ul>
<b>There was a blackout or power outage, and now the TV won't turn on and the timer LED is flashing</b>	<ul style="list-style-type: none"><li>❑ Press the POWER button on your remote control or on the TV front panel.</li></ul>
<b>Digital cable box does not work</b>	<ul style="list-style-type: none"><li>❑ Be sure that you have not connected the digital cable box to the TV's TO CONVERTER jack. This jack is not compatible with digital cable boxes.</li><li>❑ If you are connecting a VCR and digital cable box using a splitter, as described in pages 15-16, you must use a special bi-directional splitter that is designed to work with your digital cable box. Contact your cable provider for details.</li></ul>

### Remote Control

Problem	Possible Remedies
<b>I cannot operate the remote control</b>	<ul style="list-style-type: none"><li><input type="checkbox"/> Press TV (FUNCTION) when operating your TV.</li><li><input type="checkbox"/> Check the orientation of the batteries.</li><li><input type="checkbox"/> Batteries could be weak. Replace them (page 2).</li><li><input type="checkbox"/> Move the TV three to four feet away from fluorescent lights.</li></ul>
<b>I cannot change channels with the remote control</b>	<ul style="list-style-type: none"><li><input type="checkbox"/> Make sure you have not inadvertently switched your TV from the channel 3 or 4 setting if you are using another device to change channels.</li><li><input type="checkbox"/> If you are using another device to control channels, be sure that you have pressed the FUNCTION button for that device. For example, if you are using your VCR to control channels, be sure to press the VCR/DVD FUNCTION button (page 4).</li></ul>
<b>I lost the remote control</b>	<ul style="list-style-type: none"><li><input type="checkbox"/> You can use the front panel controls to access your menus, change channels, adjust the volume, or change video inputs (page 2). Contact your nearest Sony Dealer to order a replacement, please call our Sony Direct Accessory and Part Center at 1-800-488-7669 (U.S. residents only).</li></ul>



### Programming The Remote Control

Problem	Possible Remedies
<b>More than one code is listed</b>	<ul style="list-style-type: none"><li><input type="checkbox"/> Try entering them one by one until you come to the correct code for your component.</li></ul>
<b>I entered the wrong code number</b>	<ul style="list-style-type: none"><li><input type="checkbox"/> If you enter a new code number, the code number you previously entered at that setting is erased.</li></ul>
<b>I cannot operate a component with the remote control</b>	<ul style="list-style-type: none"><li><input type="checkbox"/> Use the component's own remote control.</li></ul>
<b>When I changed the batteries, the code numbers changed back to the factory settings</b>	<ul style="list-style-type: none"><li><input type="checkbox"/> You must reprogram the remote control.</li></ul>

## Video

Problem	Possible Remedies
<b>No picture, no sound</b>	<ul style="list-style-type: none"> <li><input type="checkbox"/> Make sure the power cord is plugged in.</li> <li><input type="checkbox"/> If a red light is flashing on the front of your TV for more than a few minutes, disconnect and reconnect the power cord. If the problem continues, call your local service center.</li> <li><input type="checkbox"/> Check the TV/VIDEO setting: when watching TV, set it to TV; when watching video equipment, set it to VIDEO 1, 2, 3, 4 or 5 (page 4).</li> <li><input type="checkbox"/> Make sure you have inserted the batteries correctly into the remote control (page 2).</li> <li><input type="checkbox"/> Try another channel to rule out station trouble.</li> </ul>
<b>Poor or no picture, good sound</b>	<ul style="list-style-type: none"> <li><input type="checkbox"/> Adjust the <b>Picture</b> setting in the Video menu (page 30).</li> <li><input type="checkbox"/> Adjust the <b>Brightness</b> setting in the Video menu (page 30).</li> <li><input type="checkbox"/> Check the antenna and/or cable connections (page 11).</li> </ul>
<b>No color</b>	<ul style="list-style-type: none"> <li><input type="checkbox"/> Adjust the <b>Color</b> setting in the Video menu (page 30).</li> </ul>
<b>Only snow appears on the screen</b>	<ul style="list-style-type: none"> <li><input type="checkbox"/> Check the <b>Cable</b> setting in the Channel menu (page 33).</li> <li><input type="checkbox"/> Check the antenna and/or cable connections (page 11).</li> <li><input type="checkbox"/> Make sure the channel selected is currently broadcasting.</li> </ul>
<b>Dotted lines or stripes</b>	<ul style="list-style-type: none"> <li><input type="checkbox"/> Adjust the antenna.</li> <li><input type="checkbox"/> Move the TV away from other electronic equipment. Some electronic equipment creates electrical noise, which can interfere with TV reception.</li> </ul>
<b>Double images or ghosts</b>	<ul style="list-style-type: none"> <li><input type="checkbox"/> Check your outdoor antenna or call your cable service.</li> </ul>

## Audio

Problem	Possible Remedies
<b>Good picture, no sound</b>	<ul style="list-style-type: none"> <li><input type="checkbox"/> Press  so that Muting disappears from the screen (page 3).</li> <li><input type="checkbox"/> Check your Audio settings. Your TV may be set to Auto SAP in the MTS feature (page 31).</li> <li><input type="checkbox"/> Make sure the speaker option is set to On in the Audio Menu.</li> <li><input type="checkbox"/> Press  to adjust your TV's volume.</li> </ul>

### Channels

Problem	Possible Remedies
<b>I cannot receive higher number channels (UHF) when using an antenna</b>	<ul style="list-style-type: none"> <li><input type="checkbox"/> Make sure <b>Cable</b> is set to Off in the Channel menu (page 33).</li> <li><input type="checkbox"/> Perform Auto Program to add channels that are not presently in the memory (page 23).</li> </ul>
<b>Cable stations don't seem to work</b>	<ul style="list-style-type: none"> <li><input type="checkbox"/> Make sure <b>Cable</b> is set to On in the Channel menu (page 33).</li> <li><input type="checkbox"/> Perform Auto Program to add channels that are not presently in the memory (page 23).</li> </ul>
<b>I cannot get anything but TV</b>	<ul style="list-style-type: none"> <li><input type="checkbox"/> Be sure that you did not set the video in the Setup menu (page 42) to skip your video inputs. If a video input has been set to <b>Skip</b>, it will be skipped when you press the TV/Video buttons for either the main or PIP pictures.</li> </ul>

### Picture in Picture (PIP)

Problem	Possible Remedies
<b>The remote control doesn't work in PIP mode</b>	<ul style="list-style-type: none"> <li><input type="checkbox"/> Press the TV FUNCTION button. You may have inadvertently pressed the VCR/DVD FUNCTION button, which changes the PIP buttons to VCR mode (page 26).</li> </ul>
<b>There is no window picture or it is just static</b>	<ul style="list-style-type: none"> <li><input type="checkbox"/> Be sure your PIP window picture is set to a video source/channel that has a program airing.</li> <li><input type="checkbox"/> You may be tuned to a video input with nothing connected to it. Try cycling through your video inputs using the yellow PIP TV/VIDEO button with the red dot (page 26).</li> </ul>
<b>I get the same program in the window picture as in the main picture</b>	<ul style="list-style-type: none"> <li><input type="checkbox"/> Both may be set to the same channel. Try changing channels in either the main picture or the window picture (page 26).</li> <li><input type="checkbox"/> Your TV may be set up to select all your channels through a cable box. The cable box will only unscramble one signal at a time, so you cannot use the PIP feature. If possible, run a direct cable to the VHF/UHF jack on your TV. This will only work if your cable system provides an unscrambled signal (page 13).</li> </ul>
<b>I cannot see VIDEO 4-5 (Y, P<sub>b</sub>, P<sub>r</sub>) in PIP</b>	<ul style="list-style-type: none"> <li><input type="checkbox"/> Connected equipment in VIDEO 4-5 (Y, P<sub>b</sub>, P<sub>r</sub>) is not visible in PIP.</li> </ul>

### Contacting Sony

Before calling our Customer Information Services Center, please have ready your TV's serial number. It is located on the rear of your TV or on the front cover of this manual. The person attending to your call will ask you for it.

Our Customer Information Services Center phone number is 1-800-222-SONY (7669) (US residents only) or (416) 499-SONY (7669) (Canadian residents only).



## Specifications

### For all models (except as noted)

Television system	American TV standard/NTSC		
Channel coverage	VHF: 2-13/UHF: 14-69/CATV: 1-125		
Antenna	75-ohm external antenna terminal for VHF/UHF		
Picture tube	FD Trinitron® tube		
Power requirements	120V, 60 Hz		
Supplied accessories	Size AA (R6) batteries (2) Remote Control RM-Y181 (1)		
Inputs/outputs	Inputs	1 video, 1 audio (front) 2 video, 2 audio (rear) 2 S VIDEO (1 front, 1 rear) 2 RF 2 Y, PB, PR, 2 audio	Outputs 1 AUDIO OUT 1 MONITOR OUT
Optional accessories	TV Stand: SU-27F1 for KV-27FV310 SU-32F1 for KV-32FV310 SU-36F1 for KV-36FV310		

#### **KV-27FV310**

Screen size	Visible screen size: 679 mm (27 inches) measured diagonally Actual screen size: 736.6 mm (29 inches) measured diagonally
Speaker output	7.5 W x 2, 15 W subwoofer
Power consumption	190 W in use 1 W in standby
Dimensions (W/H/D)	784 x 601.5 x 520 mm (30 <sup>7</sup> / <sub>8</sub> x 23 <sup>11</sup> / <sub>16</sub> x 20 <sup>4</sup> / <sub>8</sub> inches)
Mass	50.4 kg (111 lbs. 1.7 oz)

#### **KV-32FV310**

Screen size	Visible screen size: 803 mm (32 inches) measured diagonally Actual screen size: 863.6 mm (34 inches) measured diagonally
Speaker output	7.5 W x 2, 15 W subwoofer
Power consumption	200 W in use 1 W in standby
Dimensions (W/H/D)	898 x 682 x 584 mm (35 <sup>3</sup> / <sub>8</sub> x 26 <sup>7</sup> / <sub>8</sub> x 23 inches)
Mass	78 kg (171 lbs. 15.3 oz)

#### **KV-36FV310**

Screen size	Visible screen size: 911mm (36 inches) measured diagonally Actual screen size: 965.2 mm (38 inches) measured diagonally
Speaker output	7.5 W x 2, 15 W subwoofer
Power consumption	200 W in use 1 W in standby
Dimensions (W/H/D)	1020 x 760 x 640 mm (40 <sup>1</sup> / <sub>4</sub> x 30 x 25 <sup>1</sup> / <sub>4</sub> inches)
Mass	102 kg (224 lbs. 14 oz)

*Design and specifications are subject to change without notice.*

# Index

16:9 Enhanced **42**

## A

Audio Out **32**  
Auto Program **23, 34**  
Auto SAP **31**

## B

Balance **31**  
Bass **31**  
Batteries  
    Inserting in remote **2**  
    Replacing **2**  
    Supported **2**  
Brightness **30**

## C

Cable **33**  
Cable Box  
    Operating **8**  
    Connections **12**  
Caption Vision **42**  
Channel Fix **33**  
Channel Label **34**  
Channel Skip/Add **34**  
ClearEdge VM **30**  
Color **30**  
Color Temperature **30**  
Connections  
    Cable and antenna **11**  
    Cable Box and Cable **13**  
    Connecting a Camcorder **20**  
    Connecting a DVD Player **19**  
    Connecting an Audio System **20**  
    Connecting Two VCRs **21**  
    TV and Cable Box **12**  
    TV and Satellite Receiver **17**  
    TV and VCR **14**  
    TV, Satellite Receiver and VCR **18**  
    TV, VCR and Cable Box **15**  
Current Time **41**

## D

Demo **42**  
DISPLAY **3**  
DynaBlack **30**

## E

Effect  
    Off **31**  
    Simulated **31**  
    TruSurround **31**  
    WOW **31**

## F

Favorite Channels **33**  
Front Panel **2**

## H

Hue **30**

## L

Language **42**

## M

Menus  
    Audio **31**  
    Basic **43**  
    Channel **33**  
    Parent **35**  
    Setup **42**  
    Timer **41**  
    Video **30**  
Mode  
    Movie **30**  
    Pro **30**  
    Standard **30**  
    Vivid **30**  
MTS  
    Auto SAP **31**  
    Mono **31**  
    Stereo **31**

## P

Parental Control **36**  
Picture **30**  
Picture in Picture (PIP) **26**

## R

Ratings  
    English Rating **40**  
    French Rating **40**  
    Movie Rating **38**  
    TV Rating **38**

U.S.A. Rating **40**

Unrated **39**

Rear Panel **9**

Remote Control

    Description **3**

    Programming **5**

## **S**

Setting the Rating **36**

Sharpness **30**

SLEEP **3**

Speaker **32**

Specifications **49**

Steady Sound **31**

## **T**

Tilt Correction **42**

Timer 1 and Timer 2 **41**

Treble **31**

Troubleshooting **45**

TV Features **1**

## **V**

Video Label **42**

# LIMITED WARRANTY

This warranty is applicable to U.S. residents only. If you are a Canadian resident, see the separately enclosed warranty for your product.

Sony Electronics Inc. ("Sony") warrants this Product (including any accessories) against defects in material or workmanship, subject to any conditions set forth as follows:

1. **LABOR:** For a period of 90 days from the date of purchase, if this Product is determined to be defective, Sony will repair or replace the Product, at its option, at no charge, or pay the labor charges to any Sony authorized service facility. After the Warranty Period, you must pay for all labor charges.
2. **PARTS:** In addition, Sony will supply, at no charge, new or rebuilt replacements in exchange for defective parts for a period of one (1) year (color picture tube- two (2) years). After 90 days from the date of purchase, labor for removal and installation is available from Sony authorized service facilities or a Sony Service Center at your expense.
3. **ACCESSORIES:** Parts and labor for all accessories are for one (1) year.

In-home diagnostic warranty service is provided during the initial 90 day period for 19" (measured diagonally), or larger screen size through a Sony authorized service facility.

To obtain warranty service, you must take the Product, or deliver the Product freight prepaid, in either its original packaging or packaging affording an equal degree or protection, to any authorized Sony service facility.

This warranty does not cover customer instruction, installation, set up adjustments or signal reception problems.

This warranty does not cover cosmetic damage or damage due to acts of God, accident, misuse, abuse, negligence, commercial use, or modification of, or to any part of the Product, including the antenna. This warranty does not cover damage due to improper operation or maintenance, connection to improper voltage supply, or attempted repair by anyone other than facility authorized by Sony to service the Product. This warranty does not cover Products sold AS IS or WITH ALL FAULTS, or consumables (such as fuses or batteries). This warranty is valid only in the United States.

Proof of purchase in the form of a bill of sale or receipted invoice which is evidence that the unit is within the Warranty period must be presented to obtain warranty service.

This warranty is invalid if the factory applied serial number has been altered or removed from the Product.

---

REPAIR OR REPLACEMENT AS PROVIDED UNDER THIS WARRANTY IS THE EXCLUSIVE REMEDY OF THE CONSUMER. SONY SHALL NOT BE LIABLE FOR ANY INCIDENTAL OR CONSEQUENTIAL DAMAGES FOR BREACH OF ANY EXPRESS OR IMPLIED WARRANTY ON THIS PRODUCT, EXCEPT TO THE EXTENT PROHIBITED BY APPLICABLE LAW, ANY IMPLIED WARRANTY OF MERCHANTABILITY OR FITNESS FOR A PARTICULAR PURPOSE ON THIS PRODUCT IS LIMITED IN DURATION TO THE DURATION OF THIS WARRANTY.

---

Some states do not allow the exclusion or limitation of incidental or consequential damages, or allows limitations on how long an implied warranty lasts, so the above limitations or exclusions may not apply to you. In addition, if you enter into a service contract with the Sony Partnership within 90 days of the date of sale, the limitation on how long an implied warranty lasts does not apply to you. This warranty gives you specific legal rights, and you may have other rights which vary from state to state.

For your convenience, Sony Electronics Inc. has established telephone numbers for frequently asked questions:

To locate the servicer or dealer nearest you, or for service assistance or resolution of a service problem, or for product information or operation, call:

**Sony Customer Information Service Center**

1-(800)-222-7669

Or visit the Sony Web Site:

[www.sony.com](http://www.sony.com)

For an accessory or part not available from your authorized dealer, call:

1-(800)-488-SONY(7669)





**Mode d'emploi**

# AVERTISSEMENT

Afin d'éviter tout risque d'incendie ou d'électrocution, ne pas exposer cet appareil à la pluie ou à l'humidité.



Ce sigle vise à signaler à l'utilisateur la présence d'une "tension dangereuse" non isolée au sein de l'appareil, dont la puissance peut être suffisante pour provoquer un risque d'électrocution.



Ce sigle vise à signaler à l'utilisateur la présence d'une documentation importante concernant les instructions de fonctionnement et d'entretien de cet appareil.

## Remarque aux installateurs du système de télévision par câble

L'attention des installateurs du système de télévision par câble est attirée sur l'article 820-40 du NEC (National Electrical Code - États-unis) qui énonce les directives concernant le raccordement à la masse, stipulant en particulier qu'il doit être branché à celui de l'immeuble (ou maison), et aussi proche que possible du point d'entrée du câble.

## PRECAUTIONS DE SECURITE

- N'utiliser l'appareil que sur du courant alternatif 120 V.
- L'une des lames de la fiche est plus large que l'autre pour des raisons de sécurité et ne s'adapte dans la prise que dans un seul sens. Consultez votre revendeur si vous ne parvenez pas à brancher la fiche totalement.
- Si un liquide ou un objet quelconque venait à s'introduire dans l'appareil, débranchez immédiatement le cordon d'alimentation et faites vérifier le téléviseur par un technicien qualifié avant de le remettre en service.

## ATTENTION

Lorsque vous utilisez des jeux, des ordinateurs et d'autres appareils similaires avec votre téléviseur, réglez la brillance et le contraste à des valeurs basses. Une image restant fixe sur l'écran pendant un temps prolongé peut s'y imprimer en permanence lorsque la brillance ou le contraste sont trop élevés. De même, la visualisation continue d'un même canal peut provoquer l'impression du logo du canal. Ces impressions ne sont pas couvertes par votre garantie car elles résultent d'une utilisation incorrecte du téléviseur.



Pour éviter tout risque d'électrocution, n'utilisez pas cette fiche d'alimentation secteur polarisée avec une rallonge, une prise de courant ou avec une autre prise si les lames ne peuvent être introduites complètement afin d'éviter que des parties de lame ne restent exposées.



Vous êtes averti que tout changement ou modification non expressément approuvé dans le présent mode d'emploi peut invalider votre droit à utiliser cet appareil.

## AVIS

Cet appareil a été testé et approuvé en conformité avec les limites qui définissent un appareil numérique de classe B suivant la partie 15 des règlements du Centre de contrôle des fréquences (FCC). Ces limites sont conçues pour assurer une protection raisonnable pour une installation en résidence privée.

Cet appareil génère, utilise, et peut émettre, de l'énergie sur les fréquences radios, et, s'il n'est pas utilisé en suivant les instructions, peut causer des interférences nuisibles aux communications radio. Cependant, il n'y a pas de garantie qu'aucune interférence ne sera produite dans une installation particulière. Si cet appareil cause une interférence nuisible à la réception de la radio ou de la télévision, ce qu'on peut déterminer en éteignant et en rallumant l'appareil, l'utilisateur est encouragé à réduire l'interférence par les mesures suivantes :

- Ré-orienter ou déplacer les antennes réceptrices.
- Augmenter la distance entre l'appareil et le récepteur.
- Brancher l'appareil sur une prise différente de celle où est branché le récepteur.
- Consulter et se faire aider par le revendeur ou un technicien radio/télévision expérimenté.

## Protection du téléviseur

- Pour éviter toute surchauffe interne, évitez de boucher les orifices de ventilation.
- N'installez pas l'appareil dans un endroit surchauffé, trop humide, poussiéreux, ou soumis à des vibrations mécaniques excessives.

## Remarque sur l'affichage des sous-titres d'image

Ce téléviseur permet d'afficher les sous-titres d'image en accordance avec § 15.119 des règlements du Centre de contrôle des fréquences (FCC).

L'utilisation de ce téléviseur à d'autres fins qu'une vue par des particuliers des émissions transmises par les canaux UHF ou VHF ou par des sociétés de câble pour le grand public peut nécessiter l'accord de ces sociétés ou du propriétaire de l'émission.

## Références utilisateur

Les numéros de modèle et de série sont situés sur la couverture avant du présent mode d'emploi et à l'arrière du téléviseur.

## Marques commerciales et droits d'auteur

ENERGY STAR® est une marque déposée aux États-unis.



Comme associé au programme ENERGY STAR®, Sony a déterminé que ce produit ou ces modèles de produit satisfaisaient aux critères d'efficacité et de conservation de l'énergie posés par les directives ENERGY STAR®.

WEGA®, FD Trinitron et Caption Vision sont des marques de commerce déposées de Sony Corporation. Sous licence de BBE Sound, Inc., détenteur du brevet américain numéro 4638258.4482866. BBE et le symbole BBE sont des marques de commerce de BBE Sound, Inc.

WOW, TruSurround et le symbole (●)® sont des marques de commerce de SRS Labs, Inc. La technologie WOW est utilisée sous licence de SRS Labs, Inc.



# Consignes de sécurité importantes

Pour votre protection, veuillez lire entièrement ces instructions et les conserver à toutes fins utiles. Observez et respectez scrupuleusement tous les avertissements, précautions et instructions spécifiés sur l'appareil, ou décrits dans le mode d'emploi ou le manuel d'entretien.

## AVERTISSEMENT

Pour éviter tout risque de blessure, veuillez respecter les précautions de sécurité élémentaires suivantes lors de l'installation, l'utilisation et la réparation de l'appareil.

## Utilisation

### Sources d'alimentation

Cet appareil ne doit être alimenté que sur le type de source d'alimentation indiqué sur la plaque du numéro de série/modèle. Si vous n'êtes pas sûr du type d'alimentation électrique de votre domicile, consultez votre revendeur ou la société locale de distribution électrique. En ce qui concerne les appareils conçus pour fonctionner sur une alimentation par batterie, reportez-vous au mode d'emploi.



### Mise à la masse ou polarisation

Ce téléviseur peut être équipé d'une prise polarisée pour courant alternatif (une prise équipée de deux plots de largeur inégale). Cette prise ne peut être branchée sur le secteur que d'une seule façon. Il s'agit d'une fonction de sécurité. Si vous n'arrivez pas à brancher la prise complètement, retournez-la et essayez à nouveau. Si la prise ne peut toujours pas être branchée, contactez un électricien pour qu'il remplace la prise murale.

Ne désactivez pas la fonction de sécurité de la prise polarisée.

### Pour un appareil équipé d'une fiche d'alimentation secteur polarisée

Cette fiche ne se branche sur la prise secteur que d'une seule manière. C'est un dispositif de sécurité. Si vous ne parvenez pas à enfoncer la fiche à fond dans la prise, essayez de la retourner. Si la fiche ne correspond toujours pas, contactez votre électricien pour faire poser une prise adéquate. N'annulez pas le dispositif de sécurité de la prise polarisée en forçant dessus.



### Avertissement alternatif

### Pour un appareil équipé d'une fiche secteur à trois broches

Cette fiche ne peut être insérée que dans une prise secteur avec mise à la terre. C'est un dispositif de sécurité. Si vous ne parvenez pas à insérer la fiche dans la prise, contactez votre électricien pour faire poser une prise adéquate. N'annulez pas le dispositif de sécurité de la fiche de terre.

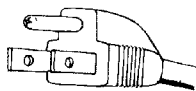

## Surcharge

Ne surchargez pas les prises murales, les rallonges ou autres prises de courant au-delà de leur capacité, car il y a risque d'incendie ou d'électrocution.

Mettez toujours l'appareil hors tension lorsqu'il n'est pas utilisé. Si vous n'avez pas l'intention de

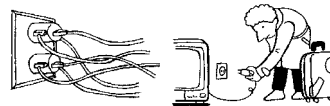

l'utiliser pendant longtemps, débranchez-le de la prise murale, par précaution, pour éviter la possibilité qu'une anomalie interne crée un début d'incendie.

Ne débranchez pas le câble d'antenne ou le cordon d'alimentation pendant un violent orage. La foudre pourrait en effet vous frapper alors que vous tenez le câble ou le cordon et vous causer ainsi de graves blessures. Mettez le téléviseur hors tension et attendez que l'orage passe.

## Pénétration d'un corps solide ou liquide

N'enfoncez jamais un objet quel qu'il soit dans le téléviseur par les fentes d'aération car il pourrait toucher des points de haute tension ou court-circuiter des pièces, et provoquer ainsi un incendie ou une électrocution. Ne renversez jamais de liquide quel qu'il soit dans l'appareil.



## Raccordements

N'utilisez pas de cordons qui ne sont pas recommandés par le fabricant, car ils pourraient être dangereux.

Ne posez pas d'objets, et tout spécialement des objets lourds sur le téléviseur. Ces objets pourraient tomber et vous blesser ou blesser une autre personne.



## Nettoyage

Débranchez la fiche de la prise murale avant de nettoyer ou de lustrer l'appareil.

N'utilisez pas de nettoyant liquide ou en vaporisateur. Nettoyez l'extérieur de l'appareil avec un chiffon légèrement humidifié à l'eau.



Si l'appareil produit continuellement ou fréquemment des bruits de claquement ou des bruits secs pendant son fonctionnement, débranchez-le et consultez votre revendeur ou un réparateur. Certains téléviseurs font entendre occasionnellement des bruits de claquement ou des bruits secs, en particulier au moment de la mise sous ou hors tension, mais c'est tout à fait normal.



## Installation

Demandez toujours l'assistance d'une autre ou de plusieurs autres personnes pour soulever ou déplacer le téléviseur. Le téléviseur est lourd et offre peu de prise dans sa partie inférieure. Vous pourriez vous blesser gravement si vous essayez de déplacer le téléviseur seul ou si vous le manipulez de manière instable.

Installez le téléviseur sur une surface stable et de niveau.

## Attention à l'eau et à l'humidité

N'utilisez pas un appareil alimenté sur le secteur près de lieux où se trouve de l'eau, comme une baignoire, un lavabo, un évier ou un bac à laver, dans un sous-sol humide ou près d'une piscine, etc.

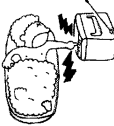

## Accessoires

Ne posez pas l'appareil sur un chariot, un support, une table ou une étagère instable. Il risque de tomber et de blesser gravement un enfant ou un adulte, et l'appareil risque d'être sérieusement endommagé. N'utilisez qu'un chariot ou un support recommandé par le fabricant pour ce modèle de téléviseur.

Pour déplacer un téléviseur placé sur un chariot, poussez-le avec précaution. L'ensemble chariot-téléviseur risque de se renverser en cas d'arrêt brusque, de poussée excessive ou de surface inégale.

Débranchez tous les câbles et tous les cordons avant d'essayer de déplacer le téléviseur.



Ne laissez pas des enfants ou des animaux domestiques monter sur le téléviseur ou le pousser. Le téléviseur pourrait en effet tomber, risquant ainsi de vous blesser sérieusement.

## Ventilation

Les fentes et les ouvertures aménagées sur le coffret et au dos ou au bas de l'appareil sont prévues pour la ventilation nécessaire. Pour assurer un fonctionnement fiable et pour protéger le téléviseur d'une surchauffe, ces fentes et ouvertures ne doivent jamais être bloquées ou recouvertes.

- Ne couvrez jamais les fentes et les ouvertures avec un chiffon ou autre morceau de tissu.



- Ne bloquez jamais les fentes et ouvertures en plaçant l'appareil sur un lit, un canapé, un tapis ou autre surface similaire.

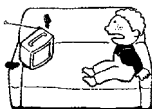

- N'encastrez jamais l'appareil dans un endroit fermé, comme une bibliothèque ou un meuble, sauf si une ventilation adéquate est assurée.



- Ne posez pas l'appareil sur ou près d'un radiateur ou d'un système de chauffage, ou dans un endroit exposé au soleil.



## Protection du cordon d'alimentation

Ne laissez jamais un objet rouler sur le cordon d'alimentation ou poser un objet lourd dessus. N'installez pas l'appareil dans un endroit où le cordon d'alimentation pourrait s'user prématurément ou être endommagé.



## Antennes

### Mise à la terre de l'antenne extérieure

Si vous installez une antenne extérieure, veuillez respecter les précautions ci-dessous. Une antenne extérieure ne doit pas être installée près de lignes électriques aériennes ou autres circuits d'alimentation ou d'éclairage électriques, ou dans un endroit où elle pourrait toucher de tels circuits ou lignes.

LORS DE L'INSTALLATION D'UNE ANTENNE EXTÉRIEURE, SOYEZ EXTRÊMEMENT PRUDENT POUR ÉVITER DE TOUCHER DE TELS CIRCUITS OU LIGNES ÉLECTRIQUES, CAR UN TEL CONTACT ENTRAÎNE PRATIQUEMENT TOUJOURS LA MORT.

L'antenne doit être reliée à la terre par mesure de sécurité contre les hausses brusques de tension et l'électricité statique accumulée. La section 810 du National Electrical Code (NEC) aux États-Unis et la section 54 du Code canadien de l'électricité fournissent des informations sur le raccordement à la terre correct du mât et de la structure porteuse, le raccordement de la descente d'antenne à une unité de déchargement d'antenne, la taille des conducteurs de mise à la terre, l'emplacement de l'unité de décharge d'antenne, la connexion aux électrodes de terre, et les spécifications des électrodes de terre.

## Mise à la terre de l'antenne conformément au NEC

Reportez-vous à la section 54-300 du Code canadien de l'électricité en ce qui concerne la mise à la terre de l'antenne.

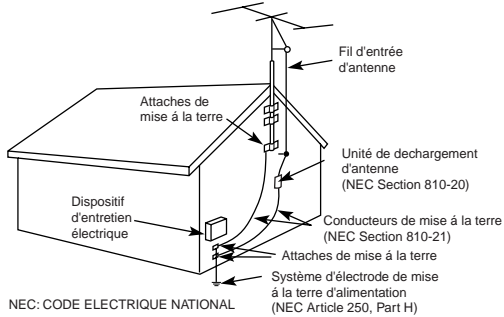

## Foudre

Pour une protection supplémentaire de cet appareil récepteur de télévision durant les orages accompagnés de foudre, ou lorsque l'appareil doit rester sans surveillance et sans usage pour des périodes prolongées, débranchez-le de sa prise murale et déconnectez l'antenne. Ceci évitera l'endommagement de l'appareil causé par la foudre et les surtensions.

## Dépannage

### Domages nécessitant un dépannage

Débranchez l'appareil de la prise murale et faites-le réparer par un réparateur qualifié dans les cas suivants:

- Le cordon ou la fiche d'alimentation est abîmé ou dénudé.
- Du liquide s'est renversé dans l'appareil ou des objets sont tombés dedans.
- L'appareil a été mouillé ou exposé à la pluie.
- L'appareil est tombé et a été cogné violemment, ou bien le coffret est abîmé.

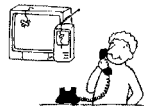
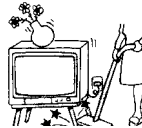
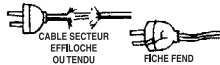

- L'appareil ne fonctionne pas normalement alors que vous avez respecté toutes les instructions du mode d'emploi. N'agissez que sur les commandes spécifiées dans le mode d'emploi. Tout réglage incorrect d'une autre commande risque d'endommager l'appareil et de nécessiter un important travail par un technicien qualifié pour le réparer.



- Une baisse sensible des performances indique que l'appareil a besoin d'être réparé.

## Réparation

N'essayez pas de réparer l'appareil vous-même; vous risquez d'être exposé à des hautes tensions dangereuses ou autres risques en ouvrant le coffret. Pour toute réparation, adressez-vous à un réparateur qualifié.



## Remplacement des pièces

Si des pièces doivent être remplacées, n'oubliez pas de demander au réparateur d'attester par écrit qu'il a utilisé des pièces de rechange spécifiées par le fabricant, avec les mêmes caractéristiques que les pièces originales. Toute substitution non autorisée peut être la cause d'un incendie, d'une électrocution ou autre danger.



## Révision de sécurité

A l'occasion de tout dépannage ou réparation de l'appareil, demandez au réparateur d'effectuer une révision de sécurité de routine (comme spécifié par le fabricant) pour déterminer si l'appareil offre une bonne sécurité de fonctionnement, et faites-le certifier par écrit. Lorsque l'appareil atteint la fin de sa vie utile, ne le jetez pas n'importe comment car il y a risque d'implosion du tube image. Demandez à un réparateur qualifié de vous en débarrasser.



# Table des matières

## Introduction

Caractéristiques du téléviseur couleur FD Trinitron WEGA® .....	1
À propos de ce mode d'emploi.....	2
Piles de la télécommande .....	2
Commandes de menu du panneau avant.....	2

## Utilisation de la télécommande

Description de la télécommande .....	3
Programmation de la télécommande.....	6
Utilisation de la télécommande du téléviseur avec d'autres appareils .....	8

## Raccordement du téléviseur

Panneau arrière du téléviseur .....	11
Raccordements de base.....	13
Raccordements avec un décodeur de câblodistribution .....	14
Raccordement d'autres appareils .....	16

## Utilisation des fonctions de base

Réglage automatique du téléviseur.....	25
Accès rapide aux menus .....	26
Utilisation de la fonction image sur image (PIP) .....	28
Raccordements qui affectent l'utilisation de la fonction image sur image (PIP) .....	30

## Utilisation des menus

Comment accéder aux menus.....	31
Utilisation du menu Vidéo .....	32
Utilisation du menu Audio .....	33
Utilisation du menu Canal .....	35
Utilisation du menu Parent .....	37
Contrôle parental.....	38
États-unis : sélection des options de classement spécifique.....	40
Canada: sélection des options de classement spécifique .....	42
Utilisation du menu Heure.....	43
Utilisation du menu Réglage.....	44
Utilisation du Menu de base .....	45

## Informations complémentaires

Guide de dépannage .....	47
Spécifications .....	52

<b>Index</b> .....	53
--------------------	----

# Introduction

Nous vous remercions d'avoir fait l'achat d'un téléviseur couleur FD Trinitron WEGA® de Sony.

## Caractéristiques du téléviseur couleur FD Trinitron WEGA®

Le téléviseur vous offre, entre autres, les fonctions suivantes :

- ❑ **Régulateur de haute tension** — Dispositif qui améliore de façon importante la qualité de l'image en augmentant la brillance et le foyer.
- ❑ **ÉCRAN PLAT FD Trinitron** — Tube image à la fine pointe de la technologie offrant une image d'une précision et d'une netteté exceptionnelles.
- ❑ **Entrées Y, P<sub>B</sub>, P<sub>R</sub>** — Raccordement d'entrées de composants vidéo fournissant une excellente qualité d'image (480i seulement).
- ❑ **WOW** — Fonction audio produisant un son spectaculaire avec des graves puissantes et profondes. Lorsque la fonction WOW est activée, BBE est également activée automatiquement pour améliorer encore davantage la qualité sonore.
- ❑ **TruSurround** — Production d'un son tridimensionnel dynamique à partir de signaux sonores stéréo.
- ❑ **BBE** — Grâce à la technologie audio utilisée pour compenser les effets de phase dans les haut-parleurs, il procure un son offrant plus d'impact.
- ❑ **Contrôle parental (V-Chip)** — Outil aidant les parents à contrôler les émissions que leurs enfants regardent en définissant des limites de classement.
- ❑ **ClearEdge VM** — Augmente la définition de l'image et donne aux objets un contour précis et net.
- ❑ **DynaBlack** — Améliore le contraste et la précision des détails de l'image.
- ❑ **Fonction image sur image (PIP)** — Permet de visionner deux émissions en même temps.
- ❑ **Canaux préférés** — Accès immédiat à vos canaux préférés en appuyant sur une touche.
- ❑ **Bannière info** — Fonction pratique permettant d'afficher le nom et la durée restante du programme en cours, lorsque ces informations sont disponibles.
- ❑ **Télécommande universelle** — Programmez votre télécommande pour faire fonctionner le décodeur, le magnétoscope, le récepteur satellite numérique ou le lecteur DVD raccordé.
- ❑ **Energy Star®** — Cet appareil satisfait les critères Energy Star en matière d'économie d'énergie.
- ❑ **Commandes du panneau avant** — Permettent d'accéder aux menus d'écran sans la télécommande.
- ❑ **Entrées A/V avant** — Connexion rapide des consoles de jeux vidéo, des caméscopes, ou des appareils stéréo/mono.

## À propos de ce mode d'emploi

Le présent mode d'emploi fournit des instructions qui vous permettront d'exploiter au mieux votre nouveau téléviseur. Il décrit comment le raccorder à une antenne ou au réseau câblé, à un décodeur, un magnétoscope, un lecteur DVD, un récepteur satellite, une chaîne stéréo ou un caméscope. Lorsque les connexions ont été établies, suivez les instructions et utilisez la télécommande pour accéder aux menus affichés à l'écran.

## Piles de la télécommande

Insérez deux piles AA (R6) (fournies) dans la télécommande en suivant les instructions de l'illustration ci-dessous.

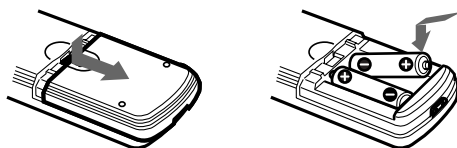



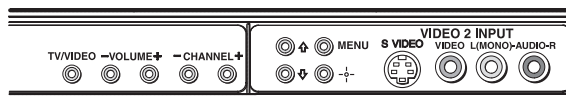

 Dans des conditions d'utilisation normales, les piles durent six mois. Si la télécommande ne fonctionne pas correctement, les piles peuvent être à plat.

 Si vous n'utilisez pas la télécommande pendant une durée prolongée, retirez les piles afin d'éviter les dommages qui peuvent être causés par une fuite des piles.

## Commandes de menu du panneau avant



Les commandes du panneau audio/vidéo avant permettent d'accéder au menu sans la télécommande.

- Appuyez sur  pour afficher le menu à l'écran.
- Utilisez les touches  et  du panneau avant au lieu des touches de la télécommande.
- Utilisez la touche  du panneau audio/vidéo avant pour naviguer dans les menus, puis sélectionnez un paramètre.

Les commandes du panneau avant permettent également de changer de canal (CH+/-), de régler le volume (VOL +/-) et de modifier les entrées vidéo.

 Reportez-vous à la section " Utilisation des menus ", page 31 pour naviguer entre les menus avec votre télécommande.



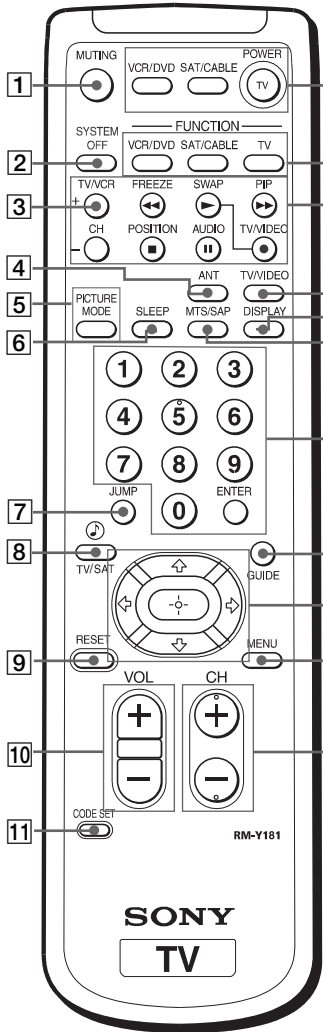

# Utilisation de la télécommande

## Description de la télécommande

	Touche	Description
	<b>1 MUTING</b>	Appuyez sur cette touche pour désactiver le son. Appuyez de nouveau ou appuyez sur $\text{VOL} \left[ \begin{smallmatrix} \text{VOL} \\ + \end{smallmatrix} \right]$ pour réactiver le son.
	<b>2 SYSTEM OFF</b>	Appuyez sur cette touche pour mettre hors tension les appareils programmés dans la télécommande. Voir la section "Programmation de la télécommande" à la page 6.
	<b>3 TV/VCR</b>	Appuyez sur cette touche pour passer du mode téléviseur au mode magnéto-scope et vice-versa. Si le magnéto-scope n'est pas de marque Sony, il est nécessaire de programmer la télécommande pour qu'elle reconnaisse le magnéto-scope. Pour plus de détails, voir "Programmation de la télécommande" à la page 6.
	<b>4 ANT (antenne)</b>	Appuyez sur cette touche pour changer la source entre l'entrée VHF/UHF et l'entrée AUX. Appuyez une autre fois pour changer à la position antérieure.
	<b>5 PICTURE MODE</b>	Appuyez plusieurs fois sur cette touche pour passer en revue les modes image disponibles : éclatant, standard, film et pro. Cette fonction est également offerte dans le menu Vidéo. Pour plus de détails, voir "Utilisation du menu Vidéo" à la page 32.
	<b>6 SLEEP</b>	Appuyez plusieurs fois sur cette touche jusqu'à ce que le délai souhaité avant la mise hors tension automatique du téléviseur (15, 30, 45, 60 ou 90 minutes) s'affiche à l'écran. Pour annuler, appuyez sur cette touche jusqu'à ce que "Sleep Non" s'affiche. Si la fonction Sleep est active, appuyez une fois sur la touche pour connaître le temps qu'il reste avant que le téléviseur s'éteigne.
	<b>7 JUMP</b>	Appuyez sur cette touche pour sauter d'un canal à un autre. Le téléviseur alternera entre le canal courant et le dernier canal sélectionné. La touche JUMP ne fonctionne pas si un mode FONCTION (VCR/DVD, SAT/CABLE, TV) est activé.



Touche	Description
<b>8</b> TV/SAT	Appuyez sur cette touche pour passer de l'entrée téléviseur (TV) à l'entrée satellite (SAT), et vice-versa, en mode FUNCTION SAT.
	Appuyez sur cette touche pour sélectionner directement le réglage "Effet" (Simulé, WOW, TruSurround, Non) lorsque la télécommande est en mode FUNCTION TV. Pour plus de détails, voir "Utilisation du menu Audio" à la page 33.
<b>9</b> RESET	Appuyez sur cette touche pour réinitialiser les réglages d'origine du téléviseur pendant l'affichage d'un menu à l'écran.
<b>10</b> VOL (volume)	Appuyez sur (+) ou (-) pour régler le volume.
<b>11</b> CODE SET	Utilisez cette touche pour programmer la télécommande afin de commander un appareil vidéo raccordé. Voir "Programmation de la télécommande" à la page 6.
<b>12</b> Touches POWER	Appuyez sur ces touches pour allumer et éteindre le téléviseur et les autres appareils audio et vidéo raccordés programmés dans la télécommande. Pour les directives, reportez-vous à la section "Programmation de la télécommande" à la page 6.
<b>13</b> Touches FUNCTION	Appuyez sur l'une de ces touches pour sélectionner l'appareil à commander avec la télécommande (TV, VCR/DVD, SAT/CABLE). Le voyant (DEL) s'allume momentanément lorsque la touche est enfoncée pour indiquer l'appareil commandé par la télécommande.
<b>14</b> PIP (image sur image)	Appuyez sur cette touche pour utiliser la fonction PIP. Voir "Utilisation de la fonction image sur image (PIP)" à la page 28.
VCR (commande)	Appuyez sur cette touche pour commander votre magnétoscope. Le magnétoscope doit être programmé dans la télécommande. Pour les directives, reportez-vous à la section "Programmation de la télécommande" à la page 6.
● et ► (pour enregistrer)	Appuyez simultanément sur la touche ● et sur la touche ►, pour lancer l'enregistrement de n'importe quelle émission avec votre magnétoscope (la télécommande doit être programmée pour que l'enregistrement fonctionne).
◀◀	Appuyez sur cette touche pour rebobiner.

Touche	Description
	Appuyez sur cette touche pour avancer rapidement.
	Appuyez sur cette touche pour lancer la lecture.
	Appuyez sur cette touche pour arrêter la bande.
	Appuyez sur cette touche pour faire une pause de lecture. Appuyez de nouveau pour revenir à la lecture normale.
<b>15 TV/VIDEO</b>	Appuyez sur cette touche pour passer d'une source vidéo à l'autre.
<b>16 DISPLAY</b>	Appuyez une fois sur cette touche pour afficher l'heure (si réglée), le numéro du canal, l'identification du canal (si définie), la source vidéo et l'identification vidéo. Appuyez de nouveau pour désactiver l'affichage.
<b>17 MTS/SAP</b>	Appuyez sur cette touche pour faire défiler les options de la fonction Son TV multicanal (MTS) : Stéréo, Auto SAP (bande sonore secondaire) et Mono.
<b>18 0-9 et ENTER</b>	Appuyez sur ces touches pour passer directement à un autre canal. Le canal change après deux secondes.
<b>19 GUIDE</b>	Appuyez sur cette touche pour afficher le guide de programmation de votre service de télé par satellite.
<b>20</b> 	Appuyez sur les touches fléchées pour déplacer le curseur dans les menus à l'écran. Appuyez sur la touche du centre pour sélectionner ou valider une option.
<b>21 MENU</b>	Appuyez sur cette touche pour afficher le menu à l'écran. Pour quitter le menu, appuyez de nouveau sur cette touche, à n'importe quel moment.
<b>22 CH (canal)</b>	Appuyez sur ces touches pour changer de canal. Pour passer rapidement les canaux en revue, maintenez enfoncée la touche CH+ ou CH-.





 Pour connaître les touches de commande de la fonction image sur image (PIP), voir page 28.



 Si vous perdez votre télécommande, reportez-vous à la page 48.

## Programmation de la télécommande



Vous pouvez utiliser la télécommande fournie pour contrôler d'autres appareils. Suivez la procédure ci-dessous pour programmer la télécommande.

- 1 Consultez la liste des "Codes des fabricants" à la page 7 pour trouver le code à trois chiffres du fabricant de votre composante. S'il y a plus d'un numéro de code, utilisez le numéro apparaissant en premier.
- 2 Appuyez sur .

 Les touches  et  clignotent lorsque vous appuyez sur .

- 3 Appuyez sur  ou sur  la touche pour indiquer le type de composante que vous désirez programmer avec la télécommande.

 Vous devez effectuer l'étape 4 dans les 10 secondes suivant l'étape 3, sinon vous devrez recommencer les étapes 2 et 3.

- 4 Utilisez les touches - pour saisir le numéro de code à partir du tableau suivant.
- 5 Appuyez sur .
- 6 Pour vérifier si le numéro de code fonctionne, pointez la télécommande du téléviseur en direction de la composante et appuyez sur la touche verte POWER qui correspond à cette composante. S'il y a une réponse, vous avez terminé. Sinon, essayez un autre code indiqué pour ce fabricant.

 Si vous avez de la difficulté à programmer votre télécommande, consultez la section "Informations complémentaires" à la page 47.

## Codes des fabricants

### Magnétoscopes

<b>Fabricant</b>	<b>Code</b>
Sony	301, 302, 303
Admiral (M. Ward)	327
Aiwa	338, 344
Audio Dynamic	314, 337
Broksonic	319, 317
Canon	309, 308
Citizen	332
Craig	302, 332
Criterion	315
Curtis Mathes	304, 338, 309
Daewoo	341, 312, 309
DBX	314, 336, 337
Dimensia	304
Emerson	319, 320, 316, 317, 318, 341
Fisher	330, 335
Funai	338
General Electric	329, 304, 309
Go Video	322, 339, 340
Goldstar	332
Hitachi	306, 304, 305, 338
Instant Replay	309, 308
JC Penney	309, 305, 304, 330, 314, 336, 337
JVC	314, 336, 337, 345, 346, 347
Kenwood	314, 336, 332, 337
LXI (Sears)	332, 305, 330, 335, 338
Magnavox	308, 309, 310
Marantz	314, 336, 337
Marta	332
Memorex	309, 335
Minolta	305, 304
Mitsubishi/ MGA	323, 324, 325, 326
Multitech	325, 338, 321
NEC	314, 336, 337
<b>Fabricant</b>	<b>Code</b>
Olympic	309, 308
Optimus	327

Panasonic	308, 309, 306, 307
Pentax	305, 304
Philco	308, 309
Philips	308, 309, 310
Pioneer	308
Quasar	308, 309, 306
RCA/ PROSCAN	304, 305, 308, 309, 311, 312, 313, 310, 329
Realistic	309, 330, 328, 335, 324, 338
Sansui	314
Samsung	322, 313, 321
Sanyo	330, 335
Scott	312, 313, 321, 335, 323, 324, 325, 326
Sharp	327, 328
Shintom	315
Signature 2000 (M. Ward)	338, 327
SV2000	338
Sylvania	308, 309, 338, 310
Symphonic	338
Tashiro	332
Tatung	314, 336, 337
Teac	314, 336, 338, 337
Technics	309, 308
Toshiba	312, 311
Wards	327, 328, 335, 331, 332
Yamaha	314, 330, 336, 337
Zenith	331

### Codes des lecteurs de disque laser

<b>Fabricant</b>	<b>Code</b>
Sony	701
Panasonic	704, 710
Pioneer	702

### Codes des lecteurs de DVD

<b>Fabricant</b>	<b>Code</b>
Sony	751
Hitachi	758

JVC	756
Magnavox	757
Mitsubishi	761
Oritron	759
Panasonic	753
Philips	757
Pioneer	752
RCA	755
Samsung	758
Toshiba	754
Zenith	760

### Codes des décodeurs









<b>Fabricant</b>	<b>Code</b>
Sony	230
Hamlin/Regal	222, 223, 224, 225, 226
Jerrold/G.I./ Motorola	201, 202, 203, 204, 205, 206, 207, 208, 218
Oak	227, 228, 229
Panasonic	219, 220, 221
Pioneer	214, 215
Scientific Altanta	209, 210, 211
Tocom	216, 217
Zenith	212, 213

### Codes des récepteurs satellite



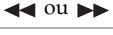





<b>Fabricant</b>	<b>Code</b>
Sony	801
DIRECT TV	809
Dish Network	810
Echostar	810
General Electric	802
Hitachi	805
Hughes	804
Mitsubishi	809
Panasonic	803
RCA/ PROSCAN	802, 808
Toshiba	806, 807

## Utilisation de la télécommande du téléviseur avec d'autres appareils





### Fonctionnement d'un magnétoscope

Appuyer sur	Pour
	Mettre le magnétoscope sous tension (touche verte VCR/DVD)
	Sélectionner directement des canaux
	Changer de canaux
	Lire une cassette vidéo
	Arrêter
	Faire une recherche vers l'avant ou l'arrière
	Faire une pause
	Enregistrer
	Basculer entre les entrées du magnétoscope et du téléviseur









### Fonctionnement d'un lecteur DVD

Appuyer sur	Pour
	Mettre le DVD sous tension (touche verte VCR/DVD)
	Sélectionner des chapitres directement
	Rechercher des chapitres vers l'avant ou l'arrière
	Lire un DVD
	Arrêter
	Faire une pause
	Afficher le menu DVD
	Utiliser les touches fléchées pour déplacer le curseur dans le menu et la touche du centre pour sélectionner une option





### Fonctionnement d'un lecteur de disque laser

Appuyer sur	Pour
	Mettre le lecteur de disque laser sous tension (touche verte VCR/DVD)
	Rechercher des chapitres vers l'avant ou l'arrière
	Lire un disque
	Arrêter
	Faire une pause

## Fonctionnement d'un récepteur satellite

Appuyer sur	Pour
	Mettre le récepteur satellite sous tension (touche verte SAT/CABLE)
	Sélectionner directement des canaux
	Changer de canaux
	Revenir au canal précédent
	Afficher le numéro du canal
	Afficher le guide de programmation du service télé par satellite
	Afficher le menu du satellite
	Utiliser les touches fléchées pour déplacer le curseur dans le menu et la touche du centre pour sélectionner une option

## Fonctionnement d'un décodeur

Appuyer sur	Pour
	Mettre la boîte de câblodistribution sous tension (touche verte SAT/CABLE)
	Sélectionner directement des canaux
	Changer de canaux
	Revenir au canal précédent

# Raccordement du téléviseur

Lisez cette section avant de configurer votre téléviseur pour la première fois. Elle traite les raccordements de base, en plus des appareils en option que vous raccorderez éventuellement.

## Panneau arrière du téléviseur

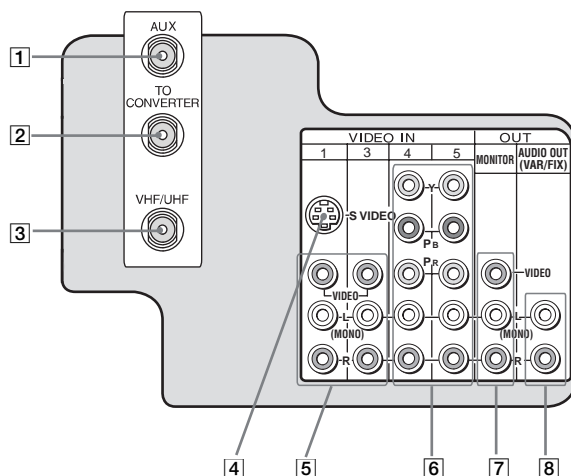

Prise	Description
<b>1</b> AUX	Prise permettant de visionner les canaux locaux et ceux du câble si le câblodistributeur n'offre pas les canaux locaux. Appuyez sur la touche ANT de la télécommande pour passer facilement des canaux locaux à ceux du câble. Les images provenant d'appareils raccordés à l'entrée AUX ne peuvent pas être visionnées avec la fonction image sur image (PIP).
<b>2</b> TO CONVERTER	Prise de sortie VHF/UHF permettant de raccorder le téléviseur pour pouvoir passer des canaux brouillés (provenant d'un décodeur) aux canaux normaux du câble (CATV) et vice-versa. Utilisez cette prise au lieu d'un répartiteur pour obtenir une image de meilleure qualité si vous devez passer des canaux de câblodistribution brouillés à des canaux de câblodistribution non brouillés.
<b>3</b> VHF/UHF	Prise permettant de raccorder votre câble ou votre antenne VHF/UHF.



Prise	Description
4 S VIDEO	Prise permettant un raccordement avec la prise S VIDEO OUT de votre magnétoscope ou d'un autre appareil vidéo possédant une prise S VIDEO. La prise S VIDEO fournit une image de meilleure qualité que les prises VHF/UHF ou que la prise d'entrée vidéo. La prise S VIDEO ne fournit aucun son. Les câbles audio doivent rester raccordés.
5 AUDIO L(MONO), R/VIDEO	Prise permettant le raccordement aux prises de sortie AUDIO/VIDEO du magnétoscope ou d'un autre appareil vidéo. Une troisième prise d'entrée vidéo (VIDEO 2) est située sur le panneau avant du téléviseur. Ces prises d'entrée AUDIO/VIDEO offrent une image de meilleure qualité que la prise VHF/UHF.
6 Y, PB, PR/ L(MONO), R	Prises (Video 4-5) permettant le raccordement sur les composants vidéos Y, P <sub>B</sub> , P <sub>R</sub> vers les prises AUDIO L et R de votre lecteur DVD ou décodeur numérique (480i uniquement).
7 MONITOR OUT	Prise permettant l'enregistrement, avec un magnétoscope, d'une émission en cours de visionnement. Lorsque deux magnétoscopes sont raccordés, (voir "Raccordement de deux magnétoscopes pour le montage de cassettes" à la page 23), le téléviseur peut servir de moniteur pour le montage de cassette à cassette.
8 AUDIO OUT (VAR/FIX) L(MONO)/R	Prise se raccordant aux prises d'entrée audio de votre appareil audio. Vous pouvez écouter le son du téléviseur par l'intermédiaire de votre chaîne stéréo.

## Raccordements de base

### Antenne de télévision intérieure ou extérieure ou câble CATV

Selon le câble disponible chez vous, choisissez l'un des raccordements suivants :

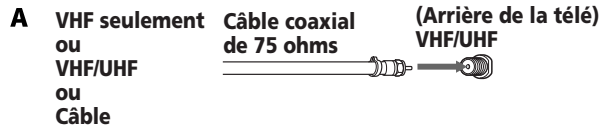

Utilisez ce type de raccordement pour relier le téléviseur à un système de câblodistribution ou à une antenne avec un câble de 75 ohms (habituellement intégré dans les résidences plus récentes).

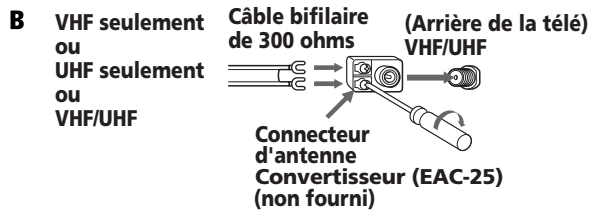

Utilisez ce type de raccordement pour relier le téléviseur à une antenne doublet, communément appelée "oreilles de lapin", (habituellement installé dans les résidences moins récentes).

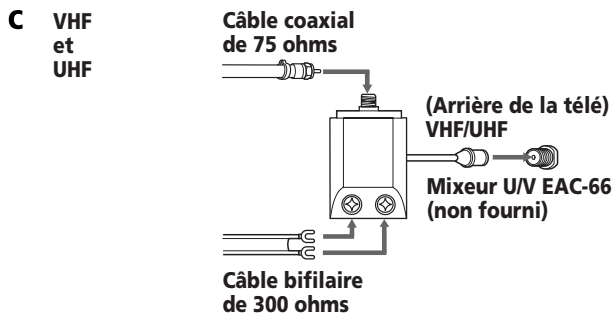

Ce raccordement vous permet de relier le téléviseur à la fois à un système de câblodistribution et à une antenne doublet. Vous avez ainsi accès aux canaux sur le câble et aux canaux locaux.

 Si vous vous raccordez sur une antenne intérieure ou extérieure, vous devrez éventuellement ajuster l'orientation de l'antenne pour améliorer la réception.

## Raccordements avec un décodeur de câblodistribution

Certains services de câblodistribution transmettent des signaux brouillés ou encodés pour tous les canaux. Un décodeur est alors requis pour la réception. Si vous êtes abonné à un service de ce type, utilisez le raccordement ci-dessous. Les images brouillées traitées par le décodeur ne peuvent pas être visionnées avec la fonction image sur image (PIP). Si certains des canaux reçus sont brouillés et que d'autres sont reçus directement, il peut être préférable d'utiliser le raccordement décodeur et câblodistribution.

### Décodeur et téléviseur

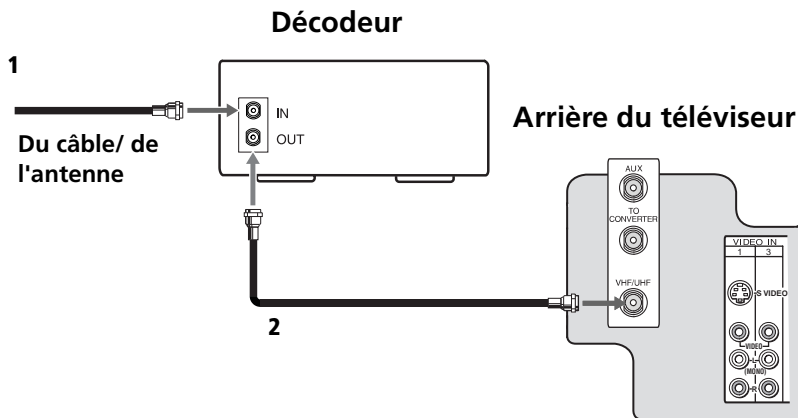

- 1** Raccordez le câble coaxial du câblodistributeur sur la prise IN du décodeur.
- 2** Raccordez un câble coaxial (non fourni) entre la prise OUT du décodeur et la prise VHF/UHF du téléviseur.

### Utilisation de votre téléviseur avec ce raccordement

Ce raccordement vous permet de faire les actions suivantes:

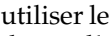
- ❑ Programmer votre télécommande Sony de façon à contrôler votre décodeur (voir la page 6).
- ❑ Pour activer votre télécommande, appuyer sur  pour contrôler le décodeur, puis utiliser les  touches ou les touches CH+/- pour changer de canal. Pour ce faire, vous devez d'abord programmer votre télécommande, puis utiliser la fonction Canal fixe pour placer votre téléviseur au canal 3 ou 4 (voir la page 36).

## Décodeur et câble

Choisissez ce raccordement si votre service de câble transmet certains canaux brouillés (télévision payante) et d'autres canaux non brouillés. Ce type d'installation permet d'utiliser la télécommande pour :

- ❑ changer de canal par l'entremise du décodeur lors de la réception de canaux brouillés;
- ❑ changer de canal par l'entremise du téléviseur.

Ce raccordement permet également d'utiliser la fonction image sur image (PIP) lors du visionnement de canaux de câble non brouillés transmis directement au téléviseur. Les images brouillées reçues par l'entremise du décodeur câble ne peuvent pas être visionnées avec la fonction image sur image. Pour plus de détails sur la fonction image sur image (PIP), consultez la page 28.

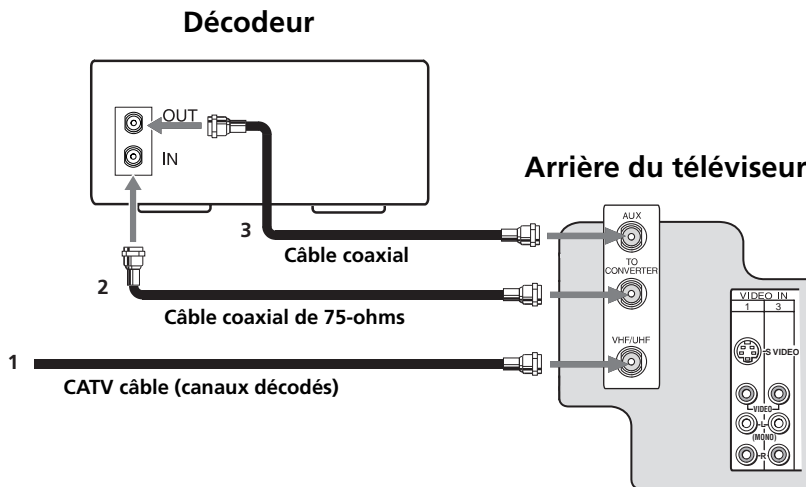

 **UTILISATEURS DE DÉCODEURS NUMÉRIQUES :** N'utilisez pas ce raccordement. La prise TO CONVERTER n'est pas compatible avec les décodeurs numériques.



- 1** Raccordez le câble coaxial du câblodistributeur sur la prise VHF/UHF du téléviseur.
- 2** Avec un câble coaxial (non fourni), raccordez la prise IN du décodeur à la prise TO CONVERTER du téléviseur.
- 3** Avec un câble coaxial (non fourni), raccordez la prise OUT du décodeur à la prise AUX du téléviseur.

### Utilisation de votre téléviseur avec ce raccordement

Ce raccordement vous permet de faire les actions suivantes:

- ❑ Programmer votre télécommande Sony de façon à contrôler votre décodeur (voir la page 6).
- ❑ Pour activer votre télécommande, appuyer sur  pour contrôler le décodeur, puis utiliser les touches ①-⑨ ou les touches CH+/- pour changer de canal. Pour ce faire, vous devez d'abord programmer votre télécommande, puis utiliser la fonction Canal fixe pour placer votre téléviseur au canal 3 ou 4 (voir la page 36).
- ❑ Appuyer sur  pour passer de VHF/UHF (canaux locaux et non brouillés) à AUX (système de câblodistribution ou canaux payants) et vice-versa.

## Raccordement d'autres appareils

### Raccordement du téléviseur à un magnétoscope

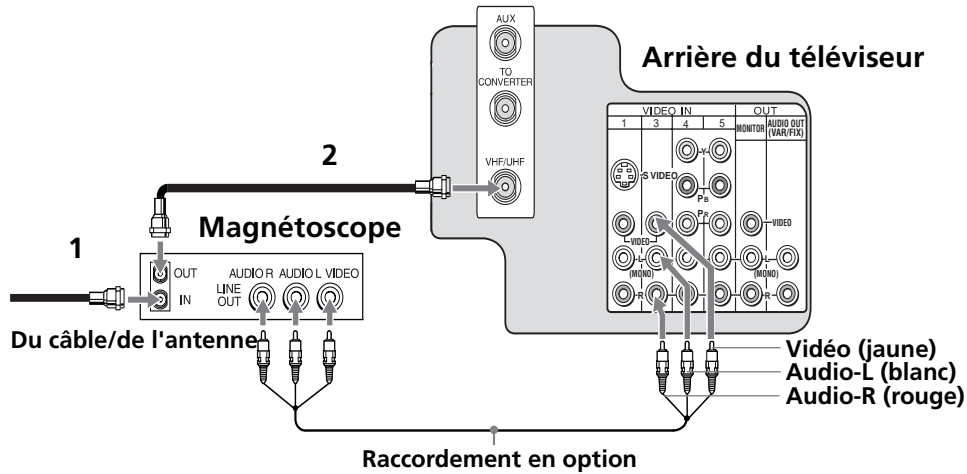

- 1** Raccordez le câble coaxial entre l'antenne de télévision ou le câble et la prise IN du magnétoscope.
- 2** Raccordez un câble coaxial (non fourni) entre la prise OUT du magnétoscope et la prise VHF/UHF du téléviseur.

#### Raccordement facultatif

- ❑ Si votre magnétoscope est doté de prises de sortie vidéo, vous obtiendrez une meilleure qualité d'image en connectant les câbles audio/vidéo (non fournis) de la prise AUDIO/VIDEO OUT de votre magnétoscope à la prise AUDIO/VIDEO IN de votre téléviseur.
- ❑ Pour obtenir une meilleure qualité d'image, utilisez S VIDEO plutôt que le câble vidéo jaune. S VIDEO ne procure pas de son, vous devez donc quand même brancher les câbles audio.

#### Utilisation de votre téléviseur avec ce raccordement

Ce raccordement vous permet de faire les actions suivantes :

- ❑ Programmer votre télécommande Sony de façon à contrôler votre décodeur (voir page 6).
- ❑ Pour activer votre télécommande, appuyez sur pour contrôler votre magnétoscope. Pour ce faire, vous devez d'abord programmer votre télécommande, puis utiliser la fonction Canal fixe pour placer votre téléviseur au canal 3 ou 4 (voir la page 36).
- ❑ Appuyez sur pour passer de l'entrée VIDÉO à VHF/UHF (canaux locaux) et vice-versa.

## Raccordement d'un téléviseur, d'un magnéto et d'un décodeur

Choisissez ce raccordement si votre service de câblodistribution transmet certains canaux brouillés (télévision payante) et d'autres canaux directement. Ce type d'installation permet d'utiliser la télécommande pour :

- ❑ changer de canal par l'entremise du décodeur ou du magnéto lors de la réception des canaux brouillés;
- ❑ changer de canal par l'entremise du téléviseur.

Ce raccordement permet également d'utiliser la fonction image sur image (PIP) lors du visionnement de canaux de câblodistribution non brouillés transmis directement au téléviseur. Les images brouillées reçues par l'entremise du décodeur ne peuvent pas être visionnées avec la fonction image sur image. Pour plus de détails sur la fonction image sur image (PIP), voir page 28.

 **UTILISATEURS DE DÉCODEURS NUMÉRIQUES :** Si vous branchez un décodeur numérique, vous aurez besoin d'un répartiteur bidirectionnel spécial compatible avec votre décodeur numérique.

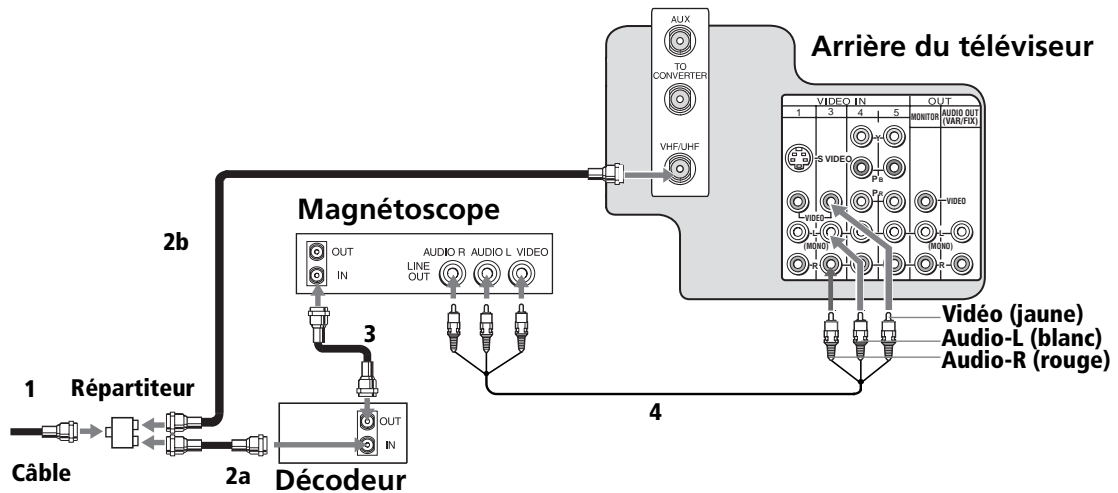

- 1** Raccordez le câble de câblodistribution à la prise simple (entrée) du répartiteur.
- 2** À l'aide de câbles coaxiaux (non fournis), raccordez chacune des deux prises de sortie du répartiteur à :
  - a)** la prise d'entrée (IN) du décodeur;
  - b)** la prise VHF/UHF du téléviseur.
- 3** Avec un câble coaxial (non fourni), raccordez la prise OUT du décodeur à la prise IN du magnéto.
- 4** Si votre magnéto est doté de prises de sortie vidéo, vous obtiendrez une meilleure qualité d'image en connectant les câbles audio/vidéo (non fournis) de la prise AUDIO/VIDEO OUT de votre magnéto à la prise AUDIO/VIDEO IN de votre téléviseur.



(suite)

 UTILISATEURS DE DÉCODEURS NUMÉRIQUES : N'utilisez pas ce raccordement. La prise TO CONVERTER n'est pas compatible avec les décodeurs numériques.

### Raccordement facultatif

- ❑ Pour obtenir une meilleure qualité d'image, utilisez S VIDEO plutôt que le câble vidéo jaune. S VIDEO ne procure pas de son, vous devez donc quand même brancher les câbles audio.

### Utilisation de votre téléviseur avec ce raccordement

- ❑ Programmer votre télécommande Sony de façon à contrôler votre magnétoscope ou votre décodeur (voir page 6).
- ❑ Pour activer votre télécommande, appuyer sur  pour contrôler votre magnétoscope  votre décodeur. Pour ce faire, vous devez d'abord programmer votre télécommande, puis utiliser la fonction Canal fixe pour placer votre téléviseur au canal 3 ou 4 (voir la page 36).
- ❑ Appuyer sur  pour passer de l'entrée VIDÉO à VHF/UHF (canaux locaux ou non brouillés) au décodeur (système de câblodistribution ou canaux brouillés).



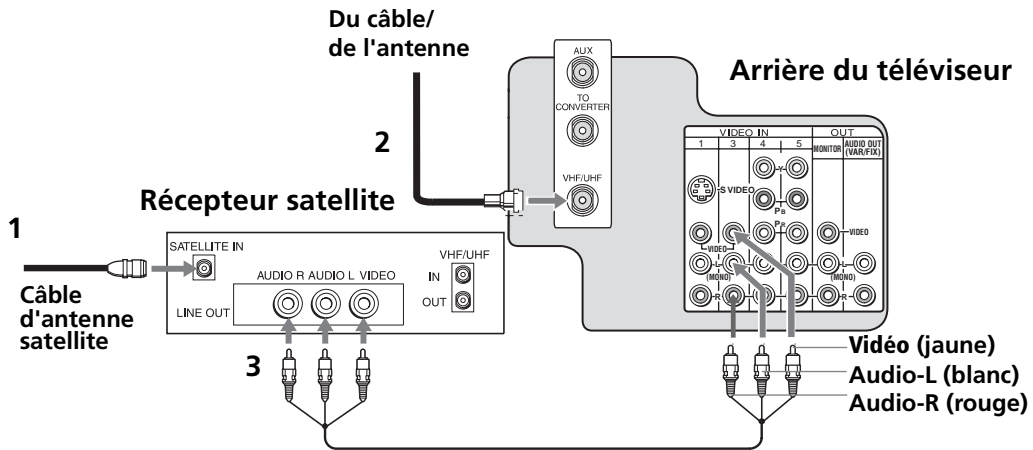

## Raccordement du téléviseur à un récepteur satellite



- 1** Raccordez le câble entre l'antenne satellite et la prise SATELLITE IN du récepteur satellite.
- 2** Raccordez le câble coaxial de votre service du câble ou de l'antenne sur la prise VHF/UHF du téléviseur.
- 3** Raccordez les prises AUDIO et VIDEO OUT du récepteur satellite sur les prises AUDIO et VIDEO IN du téléviseur à l'aide de câbles audio/vidéo (non fournis).

## Utilisation de votre téléviseur avec ce raccordement

Ce raccordement vous permet de faire les actions suivantes :

- ❑ Programmer votre télécommande Sony de façon à contrôler votre récepteur de signaux de satellite (voir page 6).
- ❑ Pour activer votre télécommande, appuyer sur  pour contrôler le récepteur de signaux de satellite. Consulter la page 8 pour savoir comment utiliser les autres fonctions.
- ❑ Appuyer  plusieurs fois sur pour passer à l'entrée du récepteur de signaux de satellite (entrée VIDEO).

## Raccordement du téléviseur à un récepteur satellite et à un magnéto

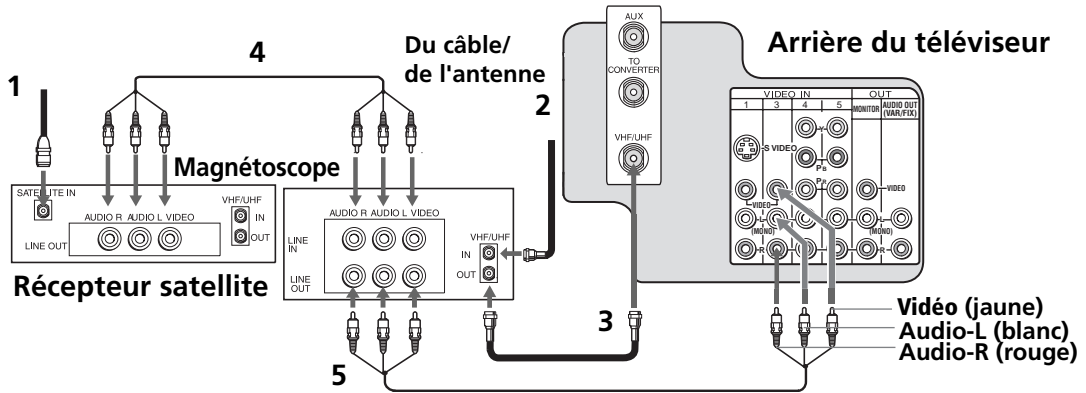

- 1 Raccordez le câblecoaxial de votre antenne satellite à SATELLITE IN sur votre récepteur satellite.
- 2 Raccordez le câble coaxial de votre câblodistributeur ou de l'antenne dans la prise IN de votre magnéto.
- 3 À l'aide d'un câble coaxial (non fourni), raccordez la prise OUT sur votre magnéto à la prise VHF/UHF sur votre téléviseur.
- 4 À l'aide de câbles audio/vidéo (non fournis), raccordez AUDIO/ VIDEO OUT de votre récepteur satellite à AUDIO/VIDEO IN sur votre magnéto.
- 5 À l'aide de câbles audio/vidéo (non fournis), raccordez AUDIO/ VIDEO OUT sur votre magnéto à AUDIO/VIDEO IN sur votre téléviseur.

Pour obtenir des images depuis le récepteur satellite ou le magnéto, sélectionnez l'entrée vidéo sur laquelle le récepteur satellite ou le magnéto est raccordé en appuyant sur la touche de la télécommande.

### Utilisation de votre téléviseur avec ce raccordement

Ce raccordement vous permet de faire les actions suivantes :

- ❑ Programmer votre télécommande Sony de façon à contrôler votre magnéto ou votre récepteur de signaux de satellite (voir page 6).
- ❑ Mettre votre magnéto sous tension pour permettre au récepteur de signaux de satellite de fonctionner avec ce raccordement.
- ❑ Pour activer votre télécommande, appuyer sur pour contrôler votre magnéto ou votre récepteur de signaux de satellite.
- ❑ Appuyer sur pour passer de l'entrée VIDÉO à VHF/UHF (canaux locaux ou non brouillés) au décodeur (système de câblodistribution ou canaux brouillés).

## Raccordement d'un lecteur DVD

Raccordez les prises AUDIO et VIDEO OUT du lecteur DVD sur les prises AUDIO et VIDEO IN du téléviseur à l'aide de câbles audio/vidéo (non fournis).

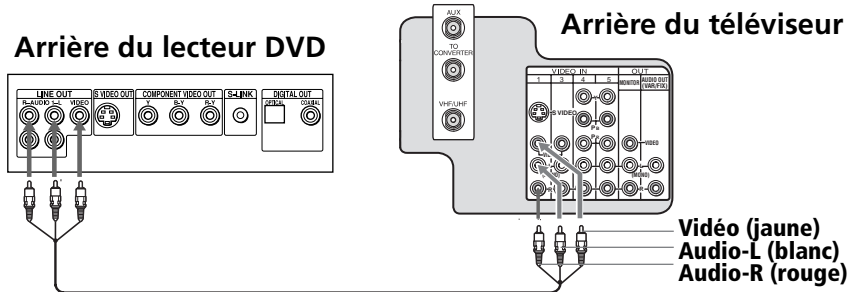

### Raccordement facultatif

- ❑ Pour obtenir une meilleure qualité d'image, utilisez S VIDEO plutôt que le câble vidéo jaune. S VIDEO ne procure pas de son, vous devez donc quand même brancher les câbles audio.
- ❑ Si votre lecteur DVD est muni de sorties vidéo (Y, PB, PR), vous pouvez améliorer la qualité de l'image en utilisant les câbles vidéo (480i seulement). Vous pouvez faire ce raccordement sur VIDEO 4 ou 5 (à la fois (Y, PB, PR).

La fonction PIP n'est pas compatible à VIDEO 4-5. Vous pouvez utiliser VIDEO 1 or 3. Ces entrées sont compatibles à PIP.

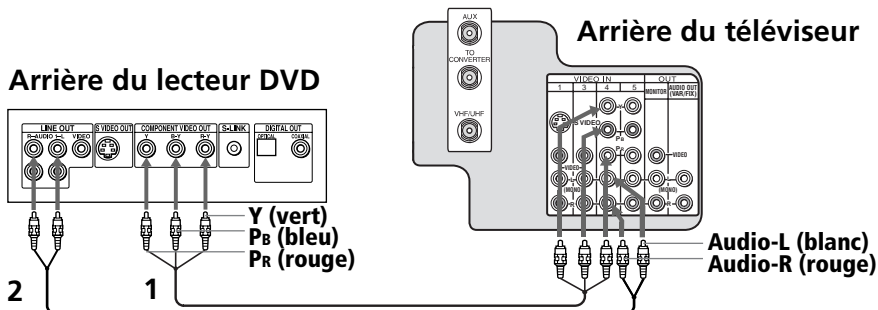

- 1 Raccordez les prises Y, P<sub>B</sub>, P<sub>R</sub> OUT du lecteur DVD sur les prises Y, P<sub>B</sub>, P<sub>R</sub> IN du téléviseur à l'aide de câbles composante vidéo (non fournis).
- 2 Raccordez la prise AUDIO OUT du lecteur DVD sur la prise AUDIO IN du téléviseur.

Les sorties Y, P<sub>B</sub>, P<sub>R</sub> du lecteur DVD sont parfois désignées par Y, C<sub>B</sub> et C<sub>R</sub> ou Y, B-Y et R-Y. Dans ce cas, raccordez les câbles selon les couleurs.

### Utilisation de votre téléviseur avec ce raccordement

Ce raccordement vous permet de faire les actions suivantes :

- ❑ Programmer votre télécommande Sony de façon à contrôler votre lecteur DVD (voir page 6).
- ❑ Pour activer votre télécommande, appuyer sur pour contrôler votre lecteur DVD.
- ❑ Appuyer sur plusieurs fois sur pour passer à l'entrée du lecteur DVD (entrée VIDEO).

## Raccordement d'un caméscope

Pour raccorder votre caméscope, vous pouvez utiliser les entrées Audio/Video sur le panneau avant ou arrière du téléviseur. Raccordez les prises AUDIO et VIDEO OUT du caméscope sur les prises AUDIO et VIDEO IN du téléviseur à l'aide de câbles audio/vidéo (non fournis).

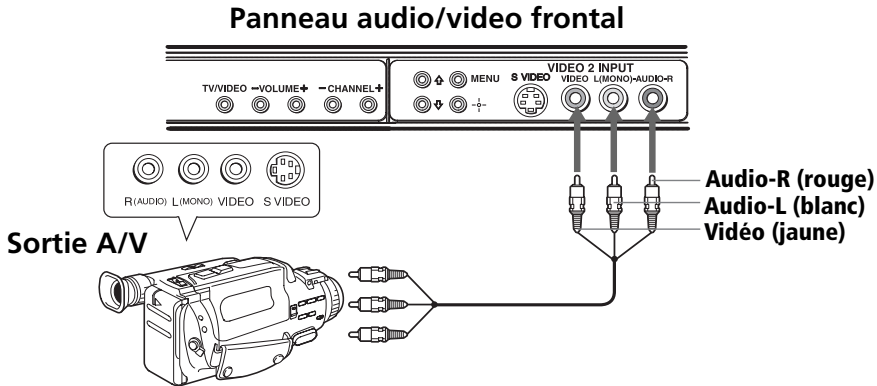

### Raccordement facultatif

- ❑ Pour obtenir une meilleure qualité d'image, utilisez S VIDEO plutôt que le câble vidéo jaune. S VIDEO ne procure pas de son, vous devez donc quand même brancher les câbles audio.

## Raccordement d'une chaîne audio

- 1 Avec des câbles audio-vidéo (non fournis), raccordez la prise AUDIO OUT du téléviseur à l'une des entrées de ligne non utilisées de votre chaîne stéréo (p. ex. TV, AUX ou TAPE2).
- 2 Placez l'option Haut-parleur en position OFF. Pour obtenir plus d'informations, consultez "Utilisation du menu Audio" à la page 33.
- 3 Ouvrez l'option Sortie audio du menu Audio et sélectionnez Fixe pour régler le volume par l'entremise du système audio qui est branché. Pour obtenir plus d'informations, consultez "Utilisation du menu Audio" à la page 33.

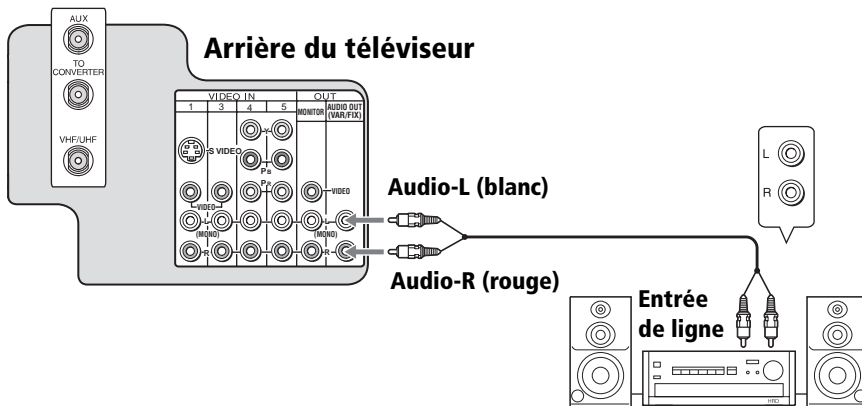

## Raccordement de deux magnétoscopes pour le montage de cassettes

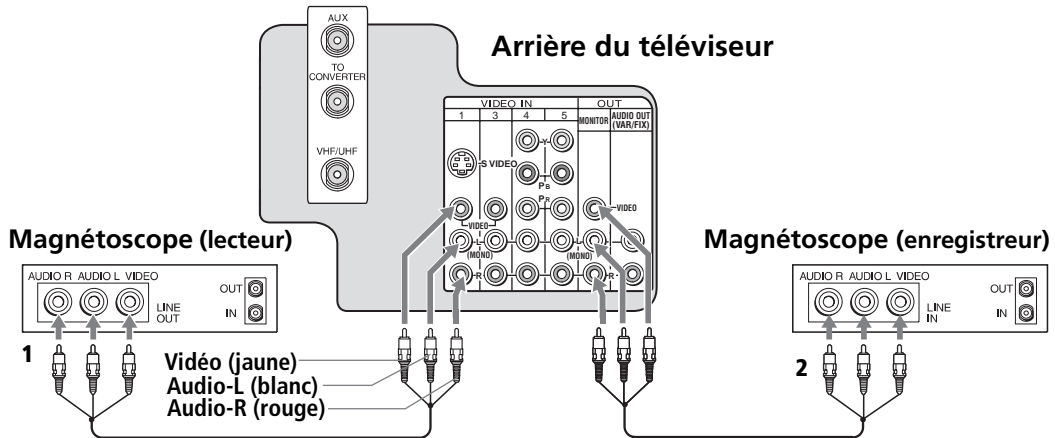

Vous pouvez raccorder deux magnétoscopes l'un à l'autre pour monter des bandes vidéo. Vous pouvez également raccorder les deux magnétoscopes au téléviseur pour visionner l'enregistrement en cours.



- 1** Avec des câbles audio-vidéo (non fournis), raccordez les prises AUDIO OUT et VIDEO OUT du premier magnétoscope aux prises AUDIO IN et VIDEO IN du téléviseur.
- 2** Avec des câbles audio/vidéo (non fournis), raccordez les prises AUDIO IN et VIDEO IN du second magnétoscope aux prises MONITOR AUDIO OUT et MONITOR VIDEO OUT du téléviseur.

### Utilisation de votre téléviseur avec ce raccordement

Ce raccordement vous permet de faire les actions suivantes :

- Programmer votre télécommande Sony de façon à contrôler votre magnétoscope (voir page 6).
- Pour activer votre télécommande, appuyer sur  pour contrôler votre magnétoscope. Consultez la page 8 pour connaître la façon d'utiliser les autres fonctions.
- Appuyer  plusieurs fois sur pour passer à l'entrée du lecteur DVD (entrées VIDEO).

# Utilisation des fonctions de base



## Réglage automatique du téléviseur

Après avoir procédé au raccordement de votre téléviseur, vous pouvez utiliser la fonction Auto programmation pour régler les chaînes. Avec la fonction Auto programmation, le téléviseur recherche automatiquement les canaux pouvant être captés et les programme dans la mémoire de l'appareil.

 Lorsque vous démarrez la fonction Auto programmation, attendez qu'elle se termine car des canaux disponibles risquent d'être sautés. Exécutez la fonction Auto programmation de nouveau pour programmer les canaux pouvant être captés.

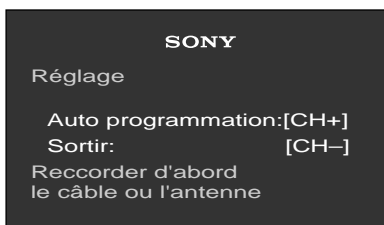









- 1 Appuyez sur  pour mettre le téléviseur sous tension. L'écran de réglage apparaît.





- 2 Appuyez sur la touche  de la télécommande ou sur le panneau avant du téléviseur pour exécuter Auto programmation ou appuyez sur  pour quitter.

 Chaque fois que vous allumez le téléviseur, l'écran Réglage initial apparaît, et ce jusqu'à ce que vous ayez effectué Auto programmation.

### Pour exécuter de nouveau la fonction Auto programmation



- 1 Appuyez sur .
- 2 Appuyez sur  pour mettre le menu Canal en surbrillance.
- 3 Appuyez sur  pour mettre Câble en surbrillance. Appuyez sur  pour valider la sélection.
- 4 Appuyez sur  ou  pour sélectionner Oui ou Non selon les raccordements de votre téléviseur. Appuyez sur .
- 5 Appuyez sur  pour mettre Auto programmation en surbrillance. Appuyez sur  pour rechercher les canaux.
- 6 Lorsque la fonction Auto programmation a été exécutée, appuyez sur  pour quitter.

### Pour réinitialiser le téléviseur aux réglages par défaut

- 1 Allumez le téléviseur.
- 2 Maintenez enfoncée la touche  de la télécommande.
- 3 Appuyez sur la touche POWER sur le panneau avant du téléviseur et relâchez-la. (Le téléviseur s'éteint, puis se rallume de lui-même).
- 4 Relâchez la touche .

## Accès rapide aux menus

Les réglages suivants sont disponibles dans les menus d'écran. Pour plus de détails sur le mode d'emploi des menus, voir "Utilisation des menus" à la page 31.

Menu	Permet de
	Procéder aux réglages de l'image.
	Modifier les réglages du son.
	Personnaliser les réglages des canaux.
	Définir des limites de classement sur votre téléviseur en fonction du contenu ou du classement de l'émission.

Menu

Permet de



Régler l'horloge du téléviseur et programmer les émissions souhaitées avec Minuterie 1 et Minuterie 2.



Sélectionner une option de sous-titrage, saisir une étiquette vidéo, corriger la rotation de l'image provenant d'un DVD (16:9 amélioré), sélectionner la langue des menus ou lancer une démonstration des menus.



Choisir l'affichage d'un menu simplifié contenant les réglages les plus courants.

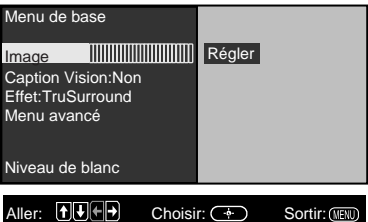



## Utilisation de la fonction image sur image (PIP)

La fonction image sur image (PIP) permet de regarder deux canaux simultanément. Le premier canal s'affiche en tant qu'image principale remplissant l'écran, et le second canal apparaît dans une petite fenêtre, ou image secondaire.

### Affichage image sur image

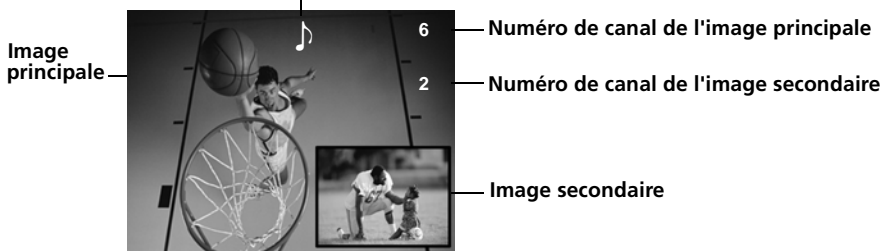

Indique à quelle image correspond le son entendu



#### Pour utiliser la fonction PIP







- 1 Appuyez sur la touche TV pour commander la fonction PIP avec les touches jaunes. Réglez le téléviseur sur un canal en cours de diffusion.
- 2 Appuyez sur la touche  pour afficher l'image secondaire.
- 3 Utilisez les touches CH+/- de la fonction PIP (jaunes) pour changer le canal de l'image secondaire.

#### Pour vérifier la fonction PIP

- 1 Appuyez sur la touche TV pour commander la fonction PIP avec les touches jaunes. Réglez le téléviseur sur un canal en cours de diffusion.
- 2 Appuyez sur  pour activer la fonction PIP. Appuyez sur . L'émission de l'image principale devrait maintenant être affichée dans la fenêtre secondaire.
- 3 Sélectionnez le même canal pour l'image principale (utilisez les touches CH+/- au bas de la télécommande).
- 4 Utilisez les touches CH+/- de la fonction PIP (jaunes) pour changer le canal de l'image secondaire.
- 5 Utilisez la touche PIP jaune  pour changer la source de l'image secondaire afin qu'elle provienne de l'un des autres appareils vidéo raccordés au téléviseur par les prises VIDEO IN. L'image affichée dans la fenêtre secondaire devrait être différente pour chaque appareil vidéo raccordé. Assurez-vous que les appareils raccordés sont sous tension et en marche lorsque vous effectuez cette vérification.

 Si des problèmes surviennent lors de l'utilisation de la fonction PIP, reportez-vous à la section "Raccordements qui affectent l'utilisation de la fonction image sur image (PIP)" (page 30) ou à la section "Informations complémentaires" (page 47) pour obtenir des solutions.

## Touches de fonction PIP

Touche PIP jaune	Description
	Appuyez une fois sur cette touche pour activer ou désactiver la fonction PIP. Appuyez plusieurs fois pour changer la taille de l'image secondaire (1/9, 1/16, Non).
	Permet de passer d'une source vidéo disponible à une autre parmi les appareils vidéo raccordés au téléviseur (dans la fenêtre secondaire). Les appareils raccordés à VIDEO 4-5 (Y, Pb, Pr) ne sont pas disponibles en mode PIP.
	Permet d'alterner entre le son de l'image principale et celui de l'image secondaire. Le symbole 🎵 apparaît pendant trois secondes pour indiquer la provenance du son (source de l'image principale ou de l'image secondaire).
	Permet de changer le canal affiché dans la fenêtre de l'image secondaire. Pour changer le canal de l'image principale, utilisez les touches principales CH+/- au bas de la télécommande.
	Permet de déplacer la fenêtre de l'image secondaire vers un des quatre coins de l'écran.
	Permet de faire un arrêt sur image dans l'image secondaire. Appuyer de nouveau pour rétablir le mouvement de l'image. L'image principale n'est pas affectée.
	Permet d'invertir l'image principale et celle de l'image secondaire. Il suffit d'appuyer une autre fois pour inverser les images de nouveau.

 Pour plus de détails sur le fonctionnement de la télécommande, reportez-vous à la section "Utilisation de la télécommande" à la page 3.

### Pour changer les émissions ou les canaux de l'image secondaire

- Utilisez la touche jaune PIP CH+/- pour faire défiler les canaux de télévision.
- Utilisez la touche jaune TV/VIDEO pour passer d'une source vidéo disponible à une autre parmi les appareils vidéo raccordés au téléviseur, tels que le magnétoscope, le lecteur de DVD ou le récepteur satellite.

## Raccordements qui affectent l'utilisation de la fonction image sur image (PIP)







- ❑ Il n'est pas possible de visionner les images des appareils vidéo raccordés à l'entrée AUX dans la fenêtre secondaire PIP.
- ❑ Si tous les canaux sont captés par l'entremise d'un décodeur de câblodistribution, la fonction PIP ne fonctionne pas. Comme le décodeur de câblodistribution ne décode qu'un seul signal à la fois, l'image principale et l'image secondaire affichent toujours le même canal. Pour obtenir plus de détails sur la façon de raccorder votre décodeur et d'utiliser la fonction d'image sur image, consultez la page 17.
- ❑ Les appareils raccordés dans les prises VIDEO 4-5 (Y, Pb, Pr) ne s'affichent pas avec la fonction PIP.



# Utilisation des menus

Cette section présente les options disponibles pour le réglage du téléviseur.

## Comment accéder aux menus

### Pour accéder aux menus

- 1** Appuyez sur  pour afficher le menu d'écran.
- 2** Utilisez les touches  ou  pour sélectionner l'élément souhaité dans le menu. Appuyez ensuite sur  pour le valider.
- 3** Utilisez les touches  ou  pour faire défiler les fonctions vers le haut ou vers le bas.
- 4** Suivez les directives à l'écran.
- 5** Consultez la page de menu spécifique pour obtenir des directives de navigation dans ce menu.
- 6** Appuyez sur  pour quitter le menu.

 Appuyez sur  une fois pour afficher le menu à l'écran. Appuyez de nouveau pour revenir à l'écoute normale. Si aucune touche n'est enfoncée, le menu se ferme automatiquement après environ 90 secondes.

## Utilisation du menu Vidéo



Pour ouvrir le menu Vidéo, suivez les étapes ci-dessous:

**Pour afficher**



**Pour sélectionner**



Appuyez sur pour sélectionner une option, puis appuyez sur .



### Mode

Visualisation personnalisée d'images

Utilisez les touches ou pour sélectionner l'une des options suivantes. Appuyez ensuite sur pour valider votre sélection.

**Éclatant :** Sélectionnez cette fonction pour obtenir un contraste et une netteté de l'image plus marqués.

**Standard :** Sélectionnez cette fonction pour obtenir une image standard.

**Film :** Sélectionnez cette fonction pour obtenir une image précise.

**Sports :** Sélectionnez cette fonction pour obtenir une image lumineuse.

**Pro :** Sélectionnez cette fonction pour obtenir une image naturelle plus de netteté.



Pour accéder directement aux modes image personnalisés (Éclatant, Standard, Film, Pro), appuyez sur la touche de la télécommande.

### Image

Appuyez sur pour diminuer le contraste. Appuyez sur pour augmenter le contraste.

### Luminosité

Appuyez sur pour assombrir l'image. Appuyez sur pour éclaircir l'image.

### Couleur

Appuyez sur pour diminuer la saturation des couleurs. Appuyez sur pour augmenter la saturation des couleurs.

### Nuance

Appuyez sur pour augmenter les tons rouges. Appuyez sur pour augmenter les tons verts.

### Netteté

Appuyez sur pour adoucir l'image. Appuyez sur pour rendre l'image plus nette.

### Temp. couleur

Réglage de la teinte des blancs

Utilisez la touche multidirectionnelle pour faire défiler le menu vers le haut ou vers le bas et sélectionnez l'une des options suivantes. Appuyez ensuite sur pour valider la sélection.

**Froide :** Donne une teinte bleue aux couleurs blanches.

**Neutre :** Donne une teinte neutre aux couleurs blanches.

**Chaude :** Donne une teinte rouge aux couleurs blanches.

### ClearEdge VM

Accentue la définition de l'image pour donner une bordure nette aux objets. Utilisez la touche multidirectionnelle pour faire défiler le menu vers le haut ou vers le bas et sélectionnez l'une des options suivantes : **Non**, **Haut**, **Bas**. Appuyez ensuite sur .

### DynaBlack

Accentue le contraste et les détails de l'image. Utilisez la touche multidirectionnelle pour faire défiler le menu vers le haut ou vers le bas et sélectionnez l'une des options suivantes : **Non**, **Haut**, **Bas**. Appuyez ensuite sur .

## Utilisation du menu Audio



Pour ouvrir le menu Audio, suivez les étapes ci-dessous :

**Pour afficher**



**Pour mettre surbrillance**



**Pour sélectionner**





Appuyez sur pour sélectionner une option, puis appuyez sur .





<b>Aigu</b>	Appuyez sur  pour diminuer les sons les plus élevés. Appuyez sur  pour augmenter les sons les plus élevés.
<b>Grave</b>	Appuyez sur  pour diminuer les sons les plus graves. Appuyez sur  pour augmenter les sons les plus graves.
<b>Balance</b>	Appuyez sur  pour accentuer le son du haut-parleur gauche. Appuyez sur  pour accentuer le son du haut-parleur droit.
<b>Volume auto</b>	Utilisez les touches  ou  pour sélectionner l'une des options suivantes. Appuyez ensuite sur  pour la valider. <b>Oui:</b> Sélectionnez cette option pour stabiliser le volume pendant les changements de canaux. <b>Non:</b> Sélectionnez cette option pour désactiver la fonction Volume auto.
<b>Effet</b>	Utilisez les touches  ou  pour sélectionner l'une des options suivantes. Appuyez ensuite sur  pour la valider. <b>Simulé:</b> Simule un environnement sonore de salle de cinéma pour des émissions en mono. <b>WOW:</b> Produit un son spectaculaire avec des graves puissantes et profondes. Lorsque la fonction WOW est activée, BBE est également activée automatiquement pour améliorer encore davantage la qualité sonore. <b>TruSurround:</b> Produit un son tridimensionnel dynamique pour les signaux sonores stéréo. <b>Non :</b> Réception stéréo ou mono normale.

Appuyez sur pour sélectionner directement l'option de réglage Effet (Simulé, WOW, TruSurround, Non).



---

<b>MTS</b> <i>Son multi-canal</i>	Utilisez les touches  ou  pour sélectionner l'une des options suivantes. Appuyez ensuite sur  pour valider la sélection.
<b>Stéréo :</b>	Sélectionnez cette option lorsque vous regardez une émission en stéréo.
<b>Auto SAP :</b>	Sélectionnez cette option pour que le téléviseur passe automatiquement à un programme audio secondaire (SAP) à la réception d'un signal.
<b>Mono :</b>	Sélectionnez cette option pour réduire les parasites dans les zones où la réception est médiocre.



 Pour accéder directement aux réglages MTS (Stéréo, Auto SAP, Mono), appuyez sur la touche  de la télécommande.

 Si votre téléviseur est réglé sur Auto SAP, il est possible que le son de certains programmes soit mis en sourdine ou déformé. Si votre téléviseur n'émet aucun son, réglez Audio MTS sur Stéréo ou Mono.

---

<b>Haut-parleur</b> <i>Sélection personnalisée de la source de sortie audio</i>	Utilisez les touches  ou  pour sélectionner l'une des options suivantes. Appuyez ensuite sur  pour valider la sélection.
<b>Oui :</b>	Sélectionnez cette option pour écouter le son à partir des haut-parleurs du téléviseur avec ou sans une chaîne stéréo indépendante.
<b>Non :</b>	Sélectionnez cette option pour désactiver les haut-parleurs du téléviseur et écouter le son du téléviseur uniquement via les enceintes d'une chaîne audio externe.

---

<b>Sortie audio</b> <i>Utilisez cette fonction pour commander le volume du téléviseur par l'entremise d'une chaîne stéréo.</i>	Utilisez les touches  ou  pour sélectionner l'une des options suivantes. Appuyez ensuite sur  pour valider la sélection.
<b>Variable :</b>	Règle le volume par l'intermédiaire du téléviseur.
<b>Fixe :</b>	Règle le volume du téléviseur par l'intermédiaire d'une chaîne stéréo raccordée.

 Il est seulement possible de régler les paramètres de sortie audio lorsque Haut-parleur est réglé sur Non.

## Utilisation du menu Canal



Pour accéder au menu Canal, procédez comme suit :



Appuyez sur  $\downarrow$  de la touche multidirectionnelle pour sélectionner une option, puis appuyez sur  $\oplus$ .



### Canaux préférés

Accès rapide aux canaux préférés

- 1 Appuyez sur  $\oplus$  pour effectuer votre sélection.
- 2 Sélectionnez la position (1 à 8) où vous souhaitez régler une chaîne préférée à l'aide des touches  $\uparrow$  ou  $\downarrow$ , puis appuyez sur  $\oplus$ .
- 3 Utilisez les touches  $\uparrow$  ou  $\downarrow$  pour sélectionner le canal que vous souhaitez ajouter à vos canaux préférés.
- 4 Appuyez sur  $\oplus$  pour sélectionner le canal. Le téléviseur se met automatiquement au canal sélectionné.
- 5 Appuyez sur  $\leftarrow$  pour revenir au menu Canal ou appuyez sur  $\text{MENU}$  pour quitter.

Pour utiliser la fonction Canaux préférés : quittez tous les menus et appuyez sur  $\oplus$ . Appuyez sur  $\uparrow$  ou  $\downarrow$  pour déplacer le curseur vers le numéro de canal souhaité et appuyez sur  $\oplus$ .

### Câble

Utilisez les touches  $\uparrow$  ou  $\downarrow$  pour sélectionner l'une des options suivantes. Appuyez ensuite sur  $\oplus$  pour valider la sélection.

- Oui :** Sélectionnez cette option si vous recevez des chaînes câblées avec un câble CATV.
- Non :** Sélectionnez cette option si vous utilisez une antenne de télévision.

Vous devez exécuter la fonction Auto programmation après avoir modifié vos réglages de câble. Consultez "Pour exécuter de nouveau la fonction Auto programmation" à la page 25.



<b>Canal fixe</b>	Utilisez les touches $\uparrow$ ou $\downarrow$ pour sélectionner l'une des options suivantes. Appuyez ensuite sur $\rightarrow$ pour valider la sélection. <b>Non :</b> Canal fixe n'est pas réglé. <b>2-6 :</b> Sélectionnez cette option pour contrôler toutes les sélections de canaux par l'entremise d'un décodeur ou d'un magnétoscope. Sélectionnez le canal approprié (en général 3 ou 4) et utilisez la télécommande du décodeur ou du magnétoscope pour sélectionner les canaux. <b>AUX 2-6:</b> Sélectionnez cette option plutôt que <b>2-6</b> si vous voulez changer de canaux à l'aide d'un décodeur, d'un magnétoscope ou d'un récepteur satellite et que vous l'avez raccordé à la prise AUX. <b>Vidéo 1 :</b> Sélectionnez l'une des entrées vidéo disponibles lorsque vous avez raccordé l'appareil vidéo (par exemple un récepteur satellite) et que vous souhaitez régler le téléviseur en fonction de cet appareil.
-------------------	---

 Lorsque Canal fixe est activé, vous ne pouvez pas utiliser Canaux préférés, Câble, Saut/ajout canal ou Légende de canal.

<b>Auto programmation</b>	Utilisez la fonction Auto programmation chaque fois que vous réglez votre téléviseur. Avec la fonction Auto programmation, le téléviseur recherche automatiquement les canaux pouvant être captés et les programme dans la mémoire de l'appareil.
---------------------------	--

<b>Saut/Ajout canal</b>	Utilisez cette fonction après avoir exécuté Auto programmation pour omettre des chaînes que vous ne souhaitez pas ou en ajouter des nouvelles. <b>1</b> Sélectionnez la position de la chaîne souhaitée à l'aide des touches $\uparrow$ ou $\downarrow$ , puis appuyez sur $\rightarrow$ . <b>2</b> Sélectionnez <b>Saut</b> ou <b>Ajout</b> à l'aide des touches $\uparrow$ ou $\downarrow$ , puis appuyez sur $\rightarrow$ . <b>3</b> Appuyez sur $\leftarrow$ pour revenir au menu Canal ou appuyez sur $\text{MENU}$ pour quitter.
-------------------------	--

 Lorsque vous appuyez sur CH (canal) + ou CH (canal) -, les canaux sautés sont ignorés et le canal suivant est sélectionné. Vous pouvez quand même accéder aux canaux ignorés en vous servant des touches  $\text{①}$ - $\text{⑨}$ .

<b>Légende de canal</b> <i>Permet de nommer 40 chaînes au maximum avec des indicatifs littéraux.</i>	<b>1</b> Appuyez sur $\rightarrow$ , puis sur $\uparrow$ ou $\downarrow$ jusqu'à ce que le numéro du canal souhaité soit atteint. <b>2</b> Appuyez sur $\rightarrow$ pour activer le canal. <b>3</b> Appuyez sur $\rightarrow$ pour sélectionner <b>Légende</b> , puis sur $\downarrow$ . Utilisez les touches $\uparrow$ ou $\downarrow$ pour afficher le premier nombre ou la première lettre de l'indicatif du titre, puis appuyez sur $\rightarrow$ pour le sélectionner. Répétez ce processus pour toutes les caractères à saisir. $\rightarrow$ <b>4</b> Lorsque vous avez terminé, appuyez sur $\rightarrow$ pour l'activer. <b>5</b> Appuyez sur $\leftarrow$ pour revenir au menu Canal ou sur $\text{MENU}$ pour quitter.
---	---

## Utilisation du menu Parent



Pour ouvrir le menu Parent, suivez les étapes ci-dessous :

**Pour afficher**



**Pour mettre en surbrillance**



**Pour sélectionner**



La fonction de Contrôle parental est conçue pour aider les parents à surveiller ce que leurs enfants regardent à la télévision.

### Utilisation du menu Parent

Dans le menu Parent, un message vous invite à choisir un mot de passe à quatre chiffres qui est ensuite nécessaire pour accéder au menu Parent.

- 1** À l'aide des touches 0-9, saisissez un mot de passe à quatre chiffres.
- 2** Confirmez votre mot de passe en le saisissant de nouveau.

 Conservez ce mode d'emploi en lieu sûr. Une fois enregistré, le mot de passe est nécessaire pour accéder au menu de contrôle parental. En cas d'oubli du mot de passe, voir page 47.

# Contrôle parental

## Réglage du classement

Vous pouvez modifier le classement en sélectionnant l'une des options de blocage.



**1** Appuyez sur  $\downarrow$  pour mettre **Blocage parental** en surbrillance, puis appuyez sur  $\rightarrow$ .

Si le système de classification à l'intention des parents ne vous est pas familier, utilisez une des catégories prédéfinies suivantes pour simplifier la sélection : Enfant, Jeune, Adolescent

**2** Sélectionnez le classement souhaité à l'aide des touches  $\uparrow$  ou  $\downarrow$ , puis appuyez sur  $\rightarrow$ .

Classement	Le téléviseur bloque les émissions dont la classification dépasse :
<b>Non</b>	Aucune limite de classement
<b>Enfant</b>	TV-Y, TV-G, G (modèles américains seulement), G, C (modèles canadiens seulement)
<b>Jeune</b>	TV-PG, PG (modèles américains seulement), 8 ans + (modèles canadiens seulement)
<b>Adolescent</b>	TV-14, PG-13 (modèles américains seulement), 14+ (modèles canadiens seulement)
<b>Spécifique</b>	Sélectionnez cette option pour définir des classements plus restrictifs (voir la section suivante)

## Modification du mot de passe

**1** Déplacez le curseur à l'aide des touches  $\uparrow$  ou  $\downarrow$  pour activer **Changer le Mot de passe**, puis appuyez sur  $\rightarrow$ .

**2** Suivez les étapes 1 et 2 de la section " Utilisation du menu Parent ", page 37.

## Sélection d'un pays



Sélectionnez U.S.A. pour la classification américaine (voir les pages 40-41) ou Canada pour la classification canadienne (voir page 42). Si vous sélectionnez un pays (États-Unis ou Canada) qui n'est pas celui où vous utilisez le téléviseur, le blocage sélectionné n'est pas activé.

**1** Appuyez sur  $\downarrow$  pour sélectionner **Pays**, puis appuyez sur  $\rightarrow$ .

**2** Utilisez les touches  $\uparrow$  ou  $\downarrow$  pour sélectionner le pays (États-unis ou Canada), puis appuyez sur  $\rightarrow$ .

## Renseignements à l'intention des parents

### Pour regarder une émission qui sort du classement

- Appuyez sur , puis utilisez les touches - pour saisir votre mot de passe.

 Si vous entrez votre mot de passe pour regarder un programme bloqué, l'option Blocage sera temporairement réglée sur Non. Pour réactiver les réglages Blocage, éteignez votre téléviseur et remettez le sous tension. Le téléviseur revient aux réglages que vous avez sélectionnés.

### Utilisation du menu Spécifique

Suivez les instructions affichées à l'écran pour effectuer vos réglages personnalisés. Sélectionnez le pays souhaité pour vos limites de classement des émissions de télévision. Afin d'obtenir plus d'informations, consultez la page 40 pour les modèles américains et la page 42 pour les modèles canadiens..

 Lorsque vous avez bloqué un classement ou un contenu, tous les classements ou contenus supérieurs seront automatiquement bloqués.

## États-unis : sélection des options de classement spécifique

Pour les modèles destinés aux États-unis, le menu Classement spécifique comprend les options suivantes : Classement des films, Classement de télé et Non-classée (Pour les modèles destinés au Canada, voir page 42).

### Classement des films

Ce système définit les niveaux de classement des films projetés dans les cinémas et sur les principales chaînes du câble.

Classement	Description
<b>G</b>	Tout public
<b>PG</b>	Surveillance parentale recommandée
<b>PG-13</b>	Les parents sont sérieusement mis en garde
<b>R</b>	Accès limité
<b>NC-17</b>	Interdit aux spectateurs de 17 ans ou moins
<b>X</b>	Réservé aux adultes

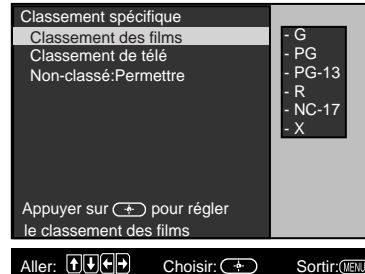

### Classement de télé

Le classement de télé est divisé en deux groupes : en fonction de l'âge et en fonction du contenu.

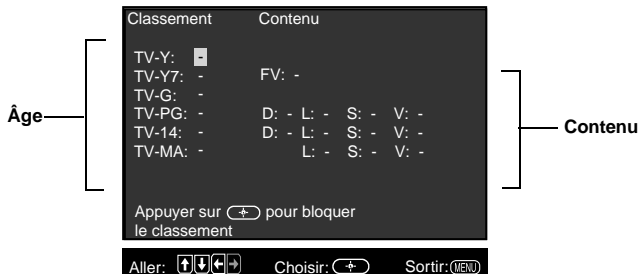

Âge	Description
<b>TV-Y</b>	Tous les enfants
<b>TV-Y7</b>	Pour les enfants plus âgés
<b>TV-G</b>	Tout public
<b>TV-PG</b>	Surveillance parentale recommandée
<b>TV-14</b>	Avertissement adressés aux parents
<b>TV-MA</b>	Réservé aux adultes exclusivement

Contenu	Description
<b>FV</b>	Violence suggérée
<b>D</b>	Dialogues suggestifs
<b>L</b>	Langage grossier
<b>S</b>	Scènes sexuelles
<b>V</b>	Violence

 Les classements du contenu augmentent selon le niveau du classement basé sur l'âge. Par exemple, une émission classée TV-PG V (violence) peut contenir des scènes de violence modérée tandis qu'un classement TV-14 V (violence) peut contenir des scènes très violentes.

## Non classée

Vous pouvez bloquer des émissions de télévision ou des films qui ne sont pas classés.

<b>Permettre</b>	Autorise toutes les émissions non classées
<b>Bloquer</b>	Bloque toutes les émissions non classées

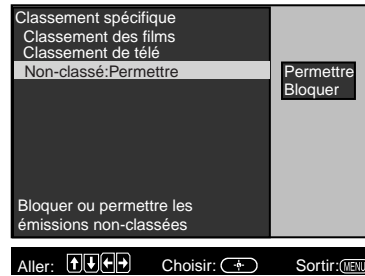

 Si vous choisissez de bloquer les émissions de télévision non classées, notez que les émissions suivantes seront également bloquées : bulletins d'informations d'urgence, émissions politiques, sports, actualités, annonce des services publics, émissions religieuses et météo.

## Canada : sélection des options de classement spécifique

Pour les modèles destinés au Canada, le menu Classement spécifique comprend les options suivantes : Classement anglais, Classement français et Classement U.S.A.

### Classement anglais

Ces classements concernent les émissions canadiennes diffusées en anglais.

Classement	Description
<b>C</b>	Enfants
<b>C8+</b>	Enfants de 8 ans et plus
<b>G</b>	Tout public
<b>PG</b>	Supervision parentale
<b>14+</b>	Spectateurs de 14 ans et plus
<b>18+</b>	Emission réservée aux adultes



### Classement français

Ces classements concernent les émissions canadiennes diffusées en français.

Classement	Description
<b>G</b>	Tout public
<b>8 ans+</b>	Déconseillé aux jeunes enfants
<b>13 ans+</b>	Déconseillé aux enfants de moins de 13 ans
<b>16 ans+</b>	Déconseillé aux enfants de moins de 16 ans
<b>18 ans+</b>	Cette émission est destinée aux adultes exclusivement



### Classement U.S.A.

Pour les émissions provenant des États-unis, veuillez vous reporter à " Classement de télé " page 40.

## Utilisation du menu Heure



Pour ouvrir le menu Heure, suivez les étapes ci-dessous :

**Pour afficher**



**Pour mettre en surbrillance**



**Pour sélectionner**

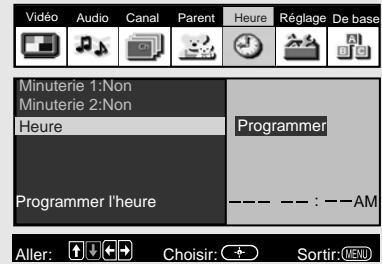

### Heure

Réglez votre téléviseur au jour et à l'heure actuels. Appuyez sur pour ouvrir le menu Heure :

- 1 Utilisez les touches ou pour saisir le jour et l'heure corrects, puis appuyez sur .
- 2 Appuyez sur pour revenir au menu Heure ou sur pour quitter le menu.

Vous devez régler l'heure actuelle avant d'utiliser les fonctions Minuterie 1 et Minuterie 2.

### Minuterie 1 et Minuterie 2 Visualisation programmée

Les minuteries permettent de programmer la mise sous tension et hors tension du téléviseur selon le jour, l'heure et la durée, ainsi que le canal à syntoniser. La durée maximale du programme de minuterie est de six heures. Lorsque la fonction Canal fixe est active, il n'est pas nécessaire de programmer le canal.

- 1 Sélectionnez **Minuterie 1** ou **Minuterie 2** à l'aide des touches ou , puis appuyez sur .
- 2 Appuyez sur ou pour saisir le jour, l'heure, la durée et le canal, puis appuyez sur . Une fois son réglage terminé, la minuterie doit être réglée sur Oui, et le témoin de minuterie devrait s'allumer sur le panneau avant du téléviseur.
- 3 Appuyez sur pour quitter le menu.

Sélectionnez Non pour désactiver la minuterie (les réglages précédents sont sauvegardés).

Lorsque vous exécutez Auto programmation, les réglages Minuterie 1 et Minuterie 2 sont effacés. De même, en cas de coupure d'alimentation, les réglages Heure, Minuterie 1 et Minuterie 2 sont effacés.



# Utilisation du menu Réglage



Pour accéder au menu Réglage, procédez comme suit :

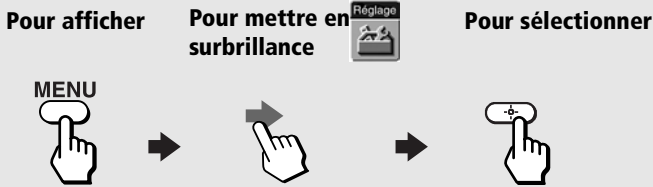

Appuyez sur pour sélectionner une option, puis appuyez sur .

## Caption Vision

*Sous-titrage*

Permet de sélectionner l'un des trois modes de sous-titrage (pour les émissions diffusées avec l'option sous-titres).

Utilisez les touches ou pour sélectionner l'une des options suivantes. Appuyez ensuite sur pour valider la sélection.

- Non :** Les sous-titres ne sont pas activés.
- CC1, 2, 3, 4 :** Affiche le dialogue imprimé et les effets sonores d'une émission.
- Text1, 2, 3, 4 :** Affiche des informations du réseau/de la station.
- Info :** Lorsque vous changez de canal ou que vous appuyez sur AFFICHAGE, affiche le nom du programme en cours et son temps restant, si ces informations sont disponibles.

## Étiquette vidéo

*Donne un nom aux appareils raccordés*

Permet d'attribuer des noms aux appareils vidéo raccordés au téléviseur : magnéto, lecteur de DVD, etc. Lorsque vous commutez la source du signal en appuyant sur TV/VIDEO, l'étiquette vidéo s'affiche à l'écran.

- 1 Appuyez sur les touches ou pour accéder à l'entrée que vous souhaitez nommer, puis appuyez sur .
- 2 Choisissez un nom à l'aide des touches ou , puis appuyez sur .
- 3 Appuyez sur pour revenir au menu Réglage ou sur pour quitter.

Si vous sélectionnez **Saut**, le téléviseur saute cette prise lorsque vous appuyez sur la touche TV/VIDEO.

## Rotation

Appuyez sur ou pour corriger une inclinaison de l'image de - 5 à + 5, puis appuyez sur pour activer le réglage.

## Langue

Affiche tous les menus dans la langue de votre choix. Utilisez la touche ou pour sélectionner l'une des options suivantes: **English** (anglais), **Español** (espagnol), **Français**. Appuyez ensuite sur la touche .

## 16:9 amélioré

Améliore la résolution des images provenant de sources au format grand écran, par exemple les films sur DVD (disponible uniquement lorsque le téléviseur est en mode VIDEO).

## Démo

Appuyez sur pour lancer une démonstration des menus à l'écran.

Appuyez sur n'importe quelle touche pour quitter le mode Démo.

## Utilisation du Menu de base



Pour accéder au Menu de base, procédez comme suit :

**Pour afficher**



**Pour mettre en surbrillance**



**Pour sélectionner**



Appuyez sur pour sélectionner une option, puis appuyez sur .

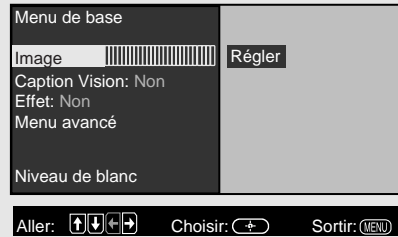

### Image

Contraste de l'image

Appuyez sur pour diminuer le contraste. Appuyez sur pour augmenter le contraste.

### Caption Vision

Sous-titres

Le Menu de base affiche l'option de sous-titrage actuellement activée. La valeur par défaut est Non. (CC1-4, Text1-4 ou Info).

### Effet

Utilisez les touches ou pour sélectionner l'une des options suivantes. Appuyez ensuite sur pour valider la sélection.

**Simulé:** Simule un environnement sonore de salle de cinéma pour des émissions en mono.

**WOW:** Produit un son spectaculaire avec des graves puissantes et profondes. Lorsque la fonction WOW est activée, BBE est également activée automatiquement pour améliorer encore davantage la qualité sonore.

**TruSurround:** Produit un son tridimensionnel dynamique pour les signaux sonores stéréo.

**Non:** Réception stéréo ou mono normal.

### Menu avancé

Appuyez sur pour revenir au menu avancé.



Si vous quittez le Menu de base en appuyant sur , seul le Menu de base s'affiche lorsque vous appuyez de nouveau sur . Pour accéder aux autres menus, utilisez pour faire défiler le menu vers le bas et sélectionnez Menu avancé, puis appuyez sur .

# Information complémentaires

## Guide de dépannage

Si vous rencontrez un problème avec votre téléviseur, essayez d'appliquer les suggestions ci-dessous. Si le problème persiste, contactez votre distributeur Sony.

### Généralités

Problème	Solutions possibles
<b>Pour réinitialiser le téléviseur aux réglages par défaut</b>	<input type="checkbox"/> Allumez le téléviseur. Tout en maintenant enfoncée la touche RESET de la télécommande, appuyez sur la touche POWER sur le panneau avant du téléviseur. (Le téléviseur s'éteint, puis se rallume de lui-même). Relâchez ensuite la touche RESET.
<b>Impossible d'accéder aux autres menus à partir du Menu de base</b>	<input type="checkbox"/> Si vous quittez le Menu de base en appuyant sur  , seul le Menu de base s'affiche lorsque vous appuyez de nouveau sur  . Pour accéder aux autres menus, sélectionnez l'option Menu avancé (page 45).
<b>Le téléviseur doit être nettoyé.</b>	<input type="checkbox"/> Nettoyez le téléviseur avec un chiffon sec et doux. N'utilisez jamais de solvants puissants, comme un diluant ou de la benzine, pouvant endommager le revêtement du châssis.
<b>Oubli du mot de passe du contrôle parental</b>	<input type="checkbox"/> Saisissez le mot de passe principal dans l'écran du mot de passe, à savoir 4357. Vous devez créer un nouveau mot de passe après avoir utilisé le mot de passe principal. Il ne peut pas être utilisé pour débloquer des canaux bloqués.
<b>Une fenêtre noire apparaît à l'écran</b>	<input type="checkbox"/> Une option de texte a été sélectionnée dans le menu de Réglage et aucun texte n'est disponible (page 44). Pour désactiver cette fonction, sélectionnez Non dans l'option Sous-titres (Caption Vision). Pour désactiver cette fonction, sélectionnez Non dans l'option Sous-titres (Caption Vision). Pour obtenir les sous-titres, sélectionnez CC1-4 au lieu de Text 1-4.
<b>Le téléviseur ne se met pas sous tension après et l'indicateur (LED) de la minuterie clignote à la suite d'une panne d'électricité ou d'une interruption.</b>	<input type="checkbox"/> Appuyez encore une fois sur la touche POWER de la télécommande ou sur le panneau avant du téléviseur.

Problème	Solutions possibles
<b>Le décodeur numérique ne fonctionne pas</b>	<ul style="list-style-type: none"><li>❑ Assurez-vous que le décodeur numérique n'est pas connecté dans la prise TO CONVERTER du téléviseur. Cette prise n'est pas compatible avec les décodeurs numériques.</li><li>❑ Si vous raccordez un magnétoscope et un décodeur numérique à l'aide d'un répartiteur, tel que décrit aux pages 17 et 18, vous devez utiliser un répartiteur bidirectionnel spécial compatible avec votre décodeur numérique.</li></ul>

## Télécommande

Problème	Solutions possibles
<b>La télécommande ne fonctionne pas</b>	<ul style="list-style-type: none"><li>❑ Appuyez sur TV (FUNCTION) pour faire fonctionner le téléviseur.</li><li>❑ Vérifiez le sens d'insertion des piles.</li><li>❑ Les piles sont peut-être faibles. Remplacez les piles (page 2).</li><li>❑ Placez le téléviseur à une distance d'au moins 90 à 120 cm (3 à 4 pi) des lampes fluorescentes.</li></ul>
<b>Impossible de changer de canal à l'aide de la télécommande</b>	<ul style="list-style-type: none"><li>❑ Si vous changez de canal avec un autre appareil, vérifiez que le réglage du téléviseur au canal 3 ou 4 n'a pas été changé accidentellement.</li><li>❑ Si vous changez de canal avec un autre appareil, veillez à appuyer d'abord sur la touche FUNCTION correspondant à cet appareil. Par exemple, pour changer de canal à partir du magnétoscope, veillez à appuyer sur la touche VCR/DVD FUNCTION (page 4).</li></ul>
<b>Vous avez perdu votre télécommande</b>	<ul style="list-style-type: none"><li>❑ Les commandes du panneau avant permettent d'accéder aux menus, de changer de canal, de régler le volume et de commuter les entrées vidéo (page 2). Contactez le détaillant Sony le plus près de chez vous pour commander une télécommande de rechange. Les résidents des États-Unis peuvent également contacter le "Sony Direct Accessory and Part Center" au 1-800-488-7669.</li></ul>

## Programmation de la télécommande



Problème	Solutions possibles
<b>Plus d'un code est indiqué</b>	<ul style="list-style-type: none"><li>❑ Essayez de les entrer un à un jusqu'à ce que vous ayez trouvé le bon code pour votre composante.</li></ul>
<b>J'ai entré le mauvais numéro de code</b>	<ul style="list-style-type: none"><li>❑ Si vous entrez un nouveau numéro de code, celui que vous avez entré précédemment est effacé.</li></ul>

Problème	Solutions possibles
<b>Je n'arrive pas à contrôler une composante avec la télécommande</b>	<ul style="list-style-type: none"> <li><input type="checkbox"/> Utilisez la télécommande de ladite composante.</li> </ul>
<b>Lorsque j'ai changé les piles, les numéros de code par défaut sont revenus</b>	<ul style="list-style-type: none"> <li><input type="checkbox"/> Vous devez reprogrammer la télécommande.</li> </ul>

## Video

Problème	Solutions possibles
<b>Aucune image, aucun son</b>	<ul style="list-style-type: none"> <li><input type="checkbox"/> Vérifiez que le cordon d'alimentation est branché.</li> <li><input type="checkbox"/> Si un voyant rouge clignote à l'avant de votre téléviseur pendant plusieurs minutes, débranchez, puis rebranchez le cordon d'alimentation pour réinitialiser le téléviseur. Si le problème persiste, contactez votre service après-vente local.</li> <li><input type="checkbox"/> Vérifiez les réglages TV/VIDEO : réglez sur TV lorsque vous regardez la télévision et réglez sur VIDEO 1, 2, 3, 4 ou 5 lorsque vous regardez un appareil vidéo (page 5).</li> <li><input type="checkbox"/> Vérifiez que les piles sont insérées correctement dans la télécommande (page 2).</li> <li><input type="checkbox"/> Essayez une autre chaîne, il peut s'agir d'un problème de station.</li> </ul>
<b>Aucune image ou image médiocre, bon son</b>	<ul style="list-style-type: none"> <li><input type="checkbox"/> Réglez l'image dans le menu Vidéo (page 32).</li> <li><input type="checkbox"/> Réglez la luminosité dans le menu Vidéo (page 32).</li> <li><input type="checkbox"/> Vérifiez les raccordements de l'antenne et/ou du câble (page 13).</li> </ul>
<b>Aucune couleur</b>	<ul style="list-style-type: none"> <li><input type="checkbox"/> Réglez la couleur dans le menu Vidéo (page 32).</li> </ul>
<b>Seulement de la neige apparaît sur l'écran</b>	<ul style="list-style-type: none"> <li><input type="checkbox"/> Vérifiez le réglage de Câble dans le menu Canal (page 35).</li> <li><input type="checkbox"/> Vérifiez les raccordements de l'antenne et/ou du câble (page 13).</li> <li><input type="checkbox"/> Vérifiez que la chaîne sélectionnée est en cours de diffusion.</li> </ul>
<b>Lignes en pointillés ou rayures</b>	<ul style="list-style-type: none"> <li><input type="checkbox"/> Réglez l'antenne.</li> <li><input type="checkbox"/> Eloignez le téléviseur des autres appareils électroniques. Certains appareils électroniques peuvent créer des parasites électriques susceptibles de perturber la réception du téléviseur.</li> </ul>
<b>Images doubles ou fantômes</b>	<ul style="list-style-type: none"> <li><input type="checkbox"/> Vérifier l'antenne extérieure ou contactez votre fournisseur de câblodistribution.</li> </ul>

## Audio

Problème	Solutions possibles
Bonne image, aucun son	<ul style="list-style-type: none"> <li><input type="checkbox"/> Appuyez sur  de sorte que Muting disparaisse de l'écran (page 3).</li> <li><input type="checkbox"/> Vérifiez vos réglages du son. Le téléviseur est peut-être réglé sur Auto SAP (page 34).</li> <li><input type="checkbox"/> Assurez-vous que l'option de haut-parleur est activée dans la menu Audio.</li> <li><input type="checkbox"/> Appuyez sur  pour régler le volume du téléviseur.</li> </ul>

## Canaux

Problème	Solutions possibles
Impossible de recevoir des canaux dont le numéro est élevé (UHF) avec une antenne	<ul style="list-style-type: none"> <li><input type="checkbox"/> Vérifiez que l'option <b>Câble</b> est réglée sur Non dans le menu Canal (page 35).</li> <li><input type="checkbox"/> Exécutez la fonction Auto programmation pour ajouter des chaînes qui ne sont pas enregistrées dans la mémoire (page 25).</li> </ul>
Il semble que certaines stations câblées ne fonctionnent pas.	<ul style="list-style-type: none"> <li><input type="checkbox"/> Vérifiez que l'option <b>Câble</b> est réglée sur Oui dans le menu Canal (page 35).</li> <li><input type="checkbox"/> Exécutez la fonction Auto programmation pour ajouter des chaînes qui ne sont pas enregistrées dans la mémoire (page 25).</li> </ul>
Je n'ai rien d'autre que la télévision	<ul style="list-style-type: none"> <li><input type="checkbox"/> Assurez-vous que vous n'avez pas défini, dans le menu Réglage (page 44), le vidéo pour ignorer les entrées vidéo. Si le réglage d'une entrée vidéo indique Ignorer, elle sera ignorée lorsque vous appuyez sur les touches TV/VIDEO, que ce soit pour les images principales ou PIP.</li> </ul>

## Picture in Picture (PIP)

Problème	Solutions possibles
La télécommande ne fonctionne pas en mode PIP	<ul style="list-style-type: none"> <li><input type="checkbox"/> Appuyez sur la touche FUNCTION TV. Vous avez peut-être appuyé accidentellement sur la touche VCR/DVD FUNCTION, ce qui fait passer les touches PIP en mode magnétoscope (page 28).</li> </ul>

Problème	Solutions possibles
<b>Aucune image ou seulement des parasites dans la fenêtre de l'image secondaire</b>	<ul style="list-style-type: none"> <li>❑ Vérifier que l'image secondaire est réglée sur une source ou un canal en cours de diffusion.</li> <li>❑ Il est possible qu'aucun appareil ne soit raccordé à l'entrée vidéo choisie. Passez en revue les entrées vidéo à l'aide de la touche jaune PIP TV/VIDEO dotée d'un point rouge (page 28).</li> </ul>
<b>L'émission de l'image secondaire est la même que celle de l'image principale</b>	<ul style="list-style-type: none"> <li>❑ Les deux images sont peut-être réglées au même canal. Changez le canal de l'une des deux images (page 28).</li> <li>❑ Le téléviseur est peut-être réglé pour la réception de tous les canaux par l'entremise d'un décodeur de câblodistribution. Le décodeur ne décode qu'un seul signal à la fois. De ce fait, il ne permet pas d'utiliser la fonction PIP. Si possible, raccordez le câble du câblodistributeur directement à la prise VHF/UHF du téléviseur. Cette mesure ne fonctionne que si votre câblodistributeur offre des canaux non brouillés (page 15).</li> </ul>
<b>Je ne vois pas VIDEO 4-5 (Y, Pb, Pr) dans le PIP</b>	<ul style="list-style-type: none"> <li>❑ Les appareils reliés dans VIDEO 4-5 (Y, Pb, Pr) ne sont pas visibles dans le PIP.</li> </ul>

### Pour communiquer avec Sony

Avant de téléphoner au centre de service à la clientèle, réinitialisez le téléviseur aux réglages par défaut (voir page 25). Veuillez prendre en note le numéro de série de votre téléviseur. Vous trouverez ce numéro à l'arrière du téléviseur et sur la couverture du présent guide.

Voici les numéros de téléphone des services à la clientèle : (416) 499-SONY (7669) (résidents canadiens seulement) ou 1-800-222-SONY (7669) (résidents américains seulement) .

## Spécifications

### Pour tous les modèles (sauf ceux portant la mention contraire)

Système de télévision	Norme de télévision américaine / NTSC		
Couverture des canaux	VHF : 2-13/UHF : 14-69/CATV : 1-125		
Antenne	Borne d'antenne externe de 75 ohms pour VHF/UHF		
Tube cathodique	Tube FD Trinitron®		
Alimentation	120 V, 60 Hz		
Accessoires fournis	Piles AA (R6) (2) Télécommande RM-Y181 (1)		
Entrées / sorties	Entrées	1 vidéo, 1 audio (devant) 2 vidéo, 2 audio (arrière) 2 S VIDEO (1 devant, 1 arrière) 2 RF 2 Y, Pb, Pr, 2 audio	Sorties  1 AUDIO OUT 1 MONITOR OUT
Accessoires en option	Meuble de téléviseur : SU-27F1 pour le KV-27FV310 SU-32F1 pour le KV-32FV310 SU-36F1 pour le KV-36FV310		

#### **KV-27FV310**

Taille de l'écran	Taille visible de l'écran : 679 mm (27 po) en diagonale Taille réelle de l'écran : 736,6 mm (29 po) en diagonale
Sortie du haut-parleur	7,5 W x 2, 15 W Subwoofer
Consommation électrique	215 W en fonctionnement 1 W en veille
Dimensions (W/H/D)	784 x 601,5 x 520 mm (30 <sup>7</sup> / <sub>8</sub> x 23 <sup>11</sup> / <sub>16</sub> x 20 <sup>1</sup> / <sub>2</sub> po)
Poids	50,4 kg (111 livres 1,7 onces)

#### **KV-32FV310**

Taille de l'écran	Taille visible de l'écran : 803 mm (32 po) en diagonale Taille réelle de l'écran : 863,6 mm (34 po) en diagonale
Sortie du haut-parleur	7,5 W x 2, 15 W Subwoofer
Consommation électrique	235 W en fonctionnement 1 W en veille
Dimensions (W/H/D)	898 x 682 x 584 mm (35 <sup>3</sup> / <sub>8</sub> x 26 <sup>7</sup> / <sub>8</sub> x 23 po)
Poids	79,1 kg (171 livres 15,3 onces)

#### **KV-36FV310**

Taille de l'écran	Taille visible de l'écran : 911 mm (36 po) en diagonale Taille réelle de l'écran : 965,2 mm (38 po) en diagonale
Sortie du haut-parleur	7,5 W x 2, 15 W Subwoofer
Consommation électrique	235 W sous tension 1 W en veille
Dimensions (W/H/D)	1020 x 760 x 640 mm (40 <sup>1</sup> / <sub>4</sub> x 30 x 25 <sup>1</sup> / <sub>4</sub> po)
Poids	103,4 kg (228 livres)

*La conception et les caractéristiques techniques sont sujettes à modification sans préavis.*



# Index

16:9 amélioré **44**

## A

Aigu **33**

Auto programmation **25, 36**

Auto SAP **34**

## B

Balance **33**

## C

Câble **35**

Canal fixe **36**

Canaux préférés **35**

Caption Vision (sous-titres) **44**

Caractéristiques du téléviseur **1**

Casque d'écoute sans fil

    Piles **2**

    PIP **28**

ClearEdge VM **32**

Couleur **32**

## D

Démo **44**

DISPLAY **5**

DynaBlack **32**

## E

Effet

    Non **33**

    Simulé **33**

    TruSurround **33**

    WOW **33**

Étiquette vidéo **44**

## G

Grave **28**

Guide de dépannage **47**

## H

Haut-parleur **34**

Heure **43**

## I

Image **32**

Image sur image (PIP) **28**

## L

Langue **44**

Légende de canal **31**

Luminosité **26**

## M

Menus

    Audio **33**

    De base **45**

    Heure **43**

    Parent **37**

    Canal **35**

    Vidéo **32**

Menu avancé **45**

Minuterie 1 et Minuterie 2 **43**

Mode

    Éclatant **32**

    Film **32**

    Pro **32**

    Standard **32**

MTS

    Auto SAP **34**

    Mono **34**

    Stéréo **34**

## N

Netteté **32**

Nuance **32**

## P

Panneau arrière du téléviseur **11**

Panneau avant du téléviseur **2**

## R

Raccordements

    Câble ou antenne **13**

    Décodeur de câble et câble **15**

    Raccordement d'une chaîne audio **22**

    Raccordement d'un caméscope **22**

    Raccordement d'un lecteur de DVD **21**

    Raccordement de deux

        magnétoscopes **20**

    Raccordement du téléviseur à un

        magnétoscope **16**

    Téléviseur et décodeur de câble **14**

    Téléviseur et récepteur satellite **19**

    Téléviseur, magnétoscope et décodeur  
    de câble **17**

    Téléviseur, récepteur satellite et  
    magnétoscope **20**

Réglage du classement

    Classement anglais **42**

Classement des films **40**

Classement français **42**

Classement de télé **40**

Classement U.S.A. **42**

Non-classée **41**

Rotation **44**

## **S**

Saut/Ajout canal **36**

SLEEP **3**

Sortie audio **34**

Spécifications **52**

## **T**

Télécommande

    Programmation **6**

Température de la couleur **32**

## **V**

Volume auto **33**



**FD Trinitron**  
**WEGA**<sup>®</sup>



**Manual de Instrucciones**

Lea este manual antes de operar el producto

# ADVERTENCIA

Para evitar el riesgo de incendio o descarga eléctrica, no exponga el televisor a la lluvia o humedad.



Este símbolo señala al usuario la presencia de voltaje peligroso sin aislamiento en el interior del aparato de tal intensidad que podría presentar riesgo de descarga eléctrica.



Este símbolo indica al usuario que el manual que acompaña a este aparato contiene instrucciones importantes referentes a su funcionamiento y mantenimiento.

## Nota para el instalador de CATV

Esta nota pretende llamar la atención del instalador del sistema CATV en relación con el artículo 820-40 de la NEC que proporciona las pautas para una adecuada conexión a tierra y, en particular, especifica que el cable de conexión a tierra debe estar conectado al sistema de toma de tierra del edificio lo más cerca posible de la entrada del cable.

## PRECAUCIONES DE SEGURIDAD

- Utilice el televisor con ca (corriente alterna) como se menciona a continuación para todos los países excepto en donde se indique:  
ca 120 V 60 Hz  
ca 220 V 50/60 Hz (Chile, Perú, Bolivia)
- Una terminal del enchufe es más ancha que la otra para garantizar la seguridad y solo se podrá introducir en la toma de corriente de una manera (sólo los modelos con ca 120 V). Si no puede insertar completamente el enchufe en la toma, póngase en contacto con su proveedor.
- Si se introduce algún objeto sólido o líquido en el televisor, desconéctelo y haga que sea revisado por personal especializado antes de volver a utilizarlo.

## PRECAUCION

PARA EVITAR DESCARGAS ELÉCTRICAS, INTRODUZCA EL ENCHUFE EN EL TOMACORRIENTE POR COMPLETO, CON EL CONTACTO ANCHO DEL ENCHUFE EN LA RANURA ANCHA DEL TOMACORRIENTE.

Al usar videojuegos, computadoras y productos similares con el televisor, mantenga los ajustes de brillo y contraste a un nivel moderado. Si una imagen inmóvil permanece en la pantalla durante un periodo prolongado con elevada intensidad de brillo o contraste, la imagen podría quedar grabada en la pantalla en forma permanente. Igualmente, ver continuamente el mismo canal de televisión podría dejar grabada en la pantalla el logotipo de la emisora. La garantía no cubre este tipo de anomalías, ya que se deben al mal uso del aparato.



Para reducir el riesgo de descarga eléctrica, no utilice el enchufe polarizado con un cable de extensión, un receptáculo ni otras tomas, a menos que las terminales estén bien insertadas y no queden expuestas.



Se advierte que cualquier cambio o modificación que no se apruebe de modo explícito en este manual podría anular su autorización para utilizar este equipo.

## NOTIFICACION

Este aparato ha sido debidamente probado, comprobándose que cumple con los límites impuestos a dispositivos digitales Clase B de acuerdo con la Sección 15 de las normas de la FCC. Estos límites se establecieron para ofrecer protección razonable contra interferencias perjudiciales en las instalaciones residenciales. Este aparato genera, u y puede emitir energía radioeléctrica. De no instalarse y utilizarse de acuerdo con las instrucciones correspondientes, podría producir interferencias perjudiciales en las radiocomunicaciones. No obstante, no puede garantizarse que no se produzcan estas interferencias en una instalación determinada. Si este aparato llega a interferir en la recepción de radio o televisión, lo que podrá comprobarse encendiendo y apagando el aparato, se recomienda al usuario intentar corregir la interferencia mediante una o más de las siguientes medidas:

- Reoriente o cambie de lugar las antenas receptoras.
- Aumente la distancia que separa este aparato del receptor afectado.
- Conecte el aparato en una toma de corriente de un circuito distinto al que esté conectado el receptor que está afectado.
- Consulte con el distribuidor o solicite los servicios de un técnico capacitado en radio y televisión. Cualquier cambio o modificación que no se detalla expresamente en el presente manual podría invalidar su autorización para emplear este aparato.

## Protección del televisor

- Para evitar el sobrecalentamiento interno, no obstruya los orificios de ventilación.
- No instale el televisor en un lugar con temperatura elevada, humedad, exceso de polvo o donde puedan producirse vibraciones.

## Nota sobre Caption Vision

Este receptor de televisión proporciona pantalla de televisión con visualización de subtítulos de acuerdo con el punto § 15.119 del reglamento de la FCC.

El uso del televisor con finalidades distintas a la visualización privada de emisiones de programas en UHF o VHF o transmisiones vía cable dirigidas al público en general puede requerir la autorización de la compañía de emisión por cable y/o del propietario del programa.

## Información para el propietario

Los números de serie y modelo están situados en la portada de este manual y en la parte posterior del televisor.

## Marcas comerciales y derechos de autor

ENERGY STAR® es una marca registrada.

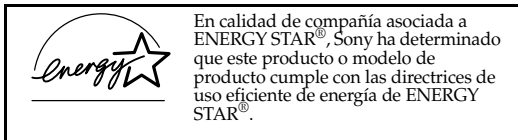

WEGA®, FD Trinitron, Caption Vision y IlluminaPoint™ son marcas registradas de Corporación Sony.

Con licencia de BBE Sound, Inc. bajo USP 4638258.4482866. BBE y el símbolo BBE son marcas comerciales de BBE Sound, Inc.

WOW, TruSurround y el símbolo (●)® son marcas comerciales de SRS Labs, Inc. La tecnología WOW se ha incorporado bajo licencia de SRS Labs, Inc.

# Normas importantes sobre seguridad

Para su protección, lea detenidamente estas instrucciones y guarde este manual para futuras consultas.

Lea cuidadosamente todas las advertencias y precauciones y siga las instrucciones inscritas en el televisor o descritas en el manual de instrucciones o de reparación.

## ADVERTENCIA

Para protegerse contra daños personales, siga las precauciones de seguridad básicas durante la instalación, la utilización y el mantenimiento del televisor indicadas a continuación.

## USO

### Fuentes de alimentación

Este televisor solamente deberá alimentarse con el tipo de fuente de alimentación indicado en la etiqueta de serie/modelo. Si no está seguro sobre el tipo de red eléctrica de su hogar, consulte a su proveedor o a la compañía de suministro eléctrico local. En caso de un televisor diseñado para alimentarse con baterías, consulte su manual de instrucciones.



### Conexión a tierra o polarización

Este aparato cuenta con cable eléctrico con clavija polarizada (con una terminal más ancha que la otra), o con tres terminales (la tercera es para la conexión). Siga las instrucciones indicadas a continuación:

#### Para los equipos con un enchufe de cable de alimentación de ca polarizado

El enchufe se introduce en la toma de corriente en una única dirección. Se trata de una característica de seguridad. Si no puede insertar completamente el enchufe en la toma, intente girar el enchufe. Si sigue teniendo problemas para insertar el enchufe, póngase en contacto con su electricista para que le instale una toma adecuada. No ponga a prueba la finalidad de seguridad del enchufe polarizado forzándolo.



#### Advertencia alternativa

#### Para los equipos con un enchufe de ca con tres cables de conexión de tierra

Este enchufe únicamente se acoplará a una toma de corriente de conexión a tierra. Se trata de una característica de seguridad. Si no puede insertar el enchufe en la toma, póngase en contacto con su electricista para que le instale una toma adecuada. No ponga a prueba la seguridad del enchufe de conexión a tierra.

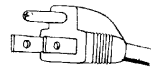

## Sobrecarga

No sobrecargue las tomas de pared, los cables de extensión ni los receptáculos más allá de su capacidad, puesto que podría producirse un incendio o una descarga eléctrica. Apague siempre el aparato cuando no lo utilice. Si no va a utilizar el aparato durante un tiempo prolongado, desconéctelo de la toma de pared como precaución ante la posibilidad de que se produzca un mal funcionamiento interno que pueda provocar un incendio.

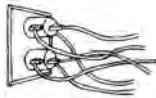

No desconecte la antena ni el cable de alimentación en caso de tormenta. Los relámpagos podrían descargar mientras sujeta el cable y provocarle lesiones graves. Apague el televisor y espere que el tiempo mejore.



## Introducción de objetos y líquidos

No introduzca objetos de ningún tipo a través de las ranuras del gabinete, ya que podrían tocar puntos de tensión peligrosa o provocar cortocircuitos de piezas, lo que podría resultar en incendios o descargas eléctricas. No derrame nunca ningún tipo de líquido sobre el televisor.



## Accesorios

No utilice ningún accesorio no recomendado por el fabricante, ya que podría ser peligroso. No coloque ningún tipo de objetos, especialmente objetos pesados, encima del aparato. Podrían caerse del aparato y causar lesiones.



## Limpieza

Antes de limpiar el televisor, desconéctelo de la alimentación. No utilice limpiadores líquidos ni aerosoles. Para limpiar el exterior del televisor, emplee un paño ligeramente humedecido en agua.



Si se produce un ruido continuo o intermitente en el interior del aparato de televisión mientras está en funcionamiento, desconecte el televisor y póngase en contacto con el proveedor o con el servicio de asistencia técnica. Es normal que algunos aparatos de televisión produzcan ocasionalmente este tipo de ruidos, especialmente cuando se conectan y desconectan.



## Instalación

Para levantar o mover el aparato siempre se deberá hacer entre dos o más personas. El aparato es pesado y la superficie inferior es plana. Si intenta mover el aparato sin ayuda o lo manipula de forma insegura, puede producirse lesiones graves. Instale el aparato sobre una superficie plana y estable.

## Agua y humedad

No utilice aparatos de alimentación eléctrica cerca del agua — por ejemplo, cerca de una bañera, un lavabo, un fregadero o una lavadora, en un sótano húmedo, ni cerca de una piscina, etc.



## Colocación

No coloque el televisor sobre una mesita con ruedas, un pedestal, una mesa o un estante inestable. El televisor podría caer, causando daños serios a niños, adultos y al propio televisor. Utilice solamente la mesita de ruedas o soporte recomendado por el fabricante para el modelo específico. La combinación de un televisor y un mueble con ruedas deberá moverse con cuidado. Las paradas bruscas, la fuerza excesiva y las superficies desiguales pueden hacer que el aparato y el mueble vuelquen.

Desconecte todos los cables del aparato antes de intentar moverlo.

No permita que niños o animales se suban encima del aparato o lo empujen. El aparato podría caerse y causar lesiones graves.



## Ventilación

Las ranuras y aberturas en la parte posterior o inferior del televisor son para permitir la ventilación necesaria. Para asegurar la operación fiable del televisor y protegerlo contra el sobrecalentamiento, estas ranuras y aberturas no deberán cubrirse ni bloquearse nunca.

❑ No tape las ranuras ni aberturas con paños ni otros materiales.



❑ No bloquee las ranuras ni aberturas colocando el televisor sobre una cama, sofá, alfombra u otras superficies similares.



- ❑ No coloque el televisor en un lugar cerrado, como en un librero o un mueble empotrado, a menos que esté adecuadamente ventilado.



- ❑ No coloque el televisor cerca, ni sobre un radiador o una salida de aire caliente, ni expuesto a la luz solar directa.



## Protección del cable de alimentación

No permita que ningún objeto quede sobre el cable de alimentación, ni coloque el televisor donde el cable pueda quedar sometido a desgaste o presión.

## Conexión a tierra o polarización

Este aparato puede estar equipado con un enchufe de línea de corriente alterna polarizado (con una terminal más ancha que la otra). El enchufe sólo se puede introducir en la toma de corriente en una dirección. Se trata de una característica de seguridad. Si no puede insertar completamente el enchufe en la toma, intente girarlo. Si sigue teniendo problemas para introducir el enchufe, póngase en contacto con su electricista para que sustituya la toma obsoleta. No ponga a prueba la seguridad del enchufe polarizado.

## Antenas

### Conexión a tierra de una antena exterior

Para instalar una antena exterior, siga los procedimientos que se indican a continuación. Los sistemas de antenas exteriores no deben situarse cerca de líneas eléctricas o circuitos de alimentación o luz eléctrica, o bien donde pueda entrar en contacto con dichas líneas eléctricas o circuitos.

**CUANDO INSTALE UN SISTEMA DE ANTENA EXTERIOR, EXTREME LAS PRECAUCIONES Y MANTÉNGALO ALEJADO DE DICHAS LINEAS ELÉCTRICAS O CIRCUITOS, DADO QUE EL CONTACTO PUEDE RESULTAR FATAL.**

Asegúrese de que el sistema de antena tiene conexión a tierra para proporcionar protección contra los incrementos de voltaje y el aumento de las cargas estáticas. El apartado 810 del Código Eléctrico Nacional (NEC) en EE.UU. y el apartado 54 del Código eléctrico de Canadá proporcionan información relativa a la conexión a tierra adecuada del mástil y de la estructura de soporte, la conexión a tierra del cable de conexión a la unidad de descarga de la antena, el tamaño de los conductores de la conexión a tierra, la ubicación de la unidad de descarga de la antena, la conexión de los electrodos de conexión a tierra y los requisitos de los electrodos de conexión a tierra.

### Conexión a tierra de la antena de acuerdo con el Código Eléctrico Nacional, ANSI/NFPA 70

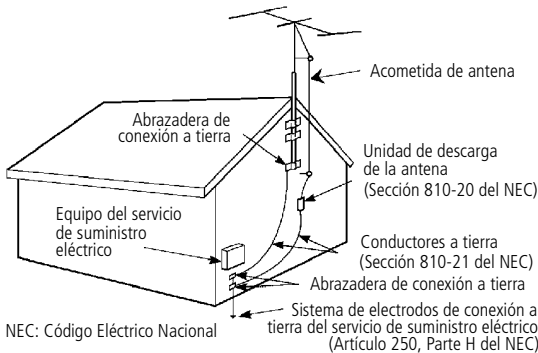

## Rayos

Para mayor protección del receptor de televisión durante una tormenta con rayos o cuando no se utiliza durante largos periodos de tiempo, desconéctelo de la toma de pared y desconecte la antena. Con ello evitará que los rayos y los incrementos de voltaje dañen el receptor.

## Reparación

### Daños que requieren reparación

Desconecte el aparato de la toma de pared y haga que sea revisado por personal calificado cuando se produzcan las siguientes condiciones:

- ❑ Si el cable de alimentación o el enchufe están dañados o deshilachados.

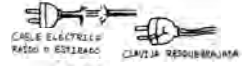

- ❑ Si se ha vertido líquido en el interior del aparato o si se han caído objetos en el interior del producto.



- ❑ Si el aparato se ha expuesto a lluvia o agua.



- ❑ Si el aparato se ha caído y ha sufrido golpes excesivos o si se ha dañado la unidad.



- ❑ Si el aparato no funciona con normalidad al seguir las instrucciones del manual. Ajuste solamente los controles que se especifican en el manual de instrucciones. El ajuste inadecuado de otros controles puede provocar daños y a menudo requerirá mucho trabajo por parte de un técnico calificado para restablecer el funcionamiento normal del aparato.



- ❑ Si el aparato muestra un cambio de rendimiento significativo, debe repararse.

### Asistencia técnica

No intente reparar por sí mismo el aparato ya que al abrir el gabinete se vería expuesto a tensiones peligrosas y otros riesgos. Solicite los servicios de personal de reparación calificado.

### Piezas de reemplazo

Si necesita piezas de reemplazo, asegúrese de que el técnico certifique por escrito que ha utilizado piezas de reemplazo especificadas por el fabricante con las mismas características que las piezas originales. El uso de piezas no autorizadas puede provocar incendios, descargas eléctricas y otros peligros.



### Comprobación de seguridad

Después de realizar cualquier reparación del aparato, solicite al técnico de la reparación que realice comprobaciones rutinarias de seguridad (como especifica el fabricante) para determinar si el aparato se encuentra en condiciones seguras de funcionamiento y certificarlo. Cuando el aparato llega al final de su vida útil, debe desecharse adecuadamente para evitar una explosión del tubo de la imagen. Consulte a un técnico de reparación calificado para depositar el aparato.



# GLOSARIO

Auto Volumen	Estabiliza el volumen
BBE	Reproduce las señales originales de audio de manera fiel, al añadir progresivamente un tiempo de demora a las frecuencias bajas para lograr un sonido natural
Caption Vision	Despliegue de subtítulos
CH	Canal
ClearEdge	Bordes definidos
Code set	Programación de códigos
Converter	Convertidor
Dynablack	Precisión del nivel de negro
Demo	Demostración
Display	Pantalla de visualización, Desplegar información (canal, hora)
DVD	Reproductor de DVD
Enter	Ingresar
Function	Función
Guide	Guía
In, Input	Entrada
IluminaPoint	Iluminación puntual
Jump	Alternador de canales
L	Izquierda (Left)
L/R	Izquierda/Derecha (Left/Right)
MTS	Sonido multicanal del Televisor
Muting	Silenciador
Out	Salida
Picture Mode	Visualización de la imagen
PIP	Imagen dentro de una imagen
Power	Función de encendido
R	Derecha (Right)
Reset	Restablecer, Reiniciar
SAP	Programa secundario de audio
Satellite	Satélite
Sleep	Apaga el Televisor automáticamente
System Off	Apagado de sistema
Tape	Toca cintas
UHF	Señal de televisión de frecuencias ultra altas
VCR	Videgrabadora
VHF	Señal de televisión de frecuencias altas
VM	Modulación de velocidad
WOW	Recrea los graves con mas fuerza y al mismo tiempo hace que los diálogos sean mas claros



# Contenido

## Introducción

Características del Televisor FD Trinitron WEGA® .....	1
Acerca de este manual .....	2
Baterías para el control remoto .....	2
Controles del Menús del panel frontal .....	2

## Uso del Control Remoto y Funciones

Descripción del Control Remoto .....	3
Programación del Control Remoto .....	5
Utilizado el control remoto de su Televisor para operar otros equipos .....	7

## Conexión del Televisor

Panel posterior del Televisor.....	9
Conexiones Básicas.....	11
Conexiones del Decodificador .....	12
Conexión de equipo adicional .....	14

## Funciones básicas del Televisor

Programación automática del Televisor.....	23
Acceso rápido a los menús .....	24
Uso de Imagen dentro de una Imagen (PIP) .....	26
Conexiones que pueden afectar el uso de Imagen dentro de una Imagen (PIP).....	28

## Uso de los Menús

Para acceder a un Menú .....	29
Uso del Menú de Video .....	30
Uso del Menú de Audio.....	31
Uso del Menú de Canal.....	33
Uso del Menú de Bloqueo de Canal.....	35
Uso del Menú de Timer (Reloj).....	36
Uso del Menú de Ajustes .....	37
Uso del Menú Básico .....	38

## Información Adicional

Solución de problemas.....	39
Especificaciones.....	42

Índice alfabético.....	43
------------------------	----

# Introducción

Gracias por la compra del Televisor FD Trinitron WEGA® de Sony. Antes de utilizar este manual, compruebe el número de modelo situado en la parte posterior del Televisor o en la portada de este manual.

## Características del Televisor FD Trinitron WEGA®

Algunas de las características que disfrutará son:

- ❑ **FD Trinitron CRT Plano** — Su cinescopio tecnológicamente avanzado ofrece una imagen con precisión absoluta y notable detalle.
- ❑ **Ilumina Point** — Tecnología que incrementa la luminosidad y enfoque para mejor calidad de imagen.
- ❑ **Entradas Y, P<sub>B</sub>, P<sub>R</sub>** — Conexión de entrada de video para una calidad de imagen superior. (480i únicamente).
- ❑ **WOW** — Una nueva función de audio que proporciona un excelente sonido con bajos profundos e intensos. Al activar WOW, BBE se activa directamente para mejorar aún más el programa de audio.
- ❑ **TruSurround** — Produce un sonido tridimensional dinámico en las señales audio estéreo.
- ❑ **BBE** — Reproduce las señales originales de audio de manera fiel, al añadir progresivamente un tiempo de demora a las frecuencias bajas para lograr un sonido natural.
- ❑ **Función de bloqueo de canales** — Una herramienta para ayudar a que los padres controlen lo que ven sus hijos bloqueando algunos canales.
- ❑ **ClearEdge VM**—Aumenta la definición de la imagen al proporcionar un contorno limpio y nítido a los objetos.
- ❑ **DynaBlack** — Mejora el contraste y hace más nítidos los detalles de las imágenes.
- ❑ **Imagen dentro de una Imagen (PIP)**— Le permite ver dos canales al mismo tiempo.
- ❑ **Canales Favoritos** — Acceso instantáneo a sus canales favoritos con sólo presionar un botón.
- ❑ **Info** — Una función práctica que muestra el nombre y el tiempo restante del programa en curso, si la información está disponible.
- ❑ **Control Remoto Universal** — Puede programar el control remoto para operar con él su Decodificador de cable, Videograbadora, receptor de satélite digital o reproductor de DVD.
- ❑ **Energy Star®** — Cumple con las directivas Energy Star de eficiencia en el uso de la energía eléctrica.
- ❑ **Controles del Panel Frontal** — Permiten el acceso a los Menús de pantalla sin el control remoto.
- ❑ **Entradas de A/V frontales** — Conexión rápida para videojuegos, cámaras de video y equipos estéreo/mono.
- ❑ **Silenciamiento automático** — Función diseñada para silenciar automáticamente el Televisor cuando no se reciben señales.

## Acerca de este manual

Este manual proporciona instrucciones para ayudarle a disfrutar de su nuevo Televisor. Muestra como conectarlo a la antena o el cable, al Decodificador de cable, a la Videograbadora, al reproductor de DVD, al receptor de satélite, al sistema estéreo o a la cámara de video. Una vez conectado, siga las instrucciones y utilice el control remoto para acceder a los menús de pantalla.

## Baterías para el control remoto

Introduzca dos baterías de tipo AA (R6) (incluidas) en el control remoto como se muestra en la siguiente ilustración.

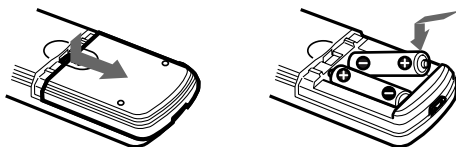

✎ En condiciones de uso normales, las baterías tienen una duración máxima de seis meses. Si el control remoto no funciona correctamente, es posible que las baterías estén gastadas.

✎ Si no va a utilizar el control remoto durante largo tiempo, quite las baterías para evitar posibles daños por fugas.

## Controles del Menú del panel frontal

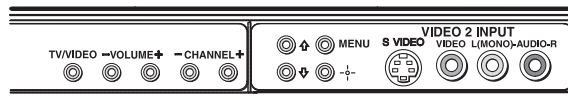

Los controles del panel frontal de audio/video le permiten acceder al Menú sin utilizar el control remoto.

- ❑ Presione para que aparezca el menú en pantalla.
- ❑ Use los botones y del panel frontal de audio/video en lugar del control remoto.
- ❑ Utilice el botón del panel frontal de audio/video para navegar a través de los menús y después seleccione una opción. Los controles del panel frontal también le permiten cambiar los canales, ajustar el volumen y cambiar las entradas de video.

✎ Para navegar por los menús con el control remoto, consulte "Uso de los Menús" en la página 29.

# Uso del Control Remoto y Funciones

## Descripción del Control Remoto

Esta sección le muestra cómo utilizar todos los botones del control remoto.

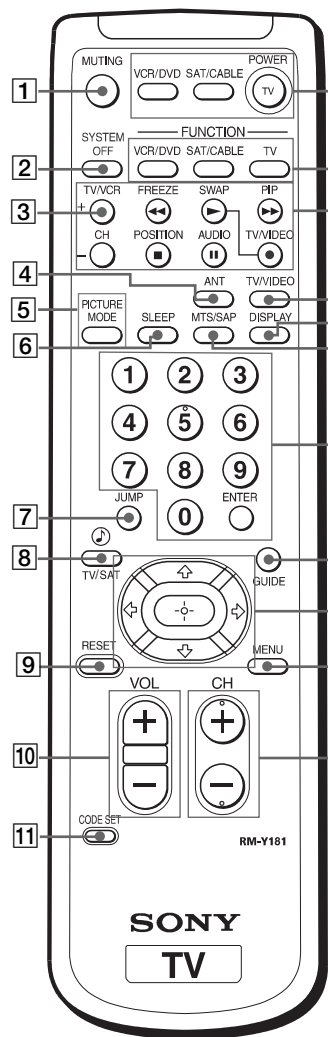

Botón	Descripción
1 <b>MUTING</b> <i>Silenciamiento automático</i>	Presione para desactivar el sonido. Presiónelo de nuevo o presione $\text{VOL} \uparrow$ para restaurar el sonido.
2 <b>SYSTEM OFF</b> <i>Apagar sistema</i>	Presiónelo para apagar todos los aparatos que estén programados en el control remoto, consulte "Programación del control remoto" en la página 5.
3 <b>TV/VCR</b>	Presiónelo para cambiar entre los modos de televisión y Videograbadora. Si su Videograbadora no es marca Sony, tendrá que programar el control remoto para que pueda reconocer su Videograbadora. Para más detalles, consulte "Programación del control remoto" en la página 5.
4 <b>ANT (antena)</b>	Presiónelo para cambiar la entrada de VHF/UHF a AUX.
5 <b>PICTURE MODE</b> <i>Modo de imagen</i>	Presione repetidamente para recorrer las modalidades de imagen disponibles: Vívido, Estándar, Película y Pro. Esta función se encuentra también en el Menú de Video. Consulte "Uso del Menú de Video" en la página 30.
6 <b>SLEEP</b> <i>Apagado automático</i>	Presione repetidamente hasta que aparezca el número de minutos (15, 30, 45, 60 o 90) que quiera tener encendido el Televisor antes de apagarse automáticamente. Para cancelar este modo, presione el botón hasta que aparezca Sleep No. Estando activado el modo de Sleep, presiónelo una vez para ver el tiempo restante.
7 <b>JUMP</b> <i>Alternar</i>	Presione para alternar entre dos canales. El Televisor cambia del canal actual al último canal seleccionado.
8 <b>TV/SAT</b>	Presione para alternar entre las entradas TV y SAT (satélite) cuando esté en modo SAT de la barra FUNCTION (función).
	Presione para acceder directamente a los ajustes de Efecto de Audio, cuando el control remoto esté en modo TV de la barra FUNCTION (función). Consulte "Uso del Menú de Audio" en la página 31 para más detalles.
9 <b>RESET</b> <i>Restablecer</i>	Presiónelo para volver a la configuración de fábrica cuando esté en un menú de pantalla.
10 <b>VOL (volumen)</b>	Presione (+) o (-) para ajustar el volumen.
11 <b>CODE SET</b> <i>Juego de códigos</i>	Programe con él su control remoto para que pueda operar el equipo de video conectado al Televisor, consulte "Programación del Control Remoto" en la página 5.
12 <b>Botones POWER</b> <i>Botones de encendido/apagado</i>	Presiónelos para encender y apagar su Televisor o el equipo conectado de audio/video que tenga programado en el control remoto, consulte "Programación del Control Remoto" en la página 5.

Botón	Descripción
<b>13</b> Botones <b>FUNCTION</b> <i>Botones de función</i>	Presiónelos para seleccionar el equipo conectado (Televisor, Videgrabadora/reproductor de DVD, receptor de satélite/cable) que desee utilizar con el control remoto.
<b>14</b> <b>PIP (Imagen dentro de una Imagen)</b>	Presiónelos para operar la función PIP. Consulte "Uso de Imagen dentro de una Imagen (PIP)" en la página 26.
<b>VCR (Funcionamiento)</b>	Presione para operar su Videgrabadora. La Videgrabadora deberá estar programada en el control remoto, consulte "Programación del control remoto" en la página 5.
<b>● y ► (para grabar)</b>	Presione el botón ● y el botón ► al mismo tiempo para grabar programas con su Videgrabadora (el control remoto debe haberse programado para poder utilizar esta opción).
<b>►</b>	Reproducir.
<b>◀◀</b>	Regresar.
<b>▶▶</b>	Avance rápido.
<b>■</b>	Parar.
<b>  </b>	Pausa. Presiónelo de nuevo para reanudar la reproducción normal.
<b>15</b> <b>TV/VIDEO</b>	Presiónelo para alternar entre las entradas de video disponibles.
<b>16</b> <b>DISPLAY</b> <i>Mostrar</i>	Presione una vez para ver la hora actual, el nombre del canal (si se ha definido) y el número del canal. Presiónelo nuevamente para desactivar la función. Consulte "Uso del Menú de Timer (Reloj)" en la página 36 para conocer más detalles.
<b>17</b> <b>MTS/SAP</b>	Presiónelo para recorrer las opciones de Sonido Multicanal del Televisor (MTS): Estéreo, Mono y Auto SAP (Segundo Programa de Audio).
<b>18</b> Botones <b>0-9</b> y <b>ENTER (introducir)</b>	Presiónelos para cambiar los canales directamente. El canal cambia después de 2 segundos.
<b>19</b> <b>GUIDE</b> <i>Guía</i>	Presiónelo para mostrar la guía de programas de su antena de satélite.
<b>20</b>	Presione los botones con flechas para mover el cursor en los menús en pantalla. Presione el botón central para seleccionar una opción o acceder a ella.
<b>21</b> <b>MENU</b>	Presione este botón para ver el Menú en pantalla. Presiónelo de nuevo para salir del Menú en cualquier momento.
<b>22</b> <b>CH (canal)</b>	Presione para cambiar de canal. Para navegar rápidamente a través de los canales, presione y manténgase así el botón CH+ o CH-.

 Para obtener información sobre los botones de operación de Imagen dentro de una Imagen (PIP), consulte la página 26.

 Si pierde su control remoto, consulte la página 5.



## Programación del Control Remoto

Para usar el Control Remoto con otro equipo necesita programar su control remoto. Use el siguiente procedimiento para programarlo.



**1** Consulte la lista de “Códigos del Fabricante” en la página 6 y busque el código de tres dígitos que corresponden a su componente (si más de un código aparece en la lista, utilice la primera opción).

**2** Presione .

 El botón  y  se enciende cuando se presiona el botón .

**3** Para indicar el tipo de componente que quiere programar con el control remoto presione  o  botón que están en la barra de FUNCTION.

 Debe hacer el paso número 4 antes de 10 segundos de haber realizado el punto 3, de lo contrario deberá hacer de nuevo el paso 2 y 3.

**4** Use los botones del - para programar los tres dígitos que corresponden al código del fabricante.

**5** Presione .

**6** Para verificar que el código funciona, apunte el control remoto hacia al componente y presione el botón verde de POWER (encendido) que corresponde al aparato. Si este responde habrá terminado, de lo contrario intente usar los otros códigos que corresponden al fabricante.

 Si tiene algún problema al programar su control remoto vea la sección de "Solución de Problemas" de este manual en la página 39.

## Códigos del Fabricante

### Videgrabadora

Sony	301, 302, 303
Admiral (M. Ward)	327
Aiwa	338, 344
Audio Dynamic	314, 337
Broksonic	319, 317
Canon	309, 308
Citizen	332
Craig	302, 332
Criterion	315
Curtis Mathes	304, 338, 309
Daewoo	341, 312, 309
DBX	314, 336, 337
Dimensia	304
Emerson	319, 320, 316, 317, 318, 341
Fisher	330, 335
Funai	338
General Electric	329, 304, 309
Go Video	322, 339, 340
Goldstar	332
Hitachi	306, 304, 305, 338
Instant Replay	309, 308
JC Penney	309, 305, 304, 330, 314, 336, 337
JVC	314, 336, 337, 345, 346, 347
Kenwood	314, 336, 332, 337
LXI (Sears)	332, 305, 330, 335, 338
Magnavox	308, 309, 310
Marantz	314, 336, 337
Marta	332
Memorex	309, 335
Minolta	305, 304
Mitsubishi/MGA	323, 324, 325, 326
Multitech	325, 338, 321
NEC	314, 336, 337

Optimus	327
Orion	217
Panasonic	308, 309, 306, 307
Pentax	305, 304
Philco	308, 309
Pioneer	308
Quasar	308, 309, 306
RCA/PROSCAN	304, 305, 308, 309, 311, 312, 313, 310, 329
Realistic	309, 330, 328, 335, 324, 338
Sansui	314
Samsung	322, 313, 321
Sanyo	330, 335
Scott	312, 313, 321, 335, 323, 324, 325, 326
Sharp	327, 328
Signature 2000 (M. Ward)	338, 327
SV2000	338
Sylvania	308, 309, 338, 310
Symphonic	338
Tashiro	332
Tatung	314, 336, 337
Teac	314, 336, 338, 337
Technics	309, 308
Toshiba	312, 311
Wards	327, 328, 335, 331, 332
Yamaha	314, 330, 336, 337
Zenith	331

### Reproductores de Discos Láser

Sony	701
Panasonic	704, 710
Pioneer	720

### Decodificadores

Sony	230
Hamlin/Regal	222, 223, 224, 225, 226

### Reproductores de DVD

Sony	751
General Electric	755
Hitachi	758
JVC	756
Magnavox	757
Mitsubishi	761
Oritron	759
Panasonic	753
Philips	757
Pioneer	752
RCA/Proscan	755
Samsung	758

### Decodificadores









Jerrold/G.I./Motorola	201, 202, 203, 204, 205, 206, 207, 208, 218
Oak	227, 228, 229
Panasonic	219, 220, 221
Pioneer	214, 215
Scientific Atlanta	209, 210, 211
Tocom	216, 217
Zenith	212, 213

### Receptores Satelitales









Sony	801
DIRECT TV	809
Dish Network	810
Echostar	810
General Electric	802
Hitachi	805
Hughes	804
Mitsubishi	809
Panasonic	803
RCA/PROSCAN	802, 808
Toshiba	806, 807

## Utilizando el control remoto de su Televisor para operar otros equipos





### Uso de una Videograbadora

Presione	Para
	Encender la Videograbadora (botones en verde)
	Seleccionar los canales directamente
	Cambiar de canal
	Reproducir cintas de video
	Detener el funcionamiento
	Desplazarse hacia adelante o hacia atrás
	Poner en pausa
 (Simultáneamente)	Grabar
	Alternar entre las entradas TV y VCR

### Uso de un Reproductor de DVD









Presione	Para
	Encender el reproductor de DVD (botones en verde)
	Seleccionar capítulos directamente
	Buscar capítulos hacia adelante o hacia atrás
	Reproducir un DVD
	Detener el funcionamiento
	Poner en pausa
	Mostrar el Menú del DVD
	Utilizar las flechas para desplazarse en el Menú y el botón de en medio para seleccionar.

### Uso de un Reproductor de Discos Láser





Presione	Para
	Encender el reproductor de discos láser (botones en verde)
	Buscar capítulos hacia adelante o hacia atrás
	Reproducir discos
	Detener el funcionamiento
	Poner en pausa



## Con un Receptor Satelital

Presione	Para
	Encender el Receptor Satelital
	Seleccionar un canal
	Cambiar de canal
	Volver al canal anterior
	Cambiar la modalidad de entrada
	Ver el numero de canal
	Ver la guía SAT
	Ver el menú SAT
	Utilizar las flechas para desplazarse en el Menú y el botón de en medio para seleccionar.

## Con un Decodificador

Presione	Para
	Encender el Decodificador
	Seleccionar un canal
	Cambiar de canal
	Volver al canal anterior

# Conexión del Televisor

Lea esta sección antes de instalar el Televisor por primera vez. Esta sección hace referencia a las conexiones básicas, así como a cualquier otro equipo opcional que conecte.

## Panel posterior del Televisor

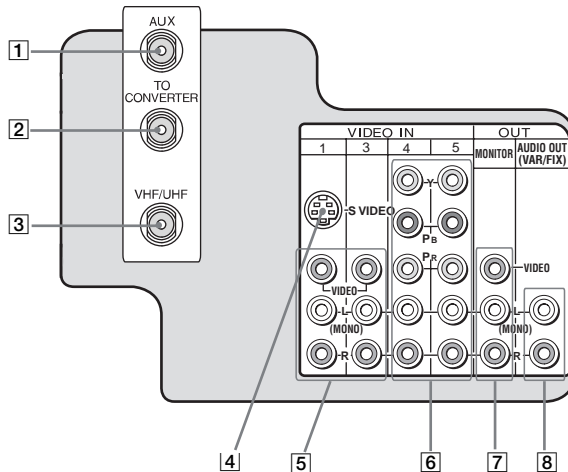

Toma	Descripción
1 <b>AUX</b>	Le permite ver los canales locales y de cable. Si su servicio de cable no ofrece los primeros, usted puede cambiar entre los canales locales y los del cable si oprime ANT en el control remoto. Los aparatos conectados a la entrada AUX no podrán verse en Imagen dentro de una Imagen (PIP).
2 <b>TO CONVERTER</b>	Ésta es una salida de VHF/UHF que le permite programar su Televisor para cambiar entre canales codificados (mediante un Decodificador) y los canales normales de televisión por cable. Use esta salida en lugar de un conector en Y para obtener una mejor calidad de imagen cuando necesite cambiar entre canales de cable codificados y decodificados.
3 <b>VHF/UHF</b>	Establece una conexión con el cable o la antena de VHF/UHF.
4 <b>S VIDEO</b>	Establece una conexión con la toma S VIDEO OUT (salida de S VIDEO) de la Videgrabadora o de otro equipo de video con S VIDEO. S VIDEO proporciona una mejor calidad de imagen que las tomas VHF/UHF o la toma de entrada de video. Como S VIDEO no proporciona sonido, debe mantener conectados los cables de audio.

Toma	Descripción
<b>5 VIDEO/AUDIO (L/R)</b>	Establece una conexión con las tomas de salida de AUDIO/VIDEO de la Videgrabadora o de otro equipo de video. En el panel frontal del Televisor existe una tercera toma de entrada de video (VIDEO 2). Estas tomas de entrada de AUDIO/VIDEO proporcionan una mejor calidad de imagen que la toma VHF/UHF.
<b>6 Y, P<sub>B</sub>, P<sub>R</sub>/ L, R</b>	Se conecta a las tomas de entrada de video para componentes Y, P <sub>B</sub> , P <sub>R</sub> y las tomas AUDIO L y R del reproductor de DVD o la caja Decodificadora digital (480i únicamente).
<b>7 MONITOR OUT</b>	Le permite grabar en la Videgrabadora el programa que está viendo. Cuando hay dos Videgrabadoras conectadas (consulte "Conexión de dos Videgrabadoras para grabar cintas" en la página 21), puede utilizar el Televisor como monitor para editar de cinta a cinta.
<b>8 AUDIO OUT (VAR/FIX) L(MONO)/R</b>	Se conecta a las tomas de entrada AUDIO L y R del equipo de audio. Puede escuchar el sonido del Televisor con el equipo de sonido.

## Conexiones Básicas

### Televisión con Decodificador o Antena Exterior o Interior

Dependiendo del sistema de Decodificador disponible en su casa, elija una de las siguientes opciones:

El Televisor puede estar conectado ya sea al Decodificador o a la antena con un cable de 75-ohms (usualmente ya instalado en casas nuevas).

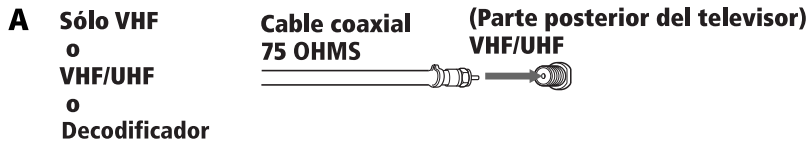

Este puede ser utilizado para conectar el Televisor a una antena dipolo, también conocida como antena de conejo (usualmente encontrada en casa viejas).

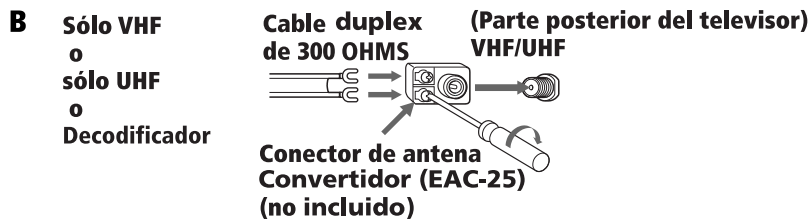

Esto le permite conectar su Televisor a ambas, a un sistema de Decodificador y a una antena dipolo, en orden de poder usar ambas el Decodificador y los canales locales.

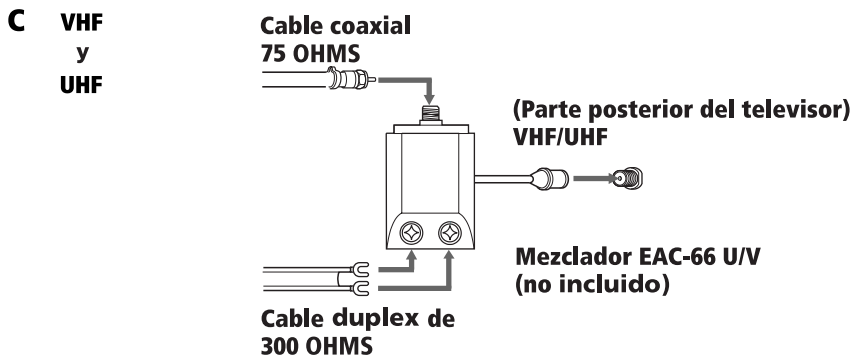

Si conecta el Televisor a una antena interior o exterior, es posible que deba ajustar la orientación de la antena para obtener una mejor recepción.

## Conexiones del Decodificador

Algunos sistemas de televisión por cable usan señales codificadas que requieren de un Decodificador para poder ver todos los canales. Si está suscrito a ese tipo de servicio de cable, utilice esta conexión. Las señales codificadas que lleguen al Televisor desde el Decodificador no pueden verse en Imagen dentro de una Imagen (PIP). Si algunos de sus canales están codificados, tome en consideración la posibilidad de utilizar la conexión de Decodificador y cable.

### Televisor y Decodificador

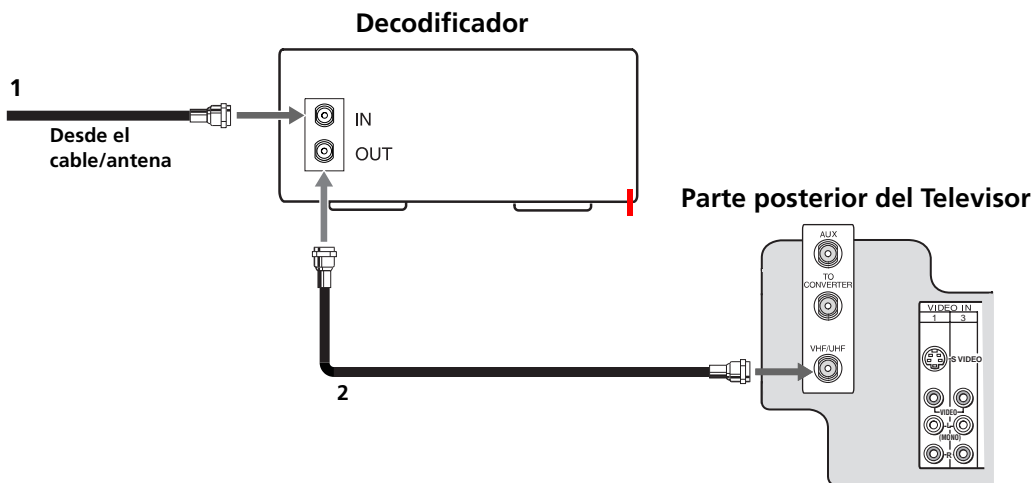

- 1 Conecte el cable coaxial de su servicio de cable a la toma IN del Decodificador.
- 2 Conecte un cable coaxial (no incluido) desde la toma OUT del Decodificador a la toma VHF/UHF del Televisor.

### Utilizando su Televisor con estas conexiones

Esta conexión le permite hacer lo siguiente:

- ❑ Programar su control remoto Sony para operar su Decodificador (ver página 5).
- ❑ Para activar su remoto presione  para operar su Decodificador, use los botones del - o el botón CH+/- para cambiar los canales. Para hacer esto, primero programe su control remoto, entonces use la función de Fijar Canal para programar su Televisor al canal 3 o 4 (ver página 33).

## Decodificador y cable

Utilice esta conexión si está suscrito a un sistema de cable que codifique algunos canales (canales de pago) pero no todos. Esta configuración le permite utilizar el control remoto para:

- ❑ Cambiar de canal por medio del Decodificador cuando esté recibiendo una señal codificada.
- ❑ Cambiar de canal por medio de su Televisor.

Esta conexión también le permite utilizar la función Imagen dentro de una Imagen (PIP) cuando esté viendo canales no codificados que lleguen directamente a su Televisor por el cable. Las señales codificadas que lleguen desde el Decodificador no pueden verse en Imagen dentro de una Imagen (PIP). Para obtener más información sobre la función Imagen dentro de una Imagen (PIP), consulte la página 26.

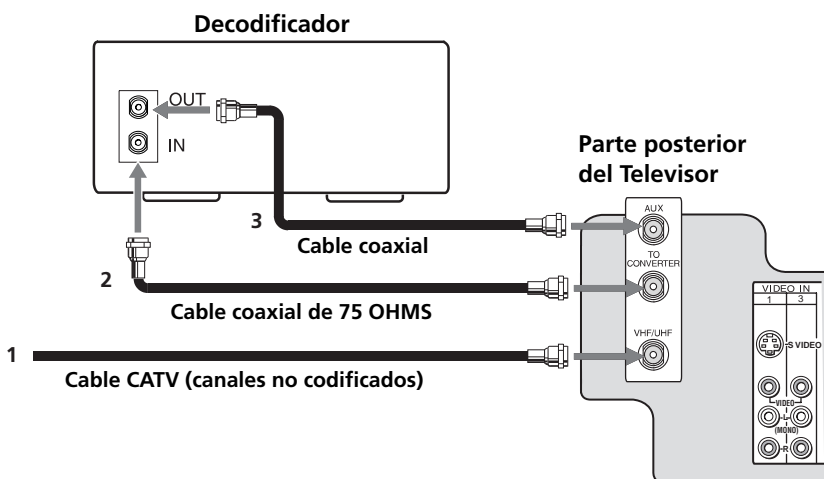

- 1** Conecte el cable coaxial del servicio de cables a la toma VHF/UHF del Televisor.
- 2** Conecte la toma IN del Decodificador a la toma TO CONVERTER del Televisor mediante un cable coaxial (no incluido).
- 3** Conecte la toma OUT del Decodificador a la toma AUX del Televisor mediante un cable coaxial (no incluido).

### Utilizando su Televisor con estas conexiones

Esta conexión le permite hacer lo siguiente:

- ❑ Programar su control remoto Sony para operar su Decodificador (ver página 5).
- ❑ Para activar su remoto presione para operar su Decodificador; use los botones del o el botón CH+/- para cambiar los canales. Para hacer esto, primero programe su control remoto, entonces use la función de Fijar Canal para programar su televisión al canal 3 o 4 (ver página 33).
- ❑ Presione para cambiar hacia delante y hacia atrás entre VHF/UHF (canales locales o canales codificados) y AUX (sistema de cable o de pago).

## Conexión de equipo adicional

### Conexión de un Televisor y una Videgrabadora

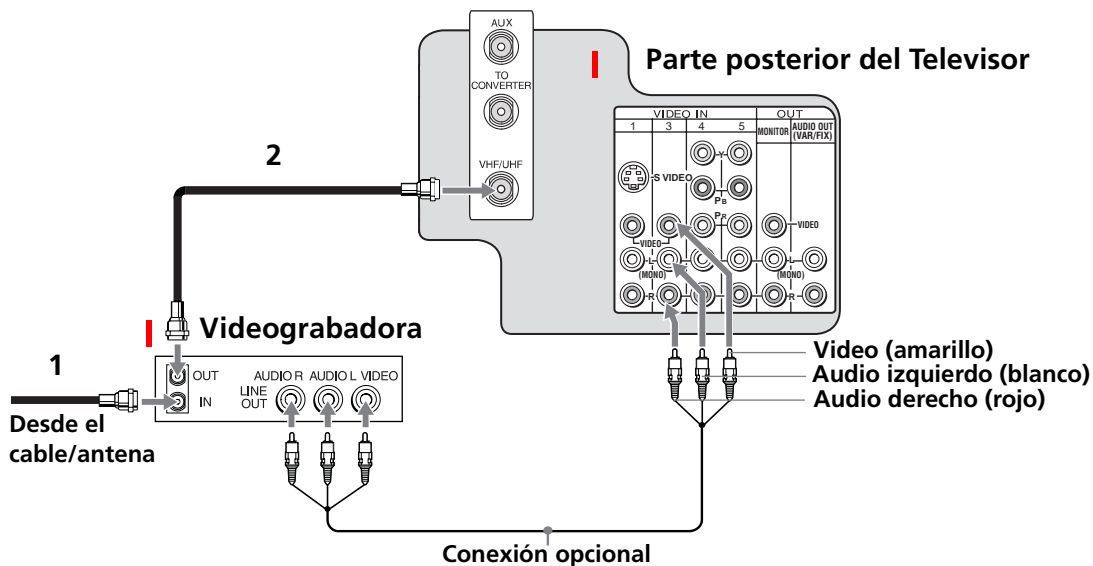



- 1** Conecte el cable coaxial de la antena del Televisor o del servicio de cable a la toma IN de la Videgrabadora.
- 2** Conecte el cable coaxial (no incluido) de la toma OUT de la Videgrabadora a la toma VHF/UHF del Televisor.

#### Conexión opcional

- Si la Videgrabadora dispone de salidas de video, puede obtener una mejor calidad de imagen conectando los cables de audio/video (no incluidos) desde la salida AUDIO/VIDEO OUT de la Videgrabadora a la toma AUDIO/VIDEO IN del Televisor.
- Para obtener una mejor calidad de imagen, utilice S VIDEO en lugar del cable amarillo de video. Como S VIDEO no proporciona sonido, debe mantener conectados los cables de audio.

#### Utilizando su Televisor con estas conexiones

Esta conexión le permite hacer lo siguiente:

- Programar su control remoto Sony para operar su Videgrabadora (ver página 5).
- Para activar su remoto presione  para operar su Videgrabadora, ver página 7 en como operar otras funciones. Para hacer esto, primero programe su control remoto, entonces use la función de Fijar Canal para programar su televisión al canal 3 o 4 (ver página 33).
- Presione  repetidas veces para cambiar entre la toma de la Videgrabadora (VIDEO input) y VHF/UHF (canales locales).

## Conexión de un Televisor, una Videgrabadora y un Decodificador

Utilice esta conexión si está suscrito a un sistema de cable que codifique algunos canales (canales de pago) pero no todos. Esta configuración le permite utilizar el control remoto para:

- ❑ Cambiar de canal con el Decodificador o la Videgrabadora mientras recibe una señal codificada.
- ❑ Cambiar de canal con el Televisor.

Esta conexión también le permite utilizar la función Imagen dentro de una Imagen (PIP) mientras ve canales no codificados que lleguen directamente a su Televisor por el cable. Las señales codificadas que lleguen desde el Decodificador no pueden verse en Imagen dentro de una Imagen (PIP). Para obtener más información sobre la función Imagen dentro de una Imagen (PIP), consulte la página 26.

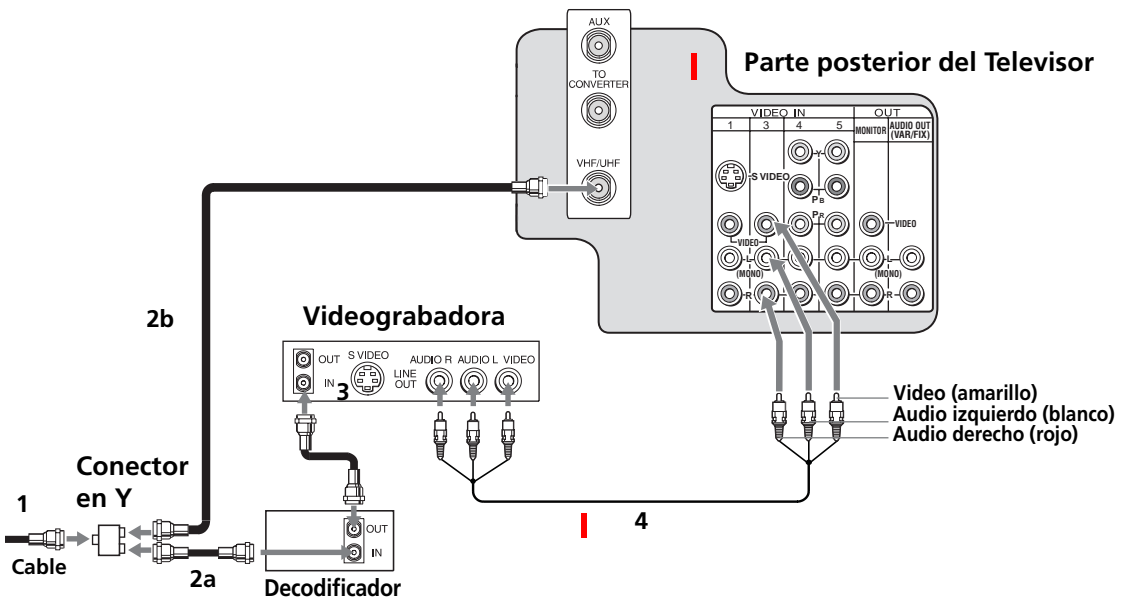



- 1** Conecte la toma de entrada del conector en Y a su conexión de cable de entrada.
- 2** Con un cable coaxial (no incluido), conecte las dos tomas de salida del conector en Y a:
  - a)** La toma IN del Decodificador.
  - b)** La toma VHF/UHF del Televisor.
- 3** Conecte la toma OUT del Decodificador a la toma IN de la Videgrabadora con un cable coaxial (no incluido).
- 4** Si la Videgrabadora tiene salidas de video, podrá obtener una mejor calidad de imagen si conecta los cables de audio / video (no incluidos) desde la salida AUDIO / VIDEO OUT de la Videgrabadora a la toma de entrada de AUDIO / VIDEO IN del Televisor.



- ❑ Para obtener una mejor calidad de imagen, utilice S VIDEO en lugar del cable amarillo de video. Como S VIDEO no proporciona sonido, debe mantener conectados los cables de audio.

### Utilizando su Televisor con estas conexiones

Estas conexiones le permiten hacer lo siguiente:

- ❑ Para usar el codificador para cambiar canales, programe el Televisor al canal 3 o 4. Use la función de fijar canal para asegurar que no cambie de canal accidentalmente (ver página 33).
- ❑ Programar su control remoto Sony para operar su Videgrabadora o Decodificador (ver página 5).
- ❑ Para activar su control remoto presiona  para operar su video casetera o  botón para operar su Decodificador, ver página sobre como operar otras funciones dependiendo del equipo que quiera usar.
- ❑ Presione  varias veces para cambiar entre la toma de la Videgrabadora, (VIDEO input), VHF/UHF (canales locales o canales codificados) o su Decodificador (sistema de cable o canales codificados).

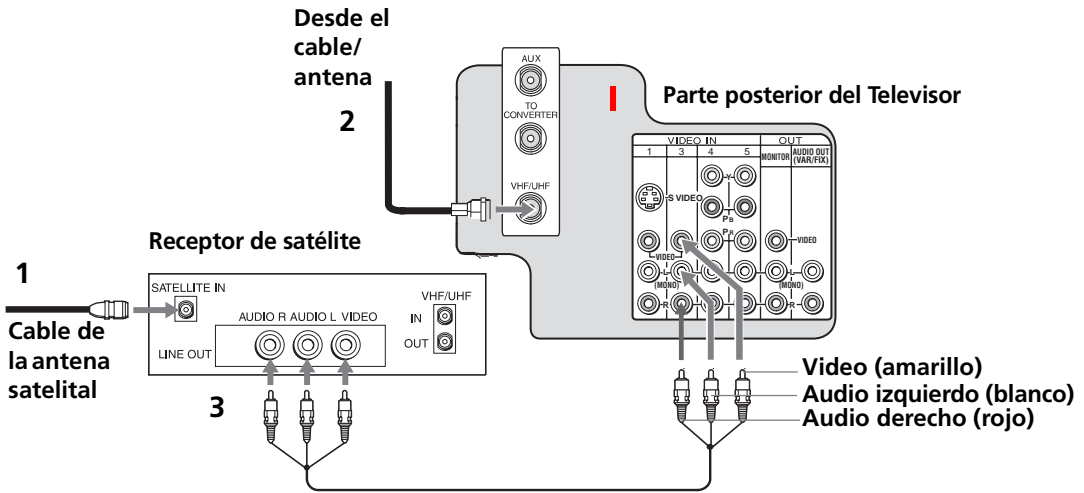

## Conexión de un Televisor y un Receptor de Satélite



- 1 Conecte el cable de la antena por satélite a la toma de SATELLITE IN del receptor de satélite.
- 2 Conecte el cable coaxial del servicio de cable o antena a la toma VHF/UHF del Televisor.
- 3 Use cables de audio/video (no incluidos) para conectar las tomas AUDIO/VIDEO OUT del receptor de satélite a la toma de AUDIO/VIDEO IN del Televisor.

### Utilizando su Televisor con estas conexiones

Esta conexión le permite hacer lo siguiente:

- Programar su control remoto Sony para operar su receptor de satélite (ver página 5).
- Para activar su control remoto para operar su receptor de satélite presiona  , (ver página 8), sobre como operar otras funciones dependiendo del equipo que quiere usar.
- Presione  repetidas veces para cambiar entre la toma del receptor de satélite (VIDEO input).

## Conexión de un Televisor, Videgrabadora y un Receptor de Satélite

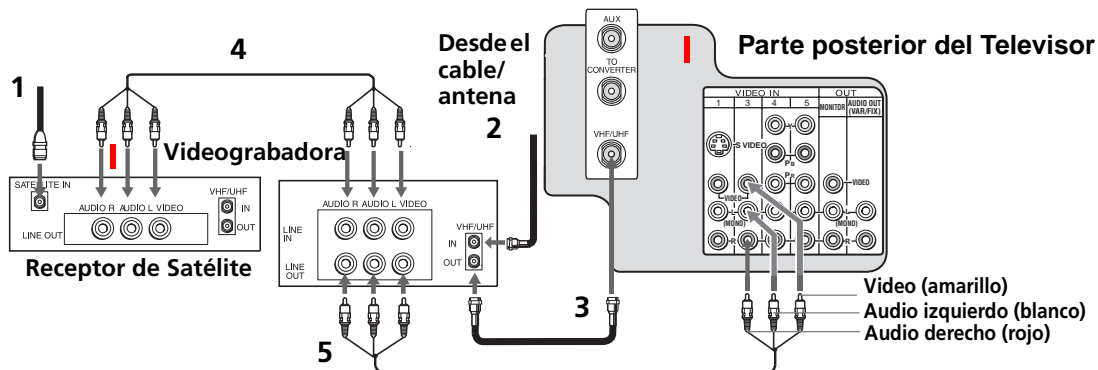



- 1** Conecte el cable de la antena por satélite a la entrada SATELLITE IN del Receptor de Satélite.
- 2** Conecte el cable coaxial del servicio de cable o antena a la toma IN de la Videgrabadora.
- 3** Conecte la toma OUT de la Videgrabadora a la toma VHF/UHF del Televisor con un cable coaxial (no incluido).
- 4** Use cables de audio/video (no incluidos) para conectar las tomas de AUDIO/VIDEO OUT del Receptor de Satélite a la toma de AUDIO/VIDEO IN de la Videgrabadora.
- 5** Conecte las tomas AUDIO/VIDEO OUT de la Videgrabadora a las tomas AUDIO/VIDEO IN del Televisor con cables de audio/video (no incluidos).

 Para ver las imágenes desde el Receptor de Satélite o la Videgrabadora, seleccione la entrada de video a la que esté conectado el Receptor de Satélite o la Videgrabadora presionando  en el control remoto.

### Utilizando su Televisor con estas conexiones

Esta conexión le permite hacer lo siguiente:

- Programar su control remoto Sony para operar su Videgrabadora o Receptor de Satélite (ver página 7).
- Para que el Receptor de Satélite trabaje con esta conexión su Videgrabadora debe estar prendida.
- Para operar su Videgrabadora con el control remoto presiona  o  botón para operar su Receptor de Satélite, ver página 8, sobre como operar otras funciones dependiendo del equipo que quiere usar.
- Presione  varias veces para cambiar la toma de la Videgrabadora (VIDEO input), VHF/UHF (canales locales o canales codificados) o su Decodificador (sistema de cable o canales codificados).

## Conexión de un Reproductor de DVD

Use cables de audio/video (no incluidos) para conectar las tomas de AUDIO/VIDEO OUT del reproductor de DVD a la toma VIDEO IN del Televisor.

### Parte posterior del Reproductor de DVD

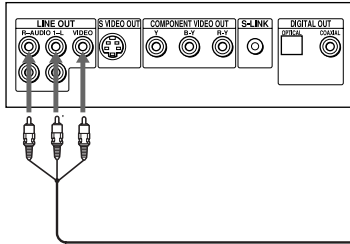

### Parte posterior del Televisor

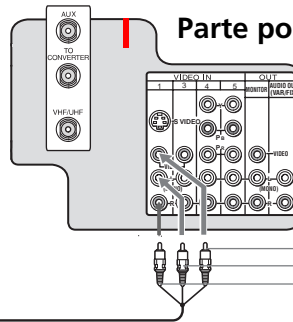

Video (amarillo)  
Audio izquierdo (blanco)  
Audio derecho (rojo)

### Conexión opcional

- ❑ Para obtener una mejor calidad de imagen, utilice S VIDEO en lugar del cable amarillo de video. Como S VIDEO no proporciona sonido, debe mantener conectados los cables de audio.
- ❑ Si el Reproductor de DVD tiene salidas de video para componentes (Y, P<sub>B</sub>, P<sub>R</sub>), puede optimizar la calidad de imagen con cables de video para componentes (480i únicamente).

### Parte posterior del Reproductor de DVD

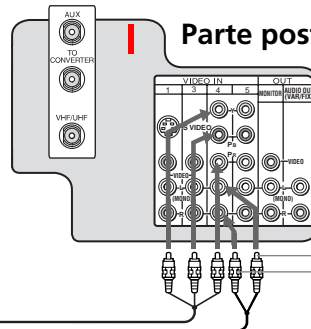
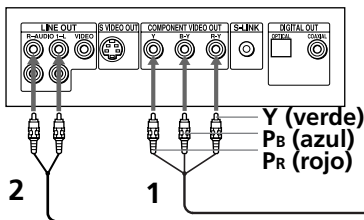

Audio izquierdo (blanco)  
Audio derecho (rojo)

- 1 Conecte Y, P<sub>B</sub>, P<sub>R</sub> OUT de su reproductor de DVD a Y, P<sub>B</sub>, P<sub>R</sub> IN del Televisor con cables de componentes de video (no incluidos).
- 2 Conecte la toma AUDIO OUT del reproductor de DVD a la toma AUDIO IN del Televisor.

Las salidas Y, P<sub>B</sub>, P<sub>R</sub> del reproductor de DVD en ocasiones están marcadas Y, C<sub>B</sub> y C<sub>R</sub> o Y, B-Y, y R-Y. En tal caso, conecte los cables según el color de las tomas.

### Utilizando su Televisor con estas conexiones

Esta conexión le permite hacer lo siguiente:

- ❑ Programar su control remoto Sony para operar su Reproductor de DVD ver página 5.
- ❑ Para activar su control remoto presiona para operar su DVD, ver página 7, sobre como operar otras funciones.
- ❑ Presione varias veces para cambiar la toma del DVD (VIDEO input).

## Conexión de una Cámara de Video

Para conectar su Videocámara usted puede usar la toma del panel frontal del Televisor o la toma del panel posterior del Televisor Audio/ Video. Usando los cables de AUDIO/ VIDEO OUT (no suministrado), conecte el AUDIO/VIDEO OUT de su videocámara a la toma de AUDIO/VIDEO OUT en su TV.

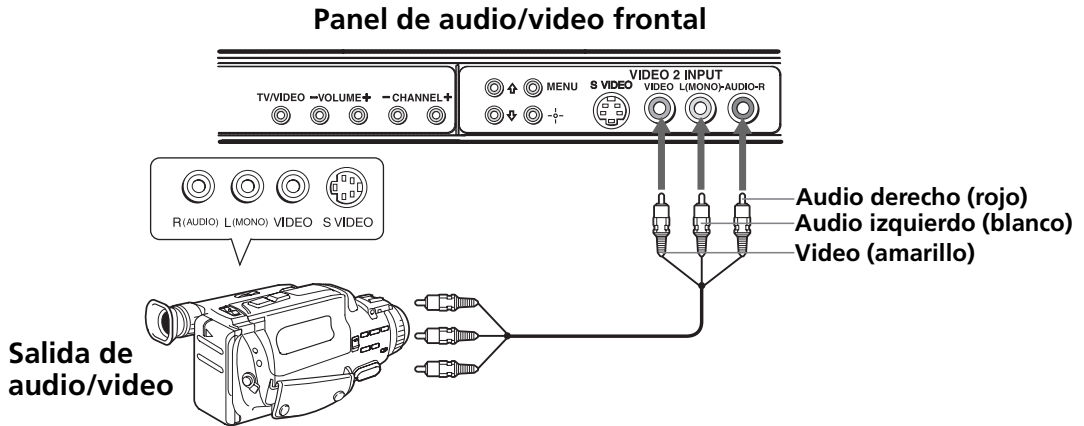

### Conexión opcional

- Para obtener una mejor calidad de imagen, use S VIDEO en lugar del cable amarillo de video. Como S VIDEO no proporciona sonido, debe mantener conectados los cables de audio.

## Conexión de un sistema de Audio

- 1 Usando los cables de audio/video (no suministrados), conecte AUDIO OUT en su TV a una de las tomas no usadas (e.g. TV, AUX, TAPE2) en su estereo
- 2 La utilización del Menú de Audio en la página 31, programa la opción de apagado de las bocinas
- 3 En la página 32, "Audio Out" (salida de audio) de la opción del Menú de Audio selecciona "Variable" si usted quiere controlar el volumen a través del Televisor o "Fijarlo" si usted quiere controlar el volumen a través del sistema de Audio.

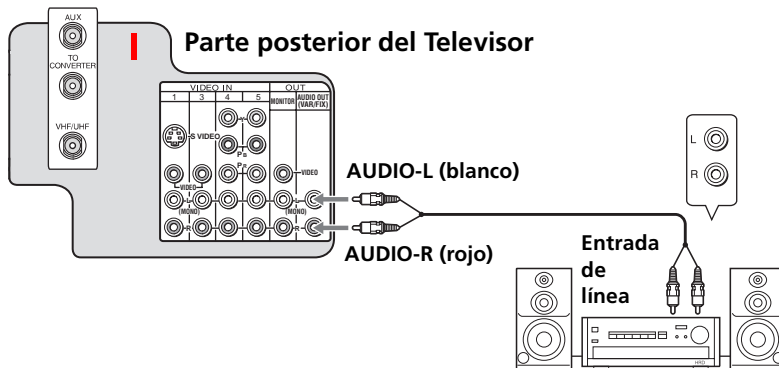

## Conexión de dos Videograbadoras para grabar cintas

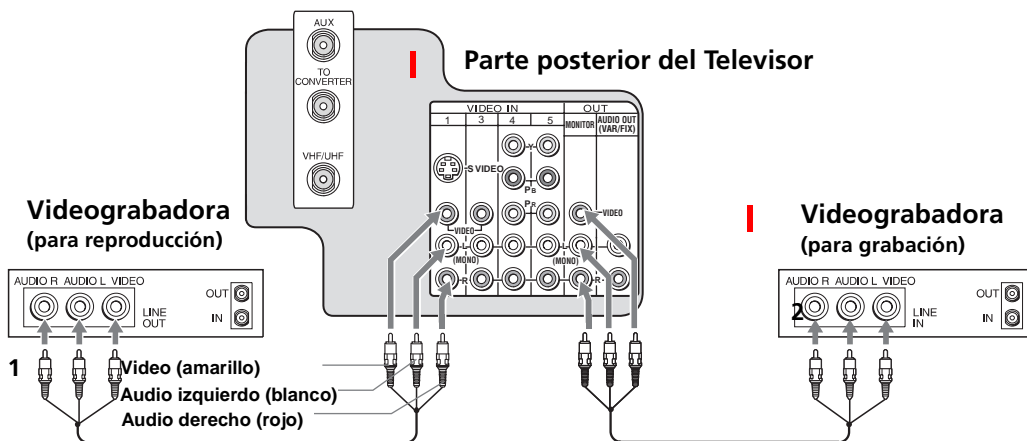

Puede conectar dos Videograbadora para editar cintas de video. También puede conectarlas a su Televisor para ver el programa que esté grabando.



- 1 Use cables de audio/video (no incluidos) para conectar las tomas de AUDIO/VIDEO OUT de la primera Videograbadora a las de AUDIO/VIDEO IN del Televisor.
- 2 Use cables de audio/video (no incluidos) para conectar las tomas de AUDIO/VIDEO IN de la segunda Videograbadora a las de MONITOR AUDIO/VIDEO OUT del Televisor.

### Utilizando su Televisor con estas conexiones

Estas conexiones le permiten hacer lo siguiente:

- Programar su control remoto Sony para operar sus Videograbadoras (ver página 5).
- Para activar su control remoto presiona  para operar su Videograbadora, (ver página 7), sobre operar otras funciones.
- Presione  varias veces para cambiar la toma del DVD (entrada de VIDEO).



# Funciones Básicas del Televisor

## Programación automática del Televisor

Cuando haya terminado de conectar el Televisor, puede ajustar los canales con la opción de Autoprogramación.

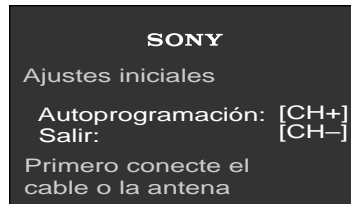









- 1 Primero conecte la antena, después presione  para encender el Televisor. Aparece la pantalla de Ajustes iniciales.





- 2 Presione  en el control remoto o en el panel frontal del Televisor para realizar la Autoprogramación, o presione  para salir.

 La pantalla Ajustes iniciales aparecerá cada vez que encienda el Televisor hasta que active Autoprogramación o se salga de esta página.

### Para volver activar Autoprogramación

- 1 Presione .
- 2 Presione  para seleccionar Canal.
- 3 Presione  para seleccionar Cable. Presione  para seleccionar.
- 4 Presione  o  para seleccionar Si o No según el estado del Televisor. Presione .
- 5 Presione  para seleccionar Autoprogramación. Presione  para buscar los canales.
- 6 Una vez finalizada la función de Autoprogramación, presione  para salir.

### Para reestablecer los ajustes de fábrica del Televisor

- 1 Encienda el Televisor.
- 2 Mantenga oprimido el botón  del control remoto.
- 3 Oprima y suelte el botón POWER (encendido/apagado) del panel frontal del Televisor. (El Televisor se apaga.)
- 4 Suelte el botón .

## Acceso rápido a los menús

Los ajustes siguientes están disponibles en los menús de pantalla. Para obtener más detalles sobre el uso de los menús, consulte “Uso de los Menús” en la página 29.

Menú	Permite
 <p>Video Audio Canal Bloqueo Timer Ajustes Básico</p> <p>Modo : Vívido          Contraste          Brillo          Color          Tinte          Nitidez          Temp. Color: Frío          ClearEdge VM: Alto          DynaBlack: Alto</p> <p>Mover: [Up][Down][Left][Right] Seleccionar: [Enter] Salir: [MENU]</p>	Modificar los ajustes de la imagen.
 <p>Video Audio Canal Bloqueo Timer Ajustes Básico</p> <p>Agudos          Graves          Balance          Auto Volumen: Sí          Efecto: WOW          MTS: Estéreo          Bocinas: Sí          Salida de Audio: Var.</p> <p>Mover: [Up][Down][Left][Right] Seleccionar: [Enter] Salir: [MENU]</p>	Cambiar el ajuste de audio.
 <p>Video Audio Canal Bloqueo Timer Ajustes Básico</p> <p>Canales Favoritos          Cable : No          Fijar Canal: No          Autoprogramación          Omitir/Añadir Canal          Nombre del Canal</p> <p>Mover: [Up][Down][Left][Right] Seleccionar: [Enter] Salir: [MENU]</p>	Personalizar el ajuste de los canales.
 <p>Video Audio Canal Bloqueo Timer Ajustes Básico</p> <p>Bloqueo de Canal          1: No          2: No          3: No          4: No</p> <p>Mover: [Up][Down][Left][Right] Seleccionar: [Enter] Salir: [MENU]</p>	Bloquear los canales no deseados.



Menú

Permite



Ajustar el reloj del Televisor y programar el encendido y apagado automático en un canal establecido mediante Timer 1 y Timer 2 (Reloj 1 y Reloj 2).



Seleccionar los modos de subtítulos, etiquetar las entradas de video, corregir la inclinación de la imagen, seleccionar el idioma de los menús, realzar la resolución de la imagen para el reproductor de DVD o ejecutar una demostración de los menús.



Obtener acceso rápido a los ajustes de menú de uso más común.

## Uso de Imagen dentro de una Imagen (PIP)

La función de Imagen dentro de una Imagen (PIP) le permite ver dos canales al mismo tiempo, uno en tamaño completo en la pantalla del Televisor, y otro en una ventanilla dentro de la pantalla del Televisor.

### Para ver una Imagen dentro de una Imagen

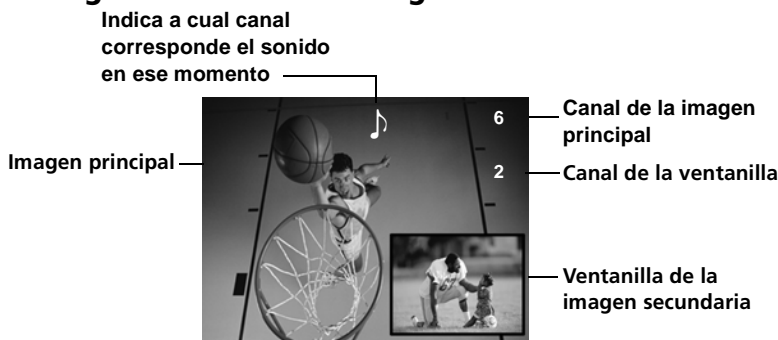

### Para usar Imagen dentro de una Imagen (PIP)

- 1 Presione el botón TV de la barra de FUNCTION (función) del control remoto, para utilizar Imagen dentro de una Imagen (PIP) con los botones amarillos. Sintonice su Televisor en un canal que se esté transmitiendo.
- 2 Presione el botón y aparecerá la ventanilla.
- 3 Use los botones PIP (amarillos) CH (canal) +/- para cambiar el canal de la ventanilla.

### Para verificar Imagen dentro de una Imagen (PIP)









- 1 Presione el botón TV de la barra de FUNCTION (función) del control remoto, para utilizar Imagen dentro de una Imagen (PIP) con los botones amarillos. Sintonice su Televisor en un canal que se esté transmitiendo.
- 2 Presione el botón para activar Imagen dentro de una Imagen (PIP). Presione el botón para intercambiar la imagen principal con la de la ventanilla.
- 3 Seleccione el mismo canal que el de la ventana principal (utilice los botones principales CH (canal) +/- de la parte inferior de su control remoto). Usted debe tener ahora el mismo programa en la pantalla principal y en la ventanilla.
- 4 Utilice los botones amarillos CH (canal) +/- de la función Imagen dentro de una Imagen (PIP), para cambiar el canal de la ventanilla.
- 5 Presione el botón amarillo de Imagen dentro de una Imagen (PIP), para cambiar a otras entradas de video de otros aparatos que estén conectados a cualquiera de las tomas VIDEO IN (entrada de video) de la parte posterior y frontal de su Televisor.

- 6** Si la función Imagen dentro de una Imagen (PIP) no funciona correctamente con el Televisor o el equipo de video conectado a él, consulte la sección de Solución de problemas que comienza en la página 39 para ver posibles soluciones.

 Si tiene problemas con la función Imagen dentro de una Imagen (PIP), consulte la sección "Ajustes que pueden afectar el uso de Imagen dentro de una Imagen (PIP)" (página 28) o consulte la sección de Solución de problemas (página 39) para ver posibles soluciones.

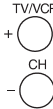
## Función de los botones PIP

### Botones de etiqueta amarilla PIP Descripción

	<p>Presione para activar la función Imagen dentro de una Imagen (PIP). Presione repetidas veces para cambiar el tamaño de la imagen de la ventanilla y desactivar la función Imagen dentro de una Imagen (PIP).</p>
	<p>Presione para recorrer el equipo de video que tiene conectado al Televisor (en la ventanilla). Equipo conectado en VIDEO 4-5 (Y, Pb, Pr) no se podrá ver en PIP.</p>
	<p>Presione para alternar entre el sonido de la imagen principal y el de la ventanilla. El símbolo de sonido  aparece durante tres segundos, indicándole si el sonido que escucha proviene de la imagen principal o de la ventanilla.</p>
	<p>Presione para cambiar el canal de la ventanilla. Para cambiar el canal de la imagen principal, use los botones principales CH (canal) +/- en la parte inferior del control remoto.</p>
	<p>Presione para cambiar la ubicación de la ventanilla a cualquiera de las cuatro esquinas de la pantalla.</p>
	<p>Presione para congelar la imagen de la ventanilla. Presione el botón de nuevo para restaurar la imagen. La imagen principal sigue funcionando normalmente.</p>
	<p>Presione para intercambiar la imagen principal con la de la ventanilla. Presione este botón de nuevo para regresar al estado original.</p>

 Para obtener más información sobre su control remoto, consulte "Uso del Control Remoto y Funciones" en la página 3.

### Para cambiar de canal en la ventanilla

- Utilice los botones amarillos CH (canal) +/- de Imagen dentro de una Imagen (PIP), para navegar a través de los canales del Televisor.
- Utilice el botón amarillo TV/VIDEO para cambiar a otras entradas de video de otros aparatos que estén conectados a su Televisor como su Videograbadora, Reproductor de DVD o Receptor de satélite.









## Conexiones que pueden afectar el uso de Imagen dentro de una Imagen (PIP)



- ❑ No podrá verse en la ventanilla PIP ningún equipo de video que tenga usted conectado a la entrada AUX (auxiliar).
- ❑ PIP no funcionará si está usted viendo todos los canales a través de un Decodificador. Este dispositivo decodifica una sola señal a la vez, por lo que la imagen en la ventanilla será idéntica a la de la imagen principal.
- ❑ Se puede usar Imagen dentro de una Imagen (PIP) para ver en su Televisor imágenes provenientes de diversas fuentes. Por ejemplo, mediante esta función, se puede ver simultáneamente en la pantalla un canal normal de cable y la imagen generada por una Videgrabadora, un reproductor de DVD o un receptor satelital.
- ❑ No podrá verse en la ventanilla PIP ningún equipo conectado en VIDEO 4-5 (Y, Pb, Pr).

# Uso de los Menús

Esta sección muestra las opciones disponibles para configurar y ajustar el Televisor.

## Para acceder a un Menú

- 1 Presione  para ver el menú en pantalla.
- 2 Utilice los botones  o  para seleccionar el menú deseado y después presione .
- 3 Utilice los botones  o  para seleccionar la opción deseada y después presione .
- 4 Siga las indicaciones que aparecen en pantalla para activar las opciones deseadas. Presione  para terminar el ajuste.
- 5 Presione  para salir del menú.

 Presione  una vez para mostrar el menú en pantalla y presiónelo de nuevo para volver a la vista normal. Si no presiona ningún botón, el menú se cierra automáticamente transcurridos 90 segundos aproximadamente.

## Uso del Menú de Video

Para acceder al Menú de Video, siga los siguientes pasos:



### Para mostrar

MENU



### Para seleccionar





Presione  para resaltar la opción deseada; después presione .



### Modo

*Visualización personalizada de la imagen*

Presione  o  para resaltar una de las siguientes opciones y después presione  para seleccionarla.

**Vívido:** Seleccione este modo para aumentar el contraste y la nitidez de la imagen.

**Estándar:** Seleccione este modo para obtener una imagen estándar.

**Película:** Seleccione este modo para obtener una imagen muy detallada.

**Pro:** Seleccione para una imagen natural con mejor nitidez.





Presione







para acceder directamente a los modos de la imagen (Vívido, Estándar, Película y Pro).



### Controles de imagen

**Contraste:** Presione  para reducir el contraste de la imagen. Presione  para aumentar el contraste de la imagen.

**Brillo:** Presione  para oscurecer la imagen. Presione  para aumentar el brillo de la imagen.



**Color:** Presione  para reducir la intensidad del color. Presione  para aumentar la intensidad del color.

**Tinte:** Presione  para aumentar los tonos rojos. Presione  para aumentar los tonos verdes.

**Nitidez:** Presione  para suavizar la imagen. Presione  para aumentar la nitidez de la imagen.

### Temp. Color

*Ajuste de la tonalidad del blanco*

Presione  o  para resaltar una de las siguientes opciones y después presione  para seleccionarla.



**Frío:** Proporciona a los colores blancos un tono azulado.

**Neutro:** Proporciona a los colores blancos un tono neutro.

**Cálido:** Proporciona a los colores blancos un tono rojizo.



### ClearEdge VM

*Claridad de imagen*

Aumenta la definición de la imagen al proporcionar un contorno limpio y nítido a los objetos. Presione  o  para seleccionar una de las siguientes opciones: **Alto, Bajo, No.**

### DynaBlack

*Contraste dinámico*

Mejora el contraste y hace más nítidos los detalles de las imágenes. Presione  o  para seleccionar una de las siguientes opciones: **Alto, Bajo, No.**

## Uso del Menú de Audio

Para acceder al Menú de Audio, siga los siguientes pasos:

**Para mostrar**



**Para resaltar**

















**Para seleccionar**





Presione  para resaltar la opción deseada; después presione .

Video	Audio	Canal	Bloqueo	Timer	Ajustes	Básico	
Agudos 		Graves 				Ajustar	
Balance 		Auto Volumen: Sí		Efecto: WOW			
MTS: Estéreo		Bocinas: Sí		Salida de Audio: Var.			
Tonos de alta frecuencia							
Mover:    		Seleccionar: 		Salir: 			

<b>Agudos</b>	Presione  para reducir los sonidos agudos. Presione  para aumentar los sonidos agudos.
<b>Graves</b>	Presione  para reducir los sonidos graves. Presione  para aumentar los sonidos graves.
<b>Balance</b>	Presione  para enfatizar el volumen de la bocina izquierda. Presione  para enfatizar el volumen de la bocina derecha.
<b>Auto Volumen</b> <i>Estabiliza el volumen</i>	Presione  o  para resaltar una de las siguientes opciones y después presione  para seleccionarla. <b>Sí:</b> Seleccione esta opción para estabilizar el volumen cuando cambie de canal. <b>No:</b> Seleccione esta opción para desactivar Auto Volumen.
<b>Efecto</b>	Presione  o  para resaltar una de las siguientes opciones y después presione  para seleccionarla. <b>Simulado:</b> Simula el sonido estéreo de las salas de cine y teatro en los programas mono. <b>WOW:</b> Provee una espectacular presencia del sonido de los graves. Al activar WOW, BBE se activa directamente para mejorar aún más el programa de audio. <b>TruSurround:</b> Produce un sonido tridimensional dinámico en las señales de audio estéreo. <b>No:</b> Recepción mono o estéreo normal.

 Presione  para acceder directamente a los ajustes de Efecto de Audio (Simulado, WOW, Trusurround, No).

---



**Bocinas** Presione  o  para resaltar una de las siguientes opciones y después presione  para seleccionarla.

*Selección personalizada de la fuente de salida de audio*

**Sí:** Seleccione esta opción para escuchar el sonido de las bocinas del Televisor con sistema de audio externo o sin él.

**No:** Seleccione esta opción para apagar las bocinas del Televisor y escuchar el sonido del Televisor únicamente por las bocinas del sistema de audio externo.

---

**Salida de Audio** Presione  o  para resaltar una de las siguientes opciones y después presione  para seleccionarla.

*Utilícelo para controlar el volumen del Televisor con un equipo de sonido*

**Variable:** Ajusta el volumen a través del Televisor.

**Fija:** Ajusta el volumen a través de un dispositivo estéreo conectado.

---

 La función Salida de Audio sólo puede activarse cuando Bocinas se encuentra en la posición No.

---



## Uso del Menú de Canal

Para acceder al Menú de Canal, siga los siguientes pasos:

**Para mostrar**



**Para resaltar**



**Para seleccionar**



Presione  para resaltar la opción deseada; después presione .

Video	Audio	Canal	Bloqueo	Timer	Ajustes	Básico		
<table border="1" style="width: 100%; border-collapse: collapse;"> <tr> <td style="width: 80%;">                 Canales Favoritos                  Cable : No                  Fijar Canal: No                  Autoprogramación                  Omitir/Añadir Canal                  Nombre del Canal                  Programar sus canales preferidos             </td> <td style="width: 20%; text-align: center; vertical-align: top;">                 Programar             </td> </tr> </table>						Canales Favoritos Cable : No Fijar Canal: No Autoprogramación Omitir/Añadir Canal Nombre del Canal Programar sus canales preferidos	Programar	
Canales Favoritos Cable : No Fijar Canal: No Autoprogramación Omitir/Añadir Canal Nombre del Canal Programar sus canales preferidos	Programar							
Mover:						Seleccionar:	Salir:	

- Canales Favoritos**  
*Acceso rápido a los canales favoritos*
- 1 Presione o para seleccionar la posición (1 a 8) en la que desea ajustar un canal favorito y después presione .
  - 2 Presione o para desplazarse por los canales hasta encontrar el que desea agregar a sus canales favoritos.
  - 3 Presione para seleccionarlo, esto cambiará su Televisor de manera automática al canal que seleccionó.
  - 4 Presione para volver al menú de Canal o presione para salir.

Para usar la opción de Canales Favoritos: Salga de todos los menús y presione . Presione o para desplazar el cursor al número de canal deseado y presione .

- Cable**
- Presione o para resaltar una de las siguientes opciones y después presione para seleccionarla.
- Sí:** Selecciónelo si recibe canales de sistema de televisión de pago.
- No:** Selecciónelo si utiliza una antena de televisión.

Después de cambiar los ajustes del cable, deberá realizar la función Autoprogramación.

- Fijar Canal**
- Presione o para resaltar una de las siguientes opciones y después presione para seleccionarla.
- No:** Fijar Canal no está activado.
- 2-6:** Selecciónelos cuando desee controlar toda la selección de canales por medio de un Decodificador o una Videgrabadora. Seleccione el canal adecuado (normalmente el 3 o el 4) y utilice el control remoto del Decodificador o de la Videgrabadora para seleccionar los canales.
- AUX 2-6:** Utilice este ajuste en lugar de **2-6** si desea cambiar de canal mediante un Decodificador, Videgrabadora o Receptor de Satélite y lo haya conectado a la entrada AUX.
- Video 1:** Seleccione esta opción para fijar su Televisor a las entradas de video disponibles cuando tenga conectado el equipo de video, (por ejemplo, el Receptor de Satélite).

**Autoprogramación** Realice la función de Autoprogramación siempre que cambie la entrada de VHF/UHF en la parte posterior del Televisor.  
El Televisor recorrerá todos los canales disponibles y programará los que se reciben.

**Omitir/Añadir Canal** Utilice esta función después de ejecutar Autoprogramación para omitir los canales no deseados o para añadir nuevos canales.

- 1 Presione  $\uparrow$  o  $\downarrow$  para seleccionar la posición del canal deseado y después presione  $\oplus$ .
- 2 Presione  $\uparrow$  o  $\downarrow$  para omitir o añadir canal y después presione  $\oplus$ .
- 3 Presione  $\leftarrow$  para volver al menú de Canal o presione  $\text{MENU}$  para salir.

 Cuando presione CH+ o CH- no tendrá acceso a los canales omitidos, sólo a través de los botones  $\text{0}$ - $\text{9}$  podrá sintonizarlos.

**Nombre del Canal** 1 Presione  $\oplus$  y después presione  $\uparrow$  o  $\downarrow$  hasta que localice el número de canal deseado. Presione  $\oplus$  para activar el canal.

- 2 Presione  $\downarrow$  para resaltar "Nombre" y después presione  $\oplus$ . Presione  $\uparrow$  o  $\downarrow$  para mostrar la primera letra o número de la etiqueta y después presione  $\oplus$  para seleccionarlo. Repita este proceso, hasta que halla seleccionado todas las letras.

- 3 Presione  $\leftarrow$  para volver al Menú de Canal o presione  $\text{MENU}$  para salir.

 No podrá utilizar las opciones Canales Favoritos, Cable, Omitir/Añadir Canal, Nombre del Canal y el menú de Bloqueo de Canal cuando Fijar Canal esté activado.

## Uso del Menú de Bloqueo de Canal

Para acceder al Menú de Bloqueo de Canal, siga los siguientes pasos:

**Para mostrar**



**Para resaltar**



**Para seleccionar**





- Bloquear o Desbloquear**
- 1 Presione  $\uparrow$  o  $\downarrow$  para seleccionar la posición (1 a 4) en la que desee bloquear o desbloquear un canal y después presione  $\rightarrow$ .
  - 2 Presione  $\uparrow$  o  $\downarrow$  para desplazarse por los canales hasta encontrar el canal que desee bloquear o desbloquear y después presione  $\rightarrow$ .
  - 3 Presione  $\text{MENU}$  para salir.

 Si un canal está bloqueado, se mostrará una pantalla negra con la palabra "Bloqueado", (solamente para el uso habitual del Televisor).





## Uso del Menú de Timer (Reloj)

Para acceder al Menú de Timer, siga los siguientes pasos:

Para mostrar      Para resaltar      Para seleccionar











**Hora Actual** Permite ajustar el día y la hora actual en su Televisor. Presione  para abrir el menú de Hora Actual:

- 1 Presione  o  para resaltar el día que desee introducir y después presione , repita este proceso hasta que halla seleccionado la hora completa.
- 2 Presione  para salir del menú.

 Debe ajustar la Hora Actual antes de poder utilizar Timer 1 y Timer 2 (Reloj 1 y Reloj 2).

**Timer 1 y Timer 2 (Reloj 1 y Reloj 2)** Programa su Televisor para encenderse y apagarse al día, hora, duración y canal deseado. La duración máxima del reloj es de 6 horas. Cuando el canal esté fijado, no será necesario introducir el canal.

*Visualización programada*

- 1 Presione  o  para seleccionar Timer 1 o Timer 2 (Reloj 1 o Reloj 2) y después presione .
- 2 Presione  o  para introducir el día, hora, duración y el canal deseado y después presione . Timer (Reloj) debe estar en Sí cuando se haya fijado, y se encenderá una luz roja en el panel frontal del Televisor.
- 3 Presione  para salir del menú.

 Seleccione No para desactivar el Timer (Reloj). El ajuste anterior quedará grabado.

 Al ejecutar Autoprogramación, los ajustes de Timer 1 y Timer 2 (Reloj 1 y Reloj 2) se borrarán. Asimismo, en caso de producirse una pérdida de electricidad, los ajustes de Hora Actual, Timer 1 y Timer 2 (Reloj 1 y Reloj 2) se borrarán.

## Uso del Menú de Ajustes

Para acceder al Menú de Ajustes, siga los siguientes pasos:

**Para mostrar**





**Para resaltar**



**Para seleccionar**





Presione  para resaltar la opción deseada; después presione .



### **Caption Vision**

*Subtítulos*

Permite seleccionar tres modos de subtítulos (para programas que se emiten con subtítulos).

Presione  o  para resaltar una de las siguientes opciones y después presione .

**No:** Los subtítulos no están activados.

**CC1, 2, 3, 4:** Muestra el diálogo impreso y los efectos de sonido de un programa.



**Text1, 2, 3, 4:** Muestra información sobre la red o emisora.



**Info:** Muestra el nombre del programa actual y el tiempo restante, (si esta disponible) cuando se cambia de canal o presioná el botón de DISPLAY.



### **Etiqueta de Video**

*Etiqueta el equipo conectado*

Permite etiquetar los componentes de audio/video que tiene conectado a su Televisor: Videograbadora, Reproductor de DVD, etc. Cuando presione TV/VIDEO para cambiar las entradas de video, la etiqueta de video se mostrará en la pantalla.



**1** Presione  o  para seleccionar la entrada que desee etiquetar y después presione .

**2** Presione  o  para elegir una etiqueta y presione .

**3** Presione  para volver al Menú de Ajustes o presione  para salir.



 Si usted selecciona "Omitir", su Televisor pasará por alto esta conexión al oprimirse el botón TV/VIDEO.

### **Rotación**

Presione  o  para corregir la inclinación de la imagen entre -5 a +5 grados presione .

### **Idioma**

Muestra todos los menús en el idioma elegido.

Presione  o  para seleccionar el idioma deseado: English (Inglés), Español, Français (Francés) y después presione .

### **Modo 16:9**

Proporciona una resolución mejorada de la imagen para fuentes de pantalla panorámica como el Reproductor de DVD (sólo está disponible cuando el Televisor esté en modo Video).

### **Demo**

*Demostración*

Presione  para efectuar una demostración de los Menús en pantalla.

 Puede presionar cualquier tecla para salir del modo Demo (Demostración).

## Uso del Menú Básico

Para acceder al Menú Básico, siga los siguientes pasos:

**Para mostrar** **Para resaltar**  **Para seleccionar**



Presione  para resaltar la opción deseada; después presione .





Mover:     Seleccionar:  Salir: 

**Contraste** Presione  para disminuir el contraste de la imagen.

*Contraste de la imagen* Presione  para aumentar el contraste de la imagen.

**Caption Vision** En el menú Básico, Caption Vision solo muestra No y la última opción seleccionada (CC1-4, Text1-4, o Info).

*Subtítulos*

**Efecto** Presione  o  para resaltar una de las siguientes opciones y después presione  para seleccionarla.





**Simulado:** Simula el sonido estéreo de las salas de cine y teatro en los programas mono.

**WOW:** Provee una espectacular presencia del sonido de los graves. Al activar WOW, BBE se activa directamente para mejorar aún más el programa de audio.

**TruSurround:** Produce un sonido tridimensional dinámico en las señales de audio estéreo.

**No:** Recepción mono o estéreo normal.

**Menú Avanzado** Presione  para volver a los menús avanzados.



 Si utiliza el botón  para cerrar el menú Básico, éste aparecerá de nuevo cuando vuelva a presionar . Para acceder a los demás menús, presione  para resaltar el Menú Avanzado y después presione .

# Información Adicional



## Solución de problemas

Si tiene problemas con el Televisor, intente seguir las indicaciones que se sugieren a continuación. Si el problema persiste, consulte con su proveedor Sony más cercano.

### General

Problema	Posibles Soluciones
<b>Hace falta restablecer los ajustes de fábrica</b>	<input type="checkbox"/> Encienda el Televisor, mientras mantenga oprimido el botón  del control remoto, oprima el botón de POWER (encendido/apagado) del panel frontal del Televisor (el Televisor se apagará). Suelte el botón  . Encienda el Televisor.
<b>El Televisor está sucio</b>	<input type="checkbox"/> Limpié el Televisor con un paño suave y seco. Nunca use solventes fuertes como diluyentes o bencina, puesto que pueden dañar el acabado de la unidad.
<b>Aparece un cuadro negro en la pantalla</b>	<input type="checkbox"/> Esta seleccionada una opción de texto en el menú de Ajustes (página 37) y no hay texto disponible. Para desactivar esta función, seleccione No en la opción Caption Visión (subtítulos). Si desea ver subtítulos, escoja CC1-4 en lugar de Text1-4.

### Control Remoto

<b>El Control Remoto no funciona</b>	<input type="checkbox"/> Al operar su Televisor oprima TV (FUNCTION). <input type="checkbox"/> Vea si instaló las baterías correctamente. <input type="checkbox"/> Las baterías pueden estar bajas. Sustitúyalas (página 2). <input type="checkbox"/> Aleje el Televisor por lo menos 1 metro de cualquier lámpara fluorescente.
<b>No se puede cambiar el canal con el control remoto</b>	<input type="checkbox"/> Asegúrese de que no ha cambiado el Televisor del canal 3 o 4 con otro dispositivo para cambiar canales. <input type="checkbox"/> Si esta usando otro aparato para cambiar los canales, no olvide presionar el botón FUNCTION correspondiente a ese aparato. Por ejemplo, si esta usando su Videograbadora para controlar los canales, asegúrese de presionar los botones VCR/DVD FUNCTION (página 4).
<b>No puede acceder a otros menús con el menú Básico.</b>	<input type="checkbox"/> Si utiliza el botón  para cerrar el menú básico, este aparecerá de nuevo cuando vuelva a presionar  . Para acceder a los demás menús, seleccione menú avanzado (página 38).
<b>Perdió el control remoto</b>	<input type="checkbox"/> Puede utilizar los botones del panel frontal de audio y video para acceder a los menús (página 2). Póngase en contacto con su proveedor Sony más cercano para solicitar uno de repuesto.
<b>Más de un código esta en listado</b>	<input type="checkbox"/> Introdúzcalos por separados hasta que encuentre el código correcto para su equipo.
<b>Se desprogramó el control remoto cuando cambio las baterías</b>	<input type="checkbox"/> Debe programar de nuevo el control remoto.

## Video

<b>No hay imagen ni sonido</b>	<ul style="list-style-type: none"> <li><input type="checkbox"/> Asegúrese de que el cable de alimentación esta conectado.</li> <li><input type="checkbox"/> Si hay luz roja que parpadea en la parte frontal del Televisor durante unos minutos, desconecte y vuelva a conectar el cable de alimentación para restaurar el Televisor. Si el problema persiste llame al servicio técnico local.</li> <li><input type="checkbox"/> Compruebe los ajuste de TV/VIDEO; si ve si se ven en el Televisor, póngalo en TV; si ve imágenes de un aparato de video, póngalo en VIDEO 1,2,3 o 4 (página 4).</li> <li><input type="checkbox"/> Intente ver otro canal para descartar algún problema en la emisora.</li> </ul>
<b>Imagen de mala calidad, sin Imagen, buen sonido</b>	<ul style="list-style-type: none"> <li><input type="checkbox"/> Ajuste el contraste en el menú de Video (página 30).</li> <li><input type="checkbox"/> Ajuste el brillo en el menú de Video (página 30).</li> <li><input type="checkbox"/> Compruebe las conexiones de la antena o del cable (página 11).</li> </ul>
<b>Sin color</b>	<ul style="list-style-type: none"> <li><input type="checkbox"/> Ajuste Color en el menú de Video (página 30).</li> </ul>
<b>Sin señal</b>	<ul style="list-style-type: none"> <li><input type="checkbox"/> Compruebe el ajuste del cable en el menú de Canal (página 33).</li> <li><input type="checkbox"/> Compruebe las conexiones de la antena o del cable (página 33).</li> <li><input type="checkbox"/> Asegúrese de que el canal seleccionado este emitiendo señal.</li> </ul>
<b>Líneas de puntos o rayas</b>	<ul style="list-style-type: none"> <li><input type="checkbox"/> Ajuste la antena.</li> <li><input type="checkbox"/> Aparte el Televisor de cualquier otro equipo electrónico. Algunos equipos electrónicos crean ruido eléctrico que puede interferir con la recepción del Televisor.</li> </ul>
<b>Imágenes dobles o fantasmas</b>	<ul style="list-style-type: none"> <li><input type="checkbox"/> Revise la antena exterior a llame al servicio técnico de Televisión por pago.</li> </ul>

## Audio

<b>Buena imagen, sin sonido</b>	<ul style="list-style-type: none"> <li><input type="checkbox"/> Presione  para que desaparezca Muting de la pantalla (página 3).</li> <li><input type="checkbox"/> Compruebe los ajustes de Audio. Es posible que el Televisor este ajustado en Auto SAP o Bocinas se encuentre en la posición No (página 31).</li> </ul>
---------------------------------	--

## Canales

<b>No se reciben canales con un número alto (UHF) cuando se utiliza una antena</b>	<ul style="list-style-type: none"> <li><input type="checkbox"/> Asegúrese de que el cable esta en la posición NO en el menú de canal (página 33).</li> <li><input type="checkbox"/> Ejecute auto programación para añadir canales que actualmente no estén en la memoria (página 34).</li> </ul>
<b>Parece que no funcionan las emisoras de cable</b>	<ul style="list-style-type: none"> <li><input type="checkbox"/> Asegúrese de que el cable este en la posición Si en el menú de Canal (página 33).</li> <li><input type="checkbox"/> Ejecute Auto programación para añadir canales que actualmente no estén en la memoria (página 34).</li> </ul>
<b>Sólo puedo sintonizar señal de televisión en la ventanilla</b>	<ul style="list-style-type: none"> <li><input type="checkbox"/> Asegúrese de que no configuro la etiqueta de video en el menú de ajustes (página 37) para omitir sus entradas de video.</li> </ul>



## Imagen en Imagen (PIP)

<b>El control remoto no funciona en modo PIP</b>	<input type="checkbox"/> Presione el botón TV FUNCTION. Es posible que accidentalmente haya presionado el botón VCR/DVD FUNCTION, que cambia los botones PIP al modo de Videgrabadora (página 26).
<b>No aparece la ventanilla en pantalla o no tiene imagen</b>	<input type="checkbox"/> Asegúrese que la ventanilla se encuentre sintonizada con una fuente de video o un canal con programación al aire. <input type="checkbox"/> Es posible que se encuentre sintonizado con una entrada de video que no tiene nada conectado. Trate de recorrer sus entradas de video con el botón amarillo con el punto rojo PIP TV/VIDEO (página 26).
<b>Se ve el mismo programa en la ventanilla que en la pantalla principal</b>	<input type="checkbox"/> Es posible que ambas se encuentren sintonizadas al mismo canal. Trate de cambiar canales, ya sea en la pantalla principal o en la ventanilla (página 26). <input type="checkbox"/> Es posible que su Televisor este configurado para seleccionar todos los canales mediante un Decodificador de cable. El Decodificador de cable solo decodificara una señal a la vez, por lo que usted no podrá utilizar la función PIP. Si es posible, conecte un cable directo a la toma VHF/UHF de su Televisor. Esto solo funcionara si su sistema de cable proporciona una señal no codificada (página 13).
<b>No se ve VIDEO 4-5 (Y, PB, PR) en PIP (Imagen en Imagen)</b>	<input type="checkbox"/> El equipo conectado en VIDEO 4-5 no se podrá ver en Imagen en Imagen (PIP).

*Si después de leer este manual de instrucciones, tiene más preguntas relacionadas con el uso del Televisor Sony, póngase en contacto con su proveedor Sony más cercano para recibir asistencia técnica.*

## Especificaciones

Sistema de televisión	Estándar de televisión estadounidense /NTSC
Cobertura de canales	VHF: 2-13/UHF: 14-69/CATV: 1-125
Antena	Terminal de antena externa para VHF/UHF de 75 ohm
Tubo de imagen	Cinescopio FD Trinitron®
Requisitos de alimentación para todos los países excepto en donde se indique:	ca 120 V 60 Hz ca 220 V 50/60 Hz (Chile, Perú, Bolivia)
Accesorios incluidos	Baterías (R6) de tamaño AA (2) Control remoto RM-Y181 (1)
Accesorios opcionales	Cables de conexión VMC-810S/820S, VMC-720M, YC-YC-15V/30V, RK74A Mezclador EAC-66 U/V Mesa para Televisor: SU-27F1
<b>KV-29FV310, KV-29FV310C</b>	
Tamaño de la pantalla	Tamaño de pantalla visible: 679 mm (27 pulgadas) medido en diagonal Tamaño de pantalla real: 736,6 mm (29 pulgadas) medido en diagonal
Entradas/salidas	Entradas 1 video, 1 audio (panel frontal) 2 video, 2 audio (panel posterior) 2 S VIDEO (1 en el panel frontal, 1 en el panel posterior) 2 RF 2 Y, PB, PR, 2 audio 1 AUDIO OUT 1 MONITOR OUT
Salida de bocina	7,5 W X 2, 15 W subwoofer
Consumo de energía para todos los países excepto en donde se indique:	215 W 210 W (Chile, Perú, Bolivia) 1 W en espera
Dimensiones (Anch. × Alt. × Prof.):	784 x 601,5 x 520 mm (30 <sup>7</sup> / <sub>8</sub> x 23 <sup>1</sup> / <sub>8</sub> x 20 <sup>1</sup> / <sub>2</sub> pulgadas)
Peso	50,4 kg (111 lbs. 1,7 oz)

*El diseño y las especificaciones están sujetos a cambios sin previo aviso.*

# Índice alfabético

## A

Agudos **31**  
Auto Volumen **31**  
Autoprogramación **23**

## B

Balance **31**  
Bloquear o Desbloquear **35**  
Bocinas **32**  
Brillo **30**

## C

Cable **33**  
Canales Favoritos **33**  
Caption Vision **37**  
Características del Televisor **1**  
ClearEdge VM **30**  
Color **30**  
Conexiones  
    Cable y antena **11**  
    Conexión de dos Videograbadoras **18**  
    Conexión de un reproductor de DVD **19**  
    Conexión de un sistema de sonido **20**  
    Conexión de un Televisor y una Videograbadora **14**  
    Conexión de un Televisor, una Videograbadora y un Decodificador **15**  
    Conexión de un Televisor, Videograbadora y un receptor de Satélite **18**  
    Conexión de una cámara de video **20**  
    Decodificador y cable **13**  
    Televisor y Decodificador **12**  
Contraste **30**  
Control de idioma **37**  
Control remoto  
    Baterías **2**  
    Controles PIP RM-Y181 **26–27**  
    Programación **5**

## D

DISPLAY (Despliegue) **4**

DynaBlack **30**

## E

Efecto  
    No **31**  
    Simulado **31**  
    TruSurround **31**  
    WOW **31**  
Especificaciones **42**

## F

Fijar Canal **33**

## G

Graves **31**

## H

Hora Actual **36**

## J

Joystick **4**

## M

Menú Avanzado **38**  
Menú Configuración **37**  
Menús  
    Ajustes **37**  
    Audio **31**  
    Básico **38**  
    Bloqueo de Canal **35**  
    Canal **33**  
    Configuración **37**  
    Timer (Reloj) **36**  
    Video **30**  
Modo  
    Deportes **30**  
    Estándar **30**  
    Película **30**  
    Vívido **30**

## N

Nitidez **30**  
Nombre del Canal **34**

## O

Omitir/Añadir Canal **34**

- P**
- Panel frontal del Televisor **2**
  - Panel posterior del Televisor **9**
  - PIP
    - Control remoto RM-Y181 **26–27**
- R**
- Reproductor de DVD
    - Resolución de pantalla panorámica **37**
  - Resolución de pantalla panorámica **37**
- S**
- Salida de Audio **32**
- SLEEP** **3**
- Solución de problemas **39**
- Sonido
- Alternar entre la imagen principal y la ventanilla **27**
- Subtítulos **37**
- T**
- Temperatura del Color **30**
  - Tilt Control **37**
  - Timer 1 y Timer 2 (Reloj 1 y Reloj 2) **36**
  - Tinte **30**



# PRINTING THE SERVICE MANUAL

The PDF of this service manual is not designed to be printed from cover to cover. The pages vary in size, and must therefore be printed in sections based on page dimensions.

## NON-SCHEMATIC PAGES

Data that does NOT INCLUDE schematic diagrams are formatted to 8.5 x 11 inches and can be printed on standard letter-size and/or A4-sized paper.

## SCHEMATIC DIAGRAMS

The schematic diagram pages are provided in two ways, full size and tiled. The full-sized schematic diagrams are formatted on paper sizes between 8.5" x 11" and 18" x 30" depending upon each individual diagram size. Those diagrams that are LARGER than 11" x 17" in full-size mode have been tiled for your convenience and can be printed on standard 11" x 17" (tabloid-size) paper, and reassembled.

### TO PRINT FULL SIZE SCHEMATIC DIAGRAMS

---

If you have access to a large paper plotter or printer capable of outputting the full-sized diagrams, output as follows:

- 1) Note the page size(s) of the schematics you want to output as indicated in the middle window at the bottom of the viewing screen.
- 2) Go to the File menu and select Print Set-up. Choose the printer name and driver for your large format printer. Confirm that the printer settings are set to output the indicated page size or larger.
- 3) Close the Print Set Up screen and return to the File menu. Select "Print..." Input the page number of the schematic(s) you want to print in the print range window. Choose OK.

### TO PRINT TILED VERSION OF SCHEMATICS

---

Schematic pages that are larger than 11" x 17" full-size are provided in a 11" x 17" printable tiled format near the end of the document. These can be printed to tabloid-sized paper and assembled to full-size for easy viewing.



If you have access to a printer capable of outputting the tabloid size (11" x 17") paper, then output the tiled version of the diagram as follows:

- 1) Note the page number(s) of the schematics you want to output as indicated in the middle window at the bottom of the viewing screen.
- 2) Go to the File menu and select Print Set-up. Choose the printer name and driver for your printer. Confirm that the plotter settings are set to output 11" x 17", or tabloid size paper in landscape (  ) mode.
- 3) Close the Print Set Up screen and return to the File menu. Select "Print..." Input the page number of the schematic(s) you want to print in the print range window. Choose OK.

### TO PRINT SPECIFIC SECTIONS OF A SCHEMATIC

---

To print just a particular section of a PDF, rather than a full page, access the Graphics Select tool in the Acrobat Reader tool bar.

- 1) To view the Graphics Select Tool, press and HOLD the mouse button over the Text Select Tool which looks like: . This tool will expand to reveal to additional tools. Choose the Graphics Select tool by placing the cursor over the button on of the far right that looks like: 
- 2) After selecting the Graphics Select Tool, place your cursor in the document window and the cursor will change to a plus (+) symbol. Click and drag the cursor over the area you want to print. When you release the mouse button, a marquee (or dotted lined box) will be displayed outlining the area you selected.
- 3) With the marquee in place, go to the file menu and select the "Print..." option. When the print window appears, choose the option under the section called "Print Range" which says "Selected Graphic".

Select OK and the output will print only the area that you outlined with the marquee. 

(continued >)

## ON-SCREEN SEARCH OPTION

All of the text within the service manual PDF is content searchable. This means that you can enter any text, word, phrase or reference number that appears in the manual, and the PDF software will search, find and move the cursor to the location where you requested text first appears. This feature can be particularly useful in locating components on a specific schematic or printed wire circuit board (PWB) diagrams.

Follow these steps to effectively locate a component on a schematic diagram:

- 1) Locate the schematic you want to search by clicking on the corresponding bookmark on the left side of the screen. The view on the right of the screen will then jump to the desired schematic page.
- 2) Magnify the diagram to at least 400% before conducting a component search. This will enable you to easily view the reference number when it is highlighted on screen. To do this, click on the magnifying glass button on the tool bar at the top of the screen. Move the cursor over the diagram and RIGHT click you mouse. Select the 400% magnification option on the pop-up menu. Click on the button with the icon of the open hand to deactivate the magnification tool
- 3) Search the diagram (or the entire manual) by clicking on the binocular button tool at the top of the screen. The "Find" window will appear and allow you to type in your desired text. Type in a reference designator, such as R502, and click on the "Find" button. If the component is not on the diagram, but is listed anywhere else in the manual, the cursor will jump to the first location the text is found in the file. To find another instance of that same text, click on the binocular button again and select "Find Again."