

TOSHIBA

OWNER'S MANUAL

Color Television

COLORSTREAM®

Set up

Preparation

Basic Operation

Advanced Operation

Reference Section

32A41
36A41

Owner's Record

The model number and serial number are on the back of your TV. Record these numbers in the spaces below. Refer to these numbers whenever you communicate with your Toshiba dealer about this TV.

Model number:

Serial number:

Important Information

WARNING

TO REDUCE THE RISK OF FIRE OR ELECTRIC SHOCK, DO NOT EXPOSE THIS APPLIANCE TO RAIN OR MOISTURE.

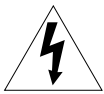
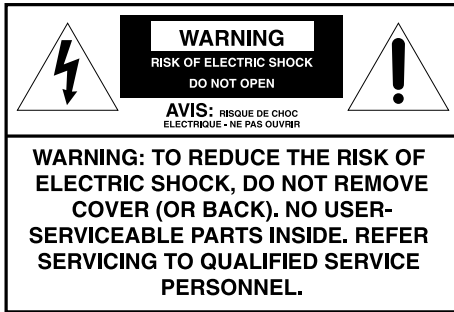

The lightning symbol in the triangle tells you that the voltage inside this product may be strong enough to cause an electric shock. **DO NOT TRY TO SERVICE THIS PRODUCT YOURSELF.**



The exclamation mark in the triangle tells you that important operating and maintenance instructions follow this symbol.

CAUTION

TO PREVENT ELECTRIC SHOCK, DO NOT USE THIS POLARIZED PLUG WITH AN EXTENSION CORD RECEPTACLE OR OTHER OUTLET UNLESS THE PRONGS CAN BE FULLY INSERTED INTO THE OUTLET TO PREVENT ANY EXPOSURE OF THE PRONGS ON THE POLARIZED PLUG.

ATTENTION

POUR PRÉVENIR LES CHOC ÉLECTRIQUES NE PAS UTILISER CETTE FICHE POLARISÉE AVEC UN PROLONGATEUR, UNE PRISE DE COURANT OU UNE AUTRE SORTIE DE COURANT, SAUF SI LES LAMES PEUVENT ÊTRE INSÉRÉS À FOND SANS EN LAISSER AUCUNE PARTIE À DÉCOUVERT.

CAUTION

The plug has one prong wider than the other and will fit only one way into a standard electrical outlet (120 volt AC, 60 Hz). If the plug does not fit into the outlet, try turning it around. If the plug still does not fit, the outlet is probably non-standard and must be replaced by a qualified electrician. Do not tamper with the plug or try to force it into a non-standard outlet.

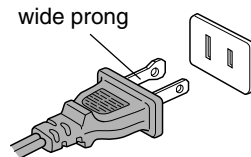

Note to CATV system installers in the USA

This reminder is provided to call the CATV system installer's attention to Article 820-40 of the NEC, which provides guidelines for proper grounding, and, in particular, specifies that the cable ground shall be connected to the grounding system of the building, as close to the point of cable entry as practical.

Precautions

Installing your TV

- Place the TV on the floor or on a sturdy platform. The mounting surface should be flat and steady. If you install the TV on a soft floor, make sure that the floor is not damaged by the weight of the TV.
- This TV set may be used only with Toshiba stand listed on page 32. Use with other stands may result in instability, causing possible injury.
- Place the TV far enough away from the walls to allow proper ventilation. This will prevent the TV from overheating and avoid possible damage to the TV. Avoid dusty areas too.

Using your TV

- Do not stand or climb on the TV.
- Do not put any heavy object on top of the TV.
- Do not place containers with liquids such as drinks, aquariums, or lighted candles on the TV. If any foreign material or water leaks into the TV, unplug the power cord and contact your dealer.
- Avoid displaying stationary images on your TV screen for extended periods of time. Stationary patterns (such as those generated by computer displays, video games, or stock market reports) can become permanently engrained on the picture tube. This damage is not protected by your warranty because it is the result of misuse. If you wish to use your TV to display still images, reduce brightness and contrast settings. Never leave a computer or video game display unattended.

Cleaning your TV

- To clean the TV screen:
 1. Unplug the TV from the power outlet to avoid possible shock hazard.
 2. Use a clean, dry cellulose sponge or chamois cloth to clean TV screen and trim. Do not use liquid or aerosol cleaning agents. Liquid spilling into the TV cabinet may cause electric shock or damage the TV.

CAUTION

Never use strong solvents such as thinner, benzene, or other chemicals on or near the cabinet, as they can damage the finish of the cabinet.

Contents

Set Up

Introduction	4
Exploring your new TV	4
Selecting a location for your TV	4
Connecting your TV	5
Note regarding picture quality when connecting video equipment	5
Connecting a VCR	5
Connecting a cable converter box	5
Connecting a cable converter box and a VCR	6
Connecting a satellite receiver and a VCR	6
Connecting a DVD player with component video and a VCR	7
Connecting two VCRs	7

Preparation

Preparing the remote control for use	8
Installing the remote control batteries	8
Location of controls on TV and remote control	9
Using the remote control with a VCR or cable TV converter	10
Programming the remote control for use with a non-Toshiba VCR or cable TV converter	11
Menu function (general instructions)	14
First-time operation	15
Turning the TV set on	15
Selecting the on-screen display language	15
Understanding the Auto Power Off feature	15
Understanding the Last Mode Memory feature	15
Programming the channel memory	16
TV/CABLE function	16
CH PROGRAM function	16
ADD/ERASE function	17

Basic Operation

Watching TV programs or videotapes	18
Selecting a TV channel	18
Selecting the video input source	18
About the DEMO (Demonstration) mode	18
Convenient remote control functions	19
Displaying on-screen information	19
Muting the sound	19
Changing quickly between two channels	19
Adjusting the picture	20
Adjusting the picture quality	20
Selecting the color temperature	21
Selecting the picture preference function	21
Adjusting the sound	22
Adjusting the sound quality	22
Using the off-timer (sleep timer)	23
Setting the off-timer	23
Canceling the off-timer	23
Selecting stereo/SAP broadcasts	24
Listening to stereo sound	24
Activating the surround sound effect	24
Listening to a second audio program (SAP)	25

Advanced Operation

Using the favorite channel programming feature	26
Programming your favorite channels	26
Selecting your favorite channels	26
Using the closed caption feature	27
Viewing captions or text	27
Using the V-CHIP control feature	28
Opening the V-CHIP CONTROL menu	28
Adjusting the V-CHIP CONTROL menu	29
ENABLE BLOCKING	29
SET RATING	29
MPAA RATINGS	29
TV RATINGS	29
SET BLOCKING OPTIONS	30
NEW PIN CODE	30
Unblocking programs temporarily	31
BLOCK CHANNEL function	31

Reference Section

Specifications	32
Troubleshooting	33
Limited United States warranty	34

Introduction

This owner's manual applies to models 32A41 and 36A41, and there are slight differences between them. Model 32A41 is used in this manual for illustration purposes. Instructions in this manual are based on using the buttons on the remote control. Check the model of your TV before using this manual. Write your model and serial numbers in the spaces provided on the cover for your records.

Exploring your new TV

You can operate your TV using the buttons on the front panel or the remote control.

The back panel provides all the terminal connections you will need to connect other equipment to your TV.

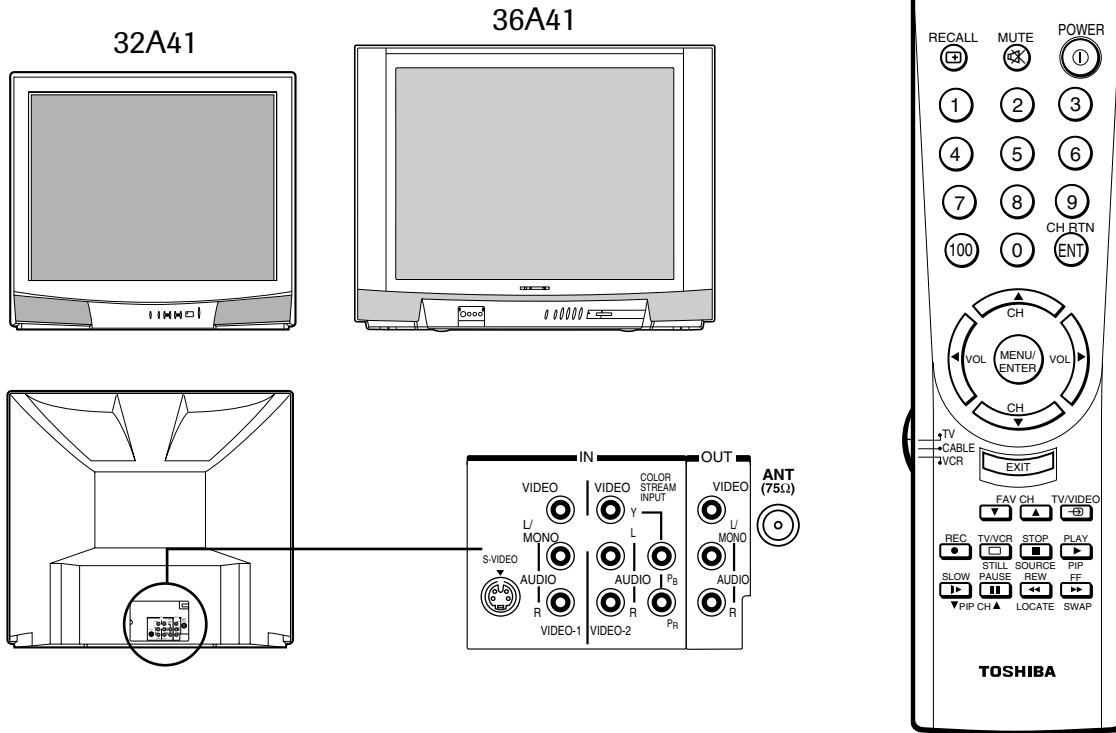

Selecting a location for your TV

- Place the TV either on the floor or on the TV stand listed in the "Notice of Possible TV Stand Instability" at right.
- Place the TV in a location where light does not directly hit the screen.
- Place the TV far enough from the walls to allow proper ventilation. Inadequate ventilation may cause overheating, which may damage the TV.

NOTE: Before installing your TV, please read the Important Information on page 2.

NOTICE OF POSSIBLE TV STAND INSTABILITY



WARNING: RISK OF SERIOUS PERSONAL INJURY OR DEATH! Use your TV with the Toshiba TV stand recommended below **only!**

Use with other stands may result in instability, causing possible injury or death.

TV Model	TV Stand
32A41	ST3240
36A41	ST3641

Connecting your TV

If you have not connected electronic equipment before, or you have been frustrated in the past, you may wish to read this section. (Cables are not supplied.)

- A coaxial cable is the standard cable that comes in from your antenna or cable converter box. Coaxial cables use “F” connectors.
- Audio and video cables are usually color-coded according to use: yellow for video; red and white for audio. The red audio cable is for the stereo right channel; the white audio cable is for the stereo (or mono) left channel. If you look at the back panel of the TV, you will see that the terminals are color-coded in the same manner as the cables.

NOTE REGARDING PICTURE QUALITY

When connecting video equipment, such as a VCR or DVD player:

- For **GOOD** picture quality: Use regular video cables.
- For **BETTER** picture quality: If your equipment has S-video connections, use S-video cables *instead of* regular video cables.
- For **BEST** picture quality: If your equipment has component video connections (ColorStream™ is Toshiba's brand), use component video cables *instead of* regular or S-video cables. Component video cables come in sets of three.

Note: Do not connect an S-video cable and a regular video cable to VIDEO-1 (on the TV) at the same time. Doing so will distort the picture.

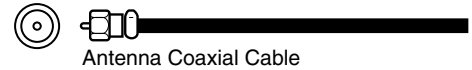

Antenna Coaxial Cable

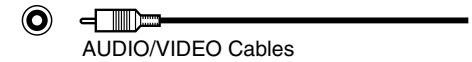

AUDIO/VIDEO Cables

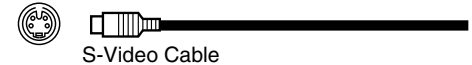

S-Video Cable

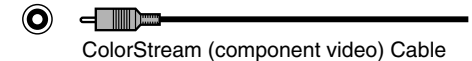

ColorStream (component video) Cable

Caution:

Do not plug in the TV power cord until you have finished connecting all of your equipment.

Connecting a VCR

This connection allows you to watch TV and video programs and record one channel while watching another channel.

You will need:

- one coaxial cable
- one pair of audio cables (one single audio cable for a mono VCR)
- one video cable (for video cable type, see “Note Regarding Picture Quality” above).

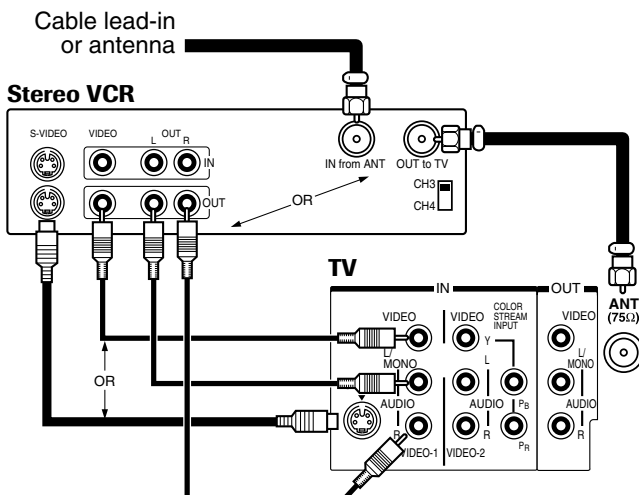

Note:

If you have a mono VCR, connect L/Mono to VCR Audio OUT using only one audio cable.

The VIDEO-2 jacks can be used for connecting a second piece of video equipment, such as a DVD player or camcorder (see “Note Regarding Picture Quality” above).

Connecting a cable converter box

This connection allows you to watch cable and premium channels. Tune the TV to channel 3 or 4 (whichever channel is vacant in your broadcast area), and then use the converter box to change channels.

You will need:

- one coaxial cable

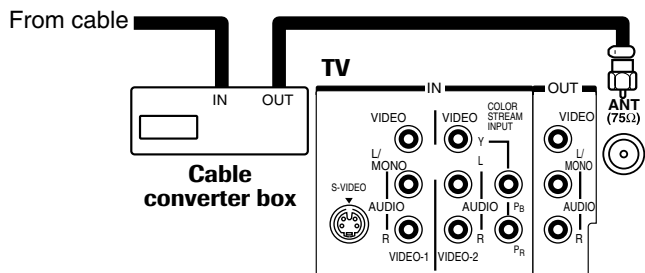

Note:

When you use a converter box with your TV, you may not be able to program certain features using the remote control, such as blocking channels or programming your favorite channels.

Connecting your TV (continued)

Connecting a cable converter box and a VCR

This connection allows you to watch videotapes and watch and record basic and premium cable channels. Tune the TV and VCR channels to 3 or 4 (whichever channel is vacant in your area), and then use the converter box to change channels.

You will need:

- one cable signal splitter
- three coaxial cables
- three coaxial cables
- one pair of audio cables (one single audio cable for a mono VCR)
- one video cable (for video cable type, see “Note Regarding Picture Quality” on page 5).

Note:

If you have a mono VCR, connect TV L/Mono Audio IN to VCR Audio OUT using only one audio cable.

When you use a converter box with your TV, you may not be able to program certain features using the remote control, such as blocking channels or programming your favorite channels.

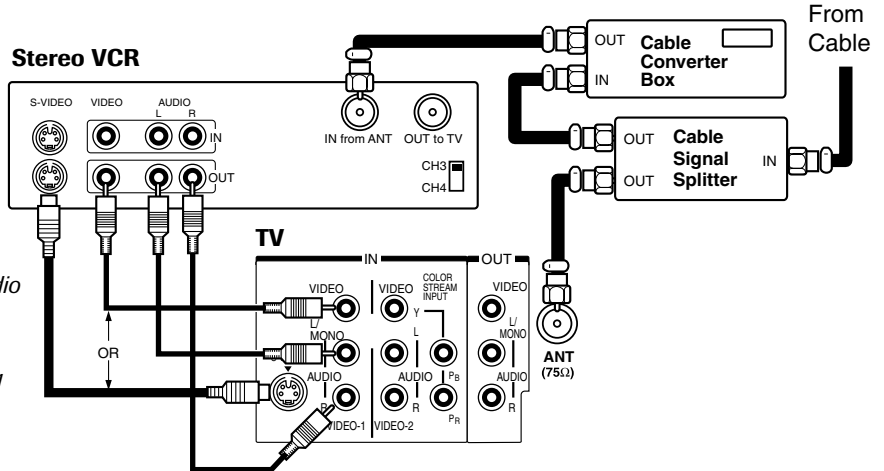

Connecting a satellite receiver and a VCR

This connection allows you to watch satellite, VCR, and TV programs.

You can record one TV channel while watching another channel.

You will need:

- one coaxial cable
- two pairs of audio cables (one single and one pair of audio cables for a mono VCR)
- two video cables (for video cable type, see “Note Regarding Picture Quality” on page 5).

Notes:

- To watch from the satellite receiver, the TV must select VIDEO-1.
- To watch from the VCR, the TV must select VIDEO-2.

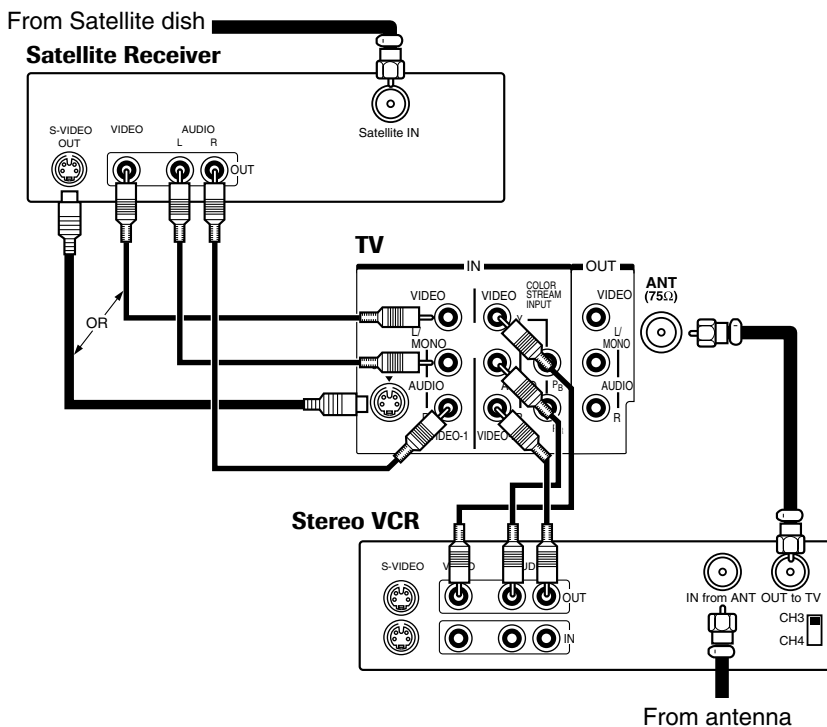

Connecting a DVD player with component video and a VCR

This connection allows you to watch DVD, VCR, and TV programs, and record TV programs. Your TV has ColorStream™ (component video) connections. Connecting your TV to a component video-compatible DVD player (such as a Toshiba DVD player with ColorStream™) can greatly enhance picture quality and performance.

You will need:

- one coaxial cable
- three pairs of audio cables (two single and one pair of audio cables for a mono VCR)
- two video cables (or, if your DVD player has component video, one video cable and one set of component video cables; see “Note Regarding Picture Quality” on page 5).

Caution:

The unauthorized recording of television programs, videotapes, and other materials may infringe upon the provisions of copyright laws.

Note:

- To watch the VCR, the TV must select VIDEO-1.
- To watch the DVD player, the TV must select VIDEO-2.

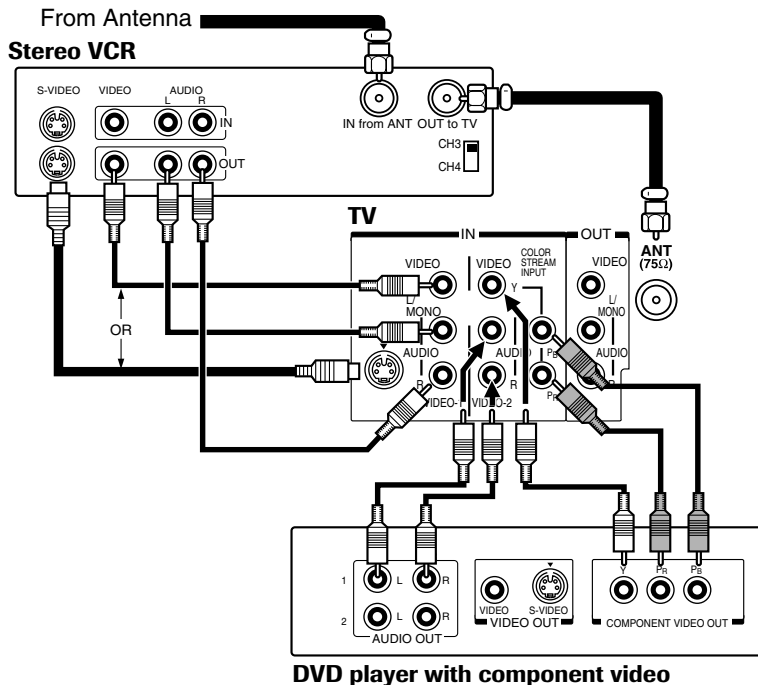

Connecting two VCRs

This connection allows you to record (dub/edit) from one VCR to another VCR while watching a videotape. You also can record from one TV channel while watching another channel.

You will need:

- one coaxial cable
- two pairs of audio cables (two single audio cables for mono VCRs)
- two video cables (for video cable type, see “Note Regarding Picture Quality” on page 5).

Caution:

The unauthorized recording of television programs, videotapes, and other materials may infringe upon the provisions of copyright laws.

Note:

Do not connect the same VCR to both output and input jacks on the TV.

To record (dub/edit) from VCR 1 to VCR 2, the TV must select VIDEO-1, and VCR 2 must select LINE IN.

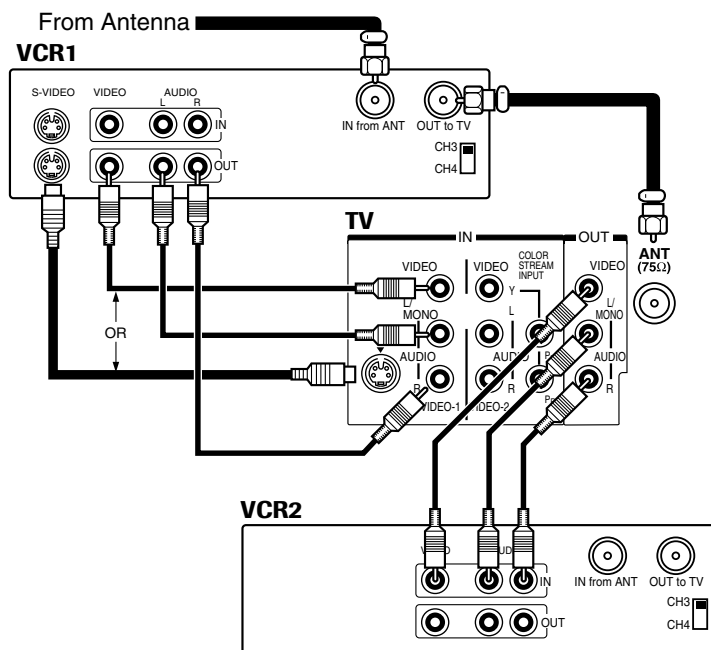

Preparing the remote control for use

Your TV remote control can operate your TV together with most VCR models and cable TV converters, even if they are different brands.

If you have a Toshiba VCR, your TV remote control is already programmed to operate it (see page 10).

If you have a non-Toshiba VCR and/or cable TV converter, you must first program your remote control so it will operate the other equipment (see pages 11–13).

Installing the remote control batteries

- 1 Slide the battery cover off the back of the remote control.

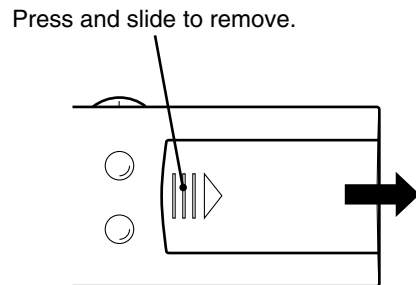

- 2 Install two “AA” size batteries, making sure to match the + and – signs on the batteries to the signs on the battery compartment.

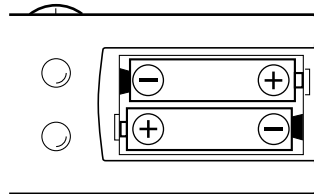

- 3 Slide the battery cover back onto the remote control until the lock snaps.

Caution:

Dispose of batteries in a designated disposal area. Do not throw batteries into a fire.

Do not mix battery types or combine used batteries with new ones.

Remove dead batteries immediately to prevent battery acid from leaking into the battery compartment.

If you do not intend to use the remote control for a long time, remove the batteries.

Note:

If your Toshiba TV remote control does not operate all of the features of your VCR or cable TV converter, you may need to use the remote control that came with your other equipment.

Location of controls on TV and remote control

For details on the use of each control, refer to pages in brackets.

TV front panel

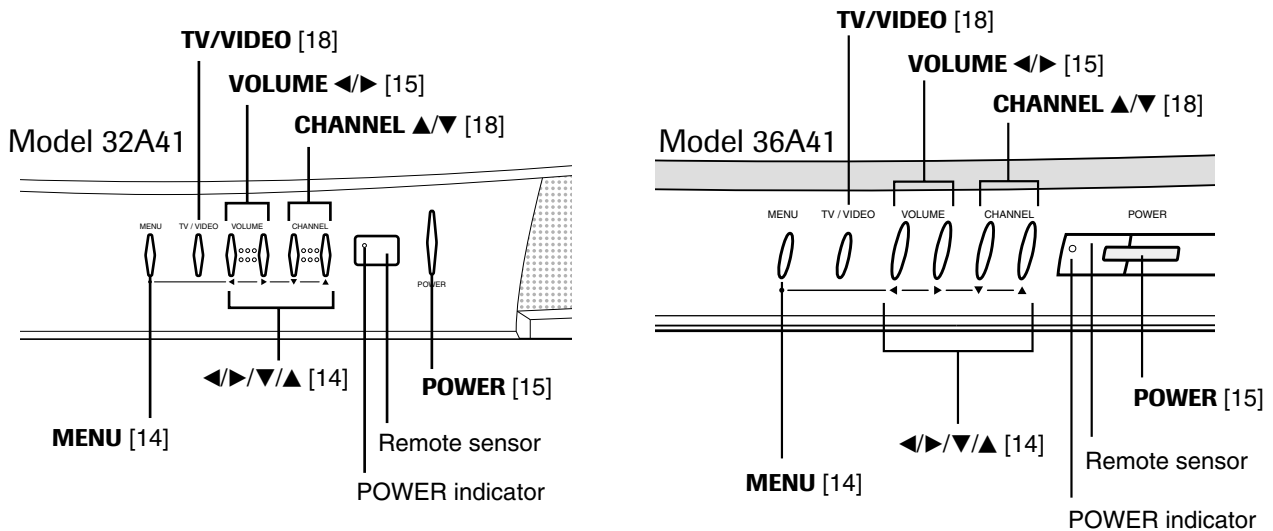

Remote control

- The shaded buttons in the picture below glow in the dark.
- Only the buttons used to operate the TV are described here.

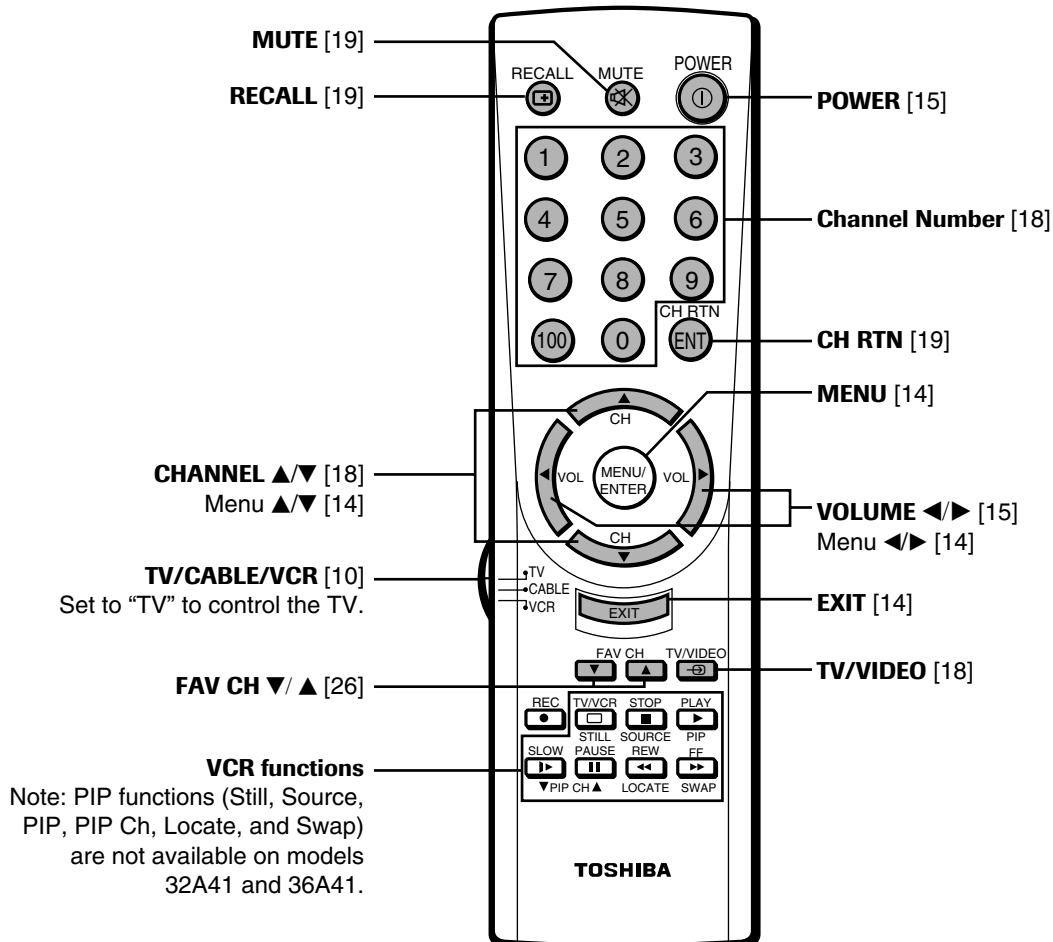

Using the remote control with a VCR or cable TV converter

- To use your TV remote control to operate a VCR, set the **TV/CABLE/VCR** switch to VCR. The shaded buttons shown in the picture below will then operate the VCR; the unshaded buttons will operate the TV as usual.
- To use your TV remote control to operate a cable TV converter, set the **TV/CABLE/VCR** switch to CABLE. The shaded buttons shown in the picture below will then operate the converter; the unshaded buttons will operate the TV as usual.
- If you have a non-Toshiba VCR or cable TV converter, you must first program the remote control to recognize your VCR or converter brand (see pages 11–13 for details).

Point the remote control at the VCR or cable TV converter

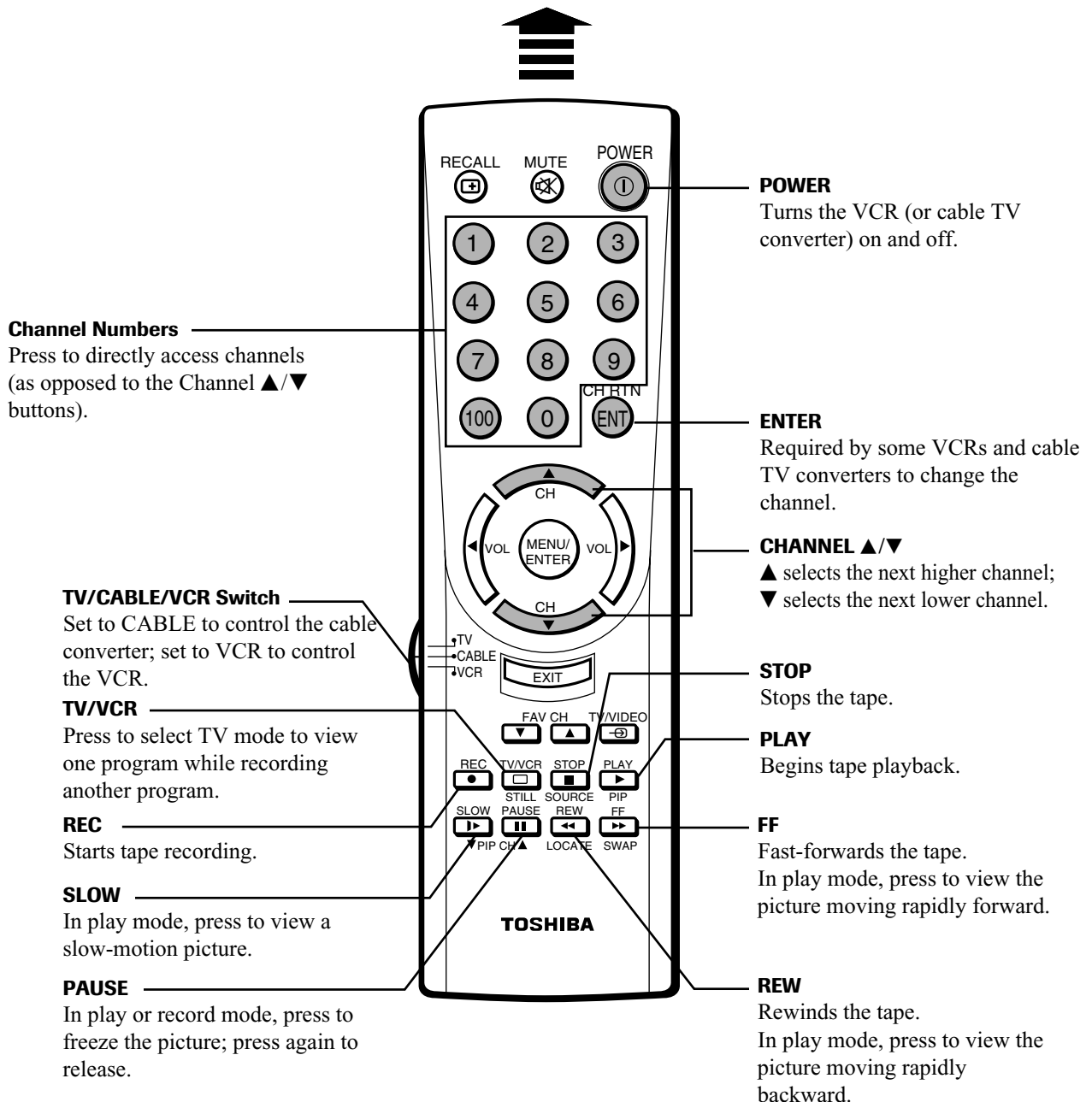

Programming the remote control for use with a non-Toshiba VCR or cable TV converter

Your Toshiba TV remote control is preprogrammed to operate Toshiba brand VCRs and cable TV converters. To program your TV remote control to operate a non-Toshiba VCR or a cable TV converter, follow these steps:

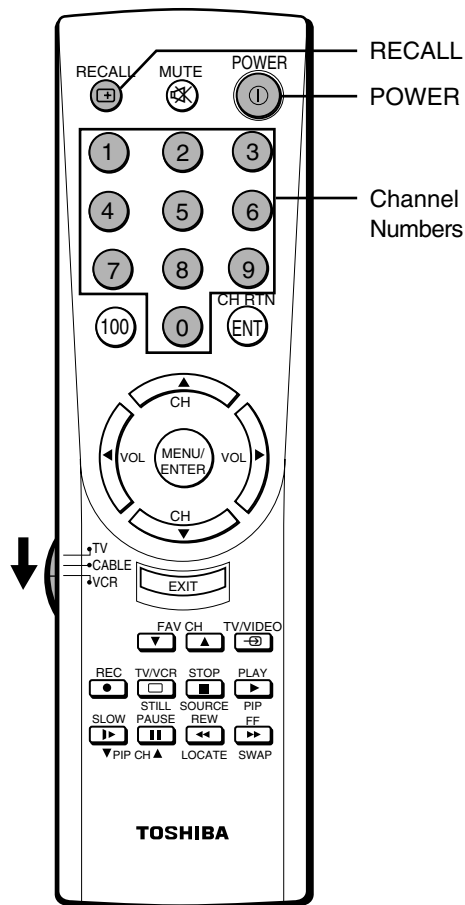

- 1 Find the code for your brand of VCR or cable TV converter in the code tables on pages 12–13.

If more than one code is listed, try each one separately until you find one that works.

- 2 Set the **TV/CABLE/VCR** switch to VCR (for a VCR), or CABLE (for a cable TV converter).
- 3 While holding down **RECALL**, press the **Channel Number** buttons to enter the 3-digit code for your brand of VCR or converter.
- 4 To test the code, turn the VCR or converter on, point the remote control at it, and press **POWER**.

– If the correct code was entered, the VCR or converter will turn off.

– If the VCR or converter does not respond, repeat steps 1–4 using another code.

– If the VCR or converter does not respond to a different code, you will need to use the remote control that came with your VCR or converter.

- 5 Set the **TV/CABLE/VCR** switch to TV to control the TV.

For future reference, write down the code(s) you used:

VCR Code _____

Cable TV Converter Code _____

Note:

You must reprogram the remote control when you change the batteries.

Some newer VCRs respond to either of two codes. These VCRs have a switch labeled "VCR1/VCR2." If your VCR has this kind of switch and does not respond to the codes for your VCR brand, set the switch to the other position ("VCR1" or "VCR2") and reprogram the remote control.

Programming the remote control for use with a non-Toshiba VCR or cable TV converter (continued)

In some rare cases, you may not be able to operate your non-Toshiba equipment with your TV remote control. Your other equipment may use a code that is not recognized by the TV remote control. If this happens, you will need to use the remote control provided with your other equipment.

VCR code table

BRAND NAME	CODE NUMBER	BRAND NAME	CODE NUMBER	BRAND NAME	CODE NUMBER
Adventura	019	Jensen	060	Radio Shack	019,056,344
Aiko	297	JVC	027,060,086	Radix	056
Aiwa	019	Kenwood	057,060,086	Randex	056
Akai	060,068,080,125, 261	KLH	091	RCA	061,079,084,096, 124,125,168,221
American High	054	Kodak	054,056	Realistic	019,054,056,065, 066,067,081,085, 123,259
Asha	259	Lloyd	019	Ricoh	053
Audiovox	056	Lloyd's	227	Runco	058
Beaumarck	259	Logik	091	Samsung	064,259
Bell & Howell	123	LXI	056	Sanky	058,067
Bell & Howell	123	Magnavox	054,058,100,129,168	Sansui	060,086
Brandt	206	Magnin	259	Sanyo	065,066,123,259
Broksonic	140,203,230,314, 380	Marantz	054,100	Scott	062,064,140,203, 229,230,231
Calix	056	Marta	056	Sears	054,056,061,065, 066,073,085,123, 124
Canon	054	Matsushita	054	Sharp	067,081
Capehart	039	MEI	054	Shintom	091
Carver	100	Memorex	019,054,056,058, 065,066,067,123, 259	Shogun	259
CCE	091,297	MGA	062,080	Singer	091
Citizen	056,297	MGN Technology ...	259	Sony	051,052,053,054
Colt	091	Minolta	061,124	STS	061
Craig	056,066,091,259	Mitsubishi	062,080,086,094	Sylvania	019,054,062,100, 129
Curtis Mathes	054,060,079	Motorola	054,067	Symphonic	019,344
Cybernex	259	MTC	019,259	Tatung	060
Daewoo	039,064,297	Multitech	019,091	Teac	019,060
Daytron	039	NAD	077	Technics	054,181
Dynatech	019	NEC	057,059,060,069,086	Teknika	019,054,056,071
Electrohome	056	Nikko	056	Telefunken	206
Electrohome	056	Noblex	259	TMK	227,259
Emerex	051	Olympus	054	Toshiba	062,064,085,229, 231,385
Emerson	019,021,056,062, 080,087,140,203, 227,228,230,231, 297,313,314,380, 498	Optimus	056,067,077,123	Totevision	056,259
Fisher	066,073,085,123	Optonica	081	Unitech	259
Fuji	052,054	Orion	498	Vector	064
Funai	019,344	Panasonic	054,096,181,244,473	Vector Research	057,059
Garrard	019,344	Penney	054,056,057,059, 061,073,259	Video Concepts	059,064,080
GE	054,079,084,221	Pentax	061,084,124	Videosonic	259
Goldstar	037,056,057	Philco	054	Wards	019,054,061,066, 067,081,091,168, 231,259
Gradiente	019	Philips	054,081,100,129	XR-1000	019,054,091
Harley Davidson	019	Pilot	056	Yamaha	057
Harman/Kardon	057,094	Pioneer	077,086	Zenith	052,053,058
Harwood	087,091	Portland	039		
Headquarter	065	Protec	091		
HI-Q	066	Pulsar	058		
Hitachi	060,061,084,124, 185, 254	Quarter	065		
		Quarts	065		
		Quasar	054,096		

Cable TV converter code table

BRAND NAME	CODE NUMBER	BRAND NAME	CODE NUMBER
ABC	020,022,026,027, 030,032,033,036, 066	Regency	021
Antronix	041	Rembrandt	030,089
Archer	041,058,172	Runco	019
Belcor	075	Samsung	059,163
Cable Star	075	Scientific Atlanta	025,027,036,296
Cabletenna	041	Signal	034,059
Cableview	041	Signature	030
Century	172	SL Marx	059
Citizen	172	Sprucer	040
Colour Voice	044,050	Standard Components	174
Comtronics	059,079	Starcom	022,034,066
Contec	038	Stargate	034,059
Dae Ryung	027	Starquest	034
Eastern	021	Sylvania	020
Focus	419	Televue	059
Garrard	172	Texscan	020
GC Electronics	075	Tocom	031,032,078
Gemini	034,089	Toshiba	019
General Instrument	030,295	Tusa	034
Goldstar	059,163	Unika	041,172
Hamlin	028,039,053,278, 292	United Artists	026
Hitachi	030	United Cable	022
Hytex	026	Universal	041,058,075,172
Jasco	172	Viewstar	046,079,230
Jerrold	022,030,031,033 034,066,295	Zenith	019
Macom	052	Zentek	419
Magnavox	046		
Memorex	019		
Movie Time	175		
NSC	089,175		
Oak	026,038,267		
Panasonic	019,040,126		
Paragon	019		
Philips	044,046,047,048 049,050,172		
Pioneer	042,163,552		
Popular Mechanics	419		
Pulsar	019		
RCA	040		
Recoton	419		
Regal	039,278,292		

Menu function (general instructions)

To adjust any TV feature, you must use the menu function. You can access the menus using the buttons on the TV or remote control. Model 32A41 is used for illustration purposes.

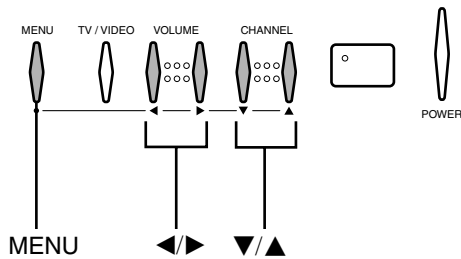

The following are general instructions for using the menu system:

- 1 Repeatedly press **MENU** to select a menu (Picture, Audio, Setup, or Option, as shown below).
- 2 Press **▼** or **▲** to select the function you want to adjust in the menu. The selected function will be displayed in purple.
- 3 Press **◀** or **▶** to adjust the selected function.
- 4 The menus automatically disappear from the screen if no adjustments are made within 15 seconds. To clear an on-screen menu instantly, press **EXIT** on the remote control.

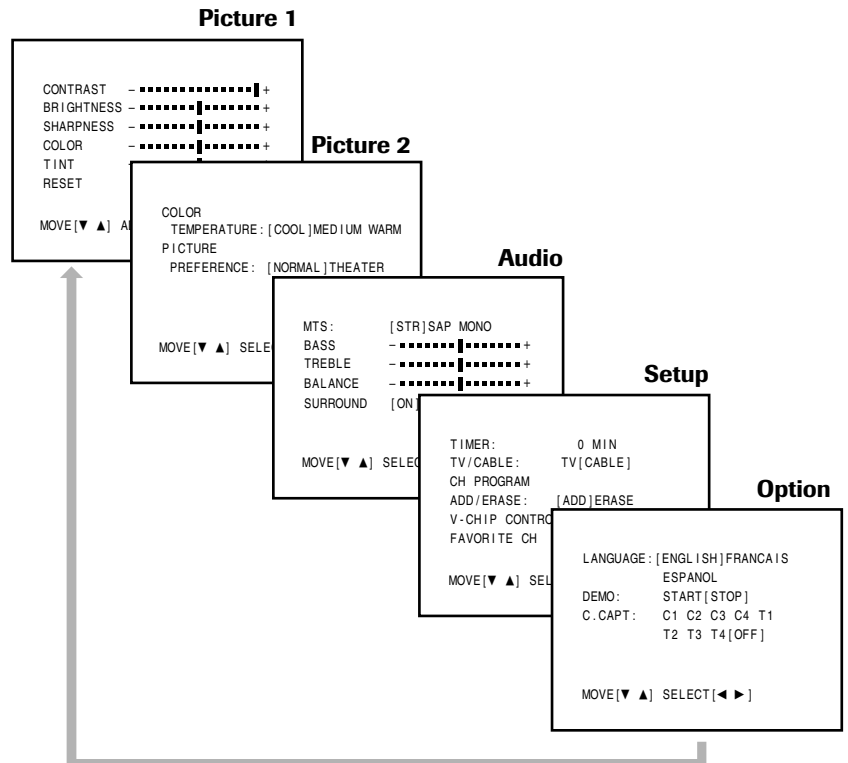
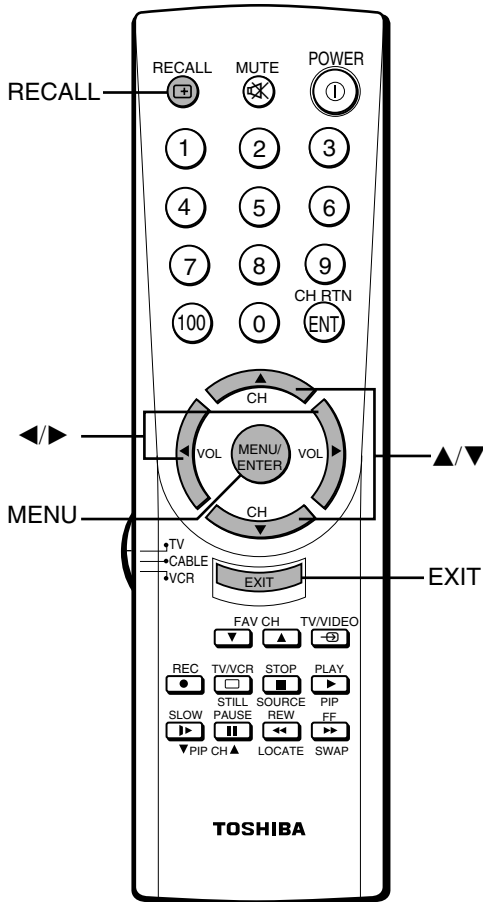

Note:

The **◀▶** buttons function as **VOLUME** **◀▶** buttons when no menu is on-screen.

The **▲▼** buttons function as **CHANNEL** **▲▼** buttons when no menu is on-screen.

Models 32A41 and 36A41 do not have PIP features.

First-time operation

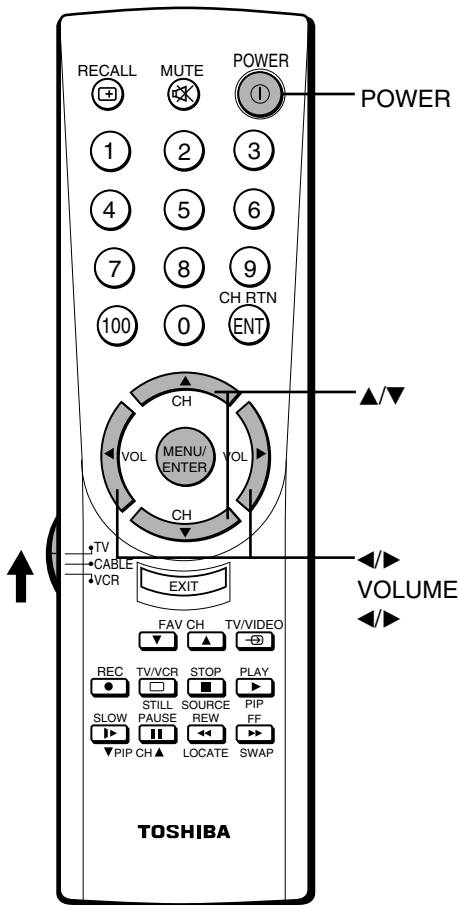
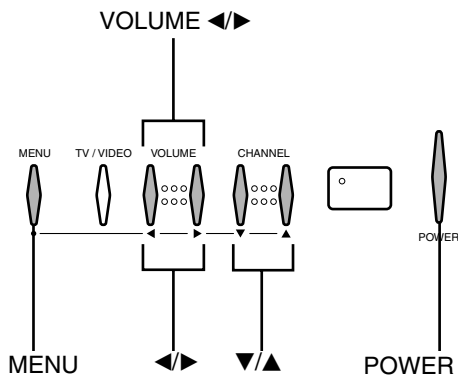

Turning the TV set on

- 1 Set the **TV/CABLE/VCR** switch on the remote control to TV.
- 2 Press **POWER** to turn the TV on.
To turn the TV off, press **POWER** again.



- 3 Press **VOLUME** \leftarrow/\rightarrow to adjust the volume.
To increase the volume, press \rightarrow .
To decrease the volume, press \leftarrow .

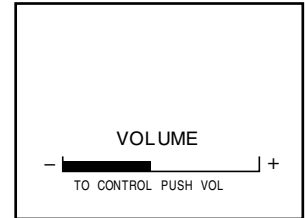

Selecting the on-screen display language

- 1 Press **MENU** until the Option menu is displayed on-screen.
- 2 Press \uparrow or \downarrow repeatedly until "LANGUAGE" is displayed in purple.
- 3 Press \leftarrow or \rightarrow until your desired language is displayed in purple.
For example, if you select FRANCAIS, the menu display language changes to French.

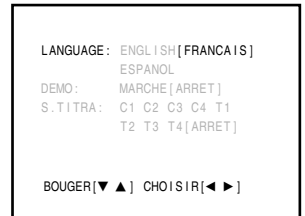
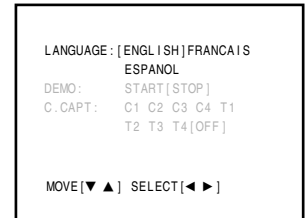

Understanding the Auto Power Off feature

The TV automatically turns off after 15 minutes if it is tuned to a vacant channel or a station that has completed its broadcast for the day. This feature does not operate when the TV is in VIDEO mode.

Understanding the Last Mode Memory feature

If the power is cut off while you are viewing the TV, the Last Mode Memory feature automatically turns the TV on when the power is resupplied. If the power is going to be off for a long time and you are going to be away from your TV, unplug the power cord to prevent the TV from turning on in your absence.

Programming the channel memory

The channel memory is the list of TV channels your TV stops on when you press **CHANNEL ▲/▼**.

First, use the TV/CABLE and CH PROGRAM functions (below) to program all active channels in your area into the channel memory. Then use the ADD/ERASE function (page 17) to add/erase individual channels in the memory.

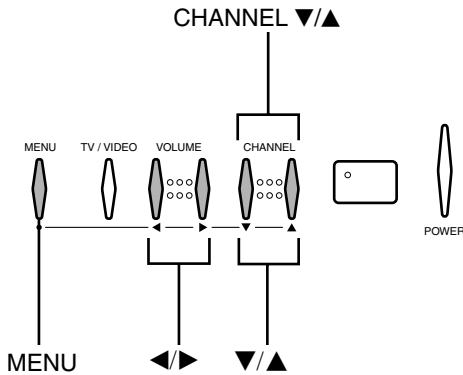

TV/CABLE function

- 1 Press **MENU** until the Setup menu is displayed on-screen.
- 2 Press **▲** or **▼** until TV/CABLE is displayed in purple.

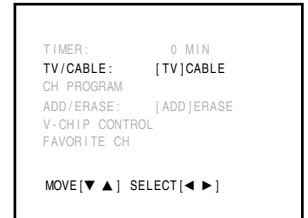

- 3 Press **◀** or **▶** until the mode that corresponds to your TV signal system displays in purple.

TV: TV broadcast signals
(VHF channels 2 through 13 and
UHF channels 14 through 69)

CABLE: Cable TV signals
(Cable channels 1 through 125)

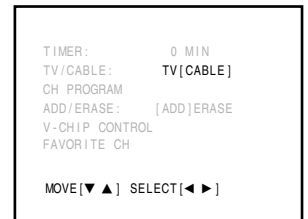

CH PROGRAM function

Use the CH PROGRAM function to automatically add all active channels to the channel memory.

- 1 Press **MENU** until the Setup menu is displayed on-screen.
- 2 Press **▲** or **▼** repeatedly until "CH PROGRAM" is displayed in purple.

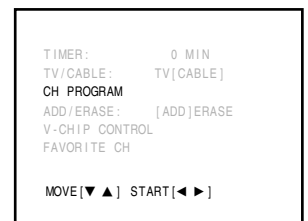

- 3 Press **◀** or **▶** to start channel programming. The TV automatically cycles through all the TV or CABLE channels (depending on the mode selected), and stores the active channels in the channel memory.

- 4 When channel programming is done, you will see the message, "Ch Programming Completed."

- 5 Press **CHANNEL ▲** or **▼** to scan through the programmed channels.

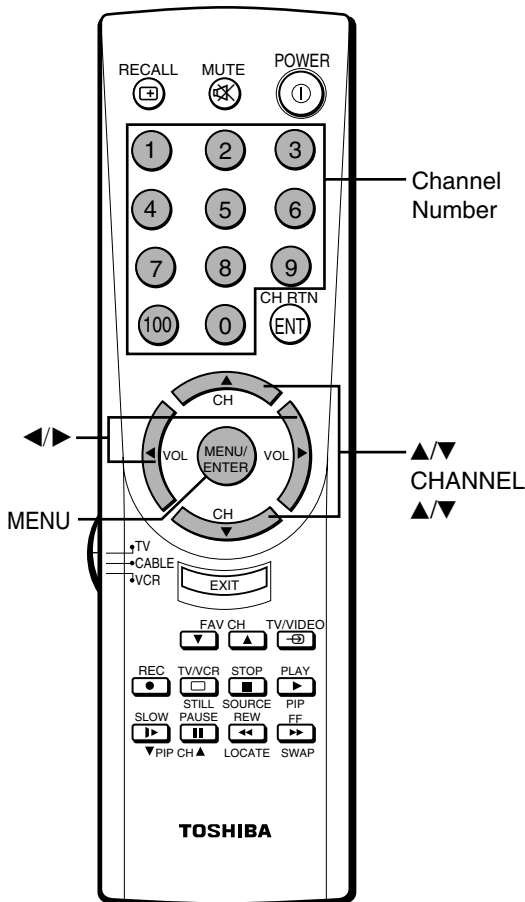
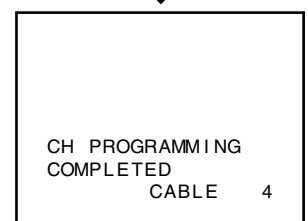
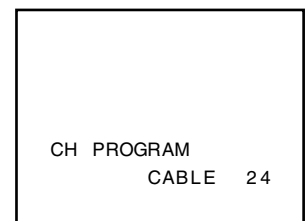

ADD/ERASE function

After using the CH PROGRAM function to automatically program channels into the channel memory, you can use the ADD/ERASE function to manually add or erase individual channels, as follows:

1 Select the channel you want to add or erase. If you are adding a channel, you must use the **Channel Number** buttons to select the channel.

2 Press **MENU** until the Setup menu is displayed on-screen.

3 Press **▲** or **▼** until ADD/ERASE is displayed in purple.

```
TIMER:          0 MIN
TV/CABLE:      [TV]CABLE
CH PROGRAM
ADD/ERASE:    [ADD]ERASE
V-CHIP CONTROL
FAVORITE CH

MOVE[▼▲] SELECT[◀▶]
```

4 To add the channel:

Press **◀** or **▶** until ADD is displayed in purple, indicating that the channel has been added to the channel memory.

To erase the channel:

Press **◀** or **▶** until ERASE is displayed in purple, indicating that the channel has been erased from the channel memory.

```
TIMER:          0 MIN
TV/CABLE:      [TV]CABLE
CH PROGRAM
ADD/ERASE:    ADD [ERASE]
V-CHIP CONTROL
FAVORITE CH

MOVE[▼▲] SELECT[◀▶]
```

```
TIMER:          0 MIN
TV/CABLE:      [TV]CABLE
CH PROGRAM
ADD/ERASE:    [ADD]ERASE
V-CHIP CONTROL
FAVORITE CH

MOVE[▼▲] SELECT[◀▶]
```

5 Repeat steps 1–4 for other channels.

6 Press **▲** or **▼** to select another item in the menu, or press EXIT on the remote control to return to viewing.

You have now finished programming the channel memory.

CABLE channel reference chart

Number on this TV	Corresponding CABLE channel	Number on this TV	Corresponding CABLE channel
1	A-8	67	67
5	5(A-7)	68	68
6	6(A-6)	69	69
		⋮	⋮
14	A		
15	B	92	92
16	C	93	93
		⋮	⋮
34	U	95	A-5
35	V	96	A-4
36	W	97	A-3
37	AA	98	A-2
38	BB	99	A-1
		100	100
		101	101
60	XX	101	101
61	YY	102	102
62	ZZ		
		⋮	⋮
63	AAA	123	123
64	BBB	124	124
65	65	125	125
66	66		

The above chart is typical of many cable system channel allocations. If in doubt, consult your cable company.

Watching TV programs or videotapes

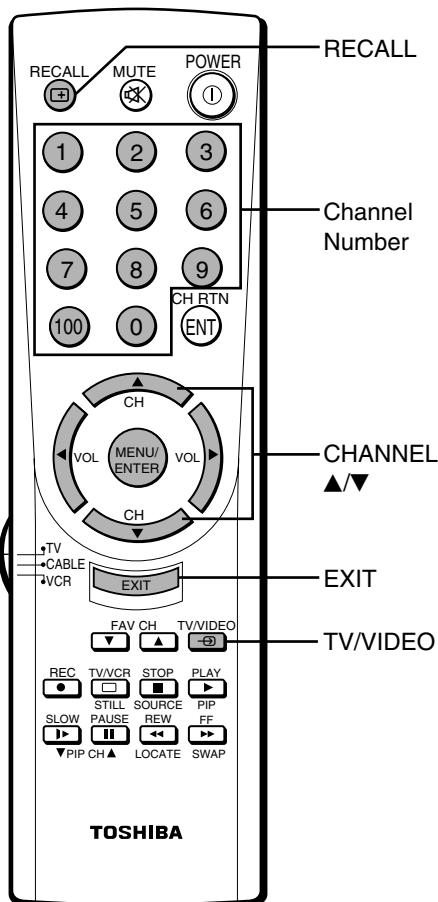
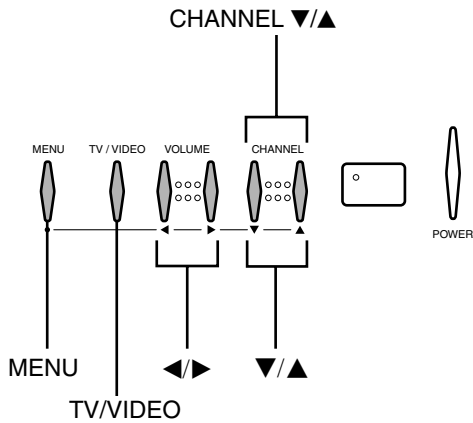

Selecting a TV channel

Select a channel in one of the following two ways:

- **Scan through the programmed channels in numerical sequence:**
 - Press **CHANNEL ▲** to select the next higher channel.
 - Press **CHANNEL ▼** to select the next lower channel.
 - Continue pressing **CHANNEL ▲** or **▼** to select the next programmed channel.
- **Select a channel directly:**
 - Press the **Channel Number** buttons (0–9 and 100).
 - For example:
 - To select channel 4, press 0—4.
 - To select channel 38, press 3—8.
 - To select channel 125, press 100—2—5.

If you cannot select a specific channel, make sure the TV/CABLE function is set correctly (see page 16).

Selecting the video input source

You can use the **TV/VIDEO** button to view a signal coming from other video equipment connected to your TV (such as a VCR or DVD player). See “Connecting your TV” on page 5.

Note: To operate your video equipment properly, refer to the instructions provided with the video equipment.

- 1 Turn the TV and video equipment on.
- 2 Press **TV/VIDEO** to select VIDEO 1 or VIDEO 2. The selected source will be displayed in purple.



- 3 Operate the video equipment normally.

About the DEMO (demonstration) mode

When the DEMO mode is activated, your TV automatically displays a variety of its on-screen menus and special features. This function is provided for demonstration purposes only.

To start the demo:

- 1 Press **MENU** until the Option menu is displayed on-screen.
- 2 Press **▲** or **▼** until DEMO is displayed in purple.
- 3 Press **◀** or **▶** to select START. The on-screen demo starts after about 15 seconds.

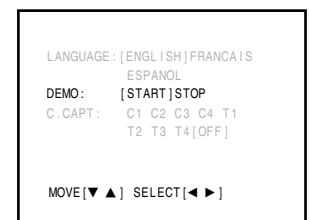

To stop the demo:

- 1 Press **EXIT** or **RECALL** on the Remote, or select STOP in the menu.

Convenient remote control functions

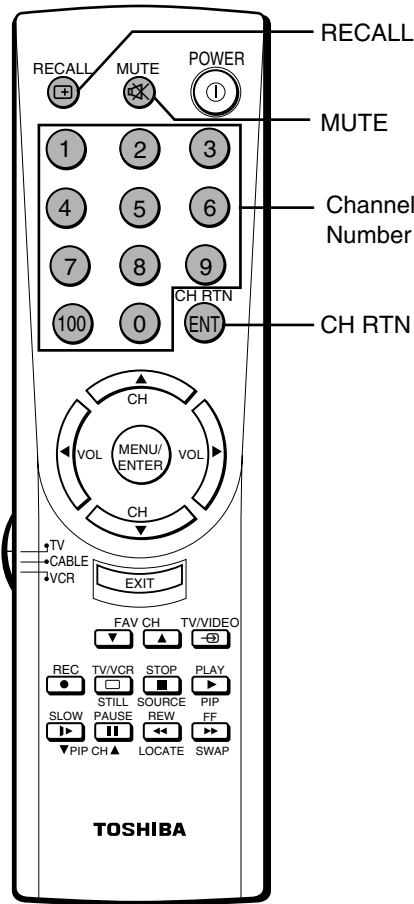

Displaying on-screen information

Press **RECALL** to display the following information on-screen:

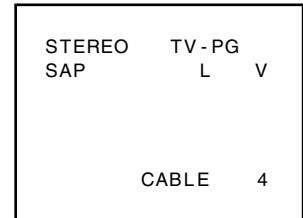

- Channel number or VIDEO mode selected (see page 18)
- Stereo or SAP audio status (see pages 24–25)
- V-CHIP rating (see pages 28–31)

Muting the sound

Press **MUTE** to turn off the sound. The word “MUTE” will display on-screen as shown. This is useful during telephone calls or other interruptions.

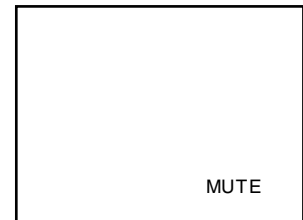

To restore the sound, press **MUTE** again.

Note: When **MUTE** is pressed, the Closed Captioned feature “C1” is activated (“MUTE” on the screen display will disappear). To deactivate, press **MUTE** again. (This feature functions only when the Closed Caption mode is set to OFF.)

Changing quickly between two channels

The **CH RTN** function allows you to switch back and forth between the current and previous channels without entering the channel number each time.

To operate the CH RTN function:

- 1 Select the first channel you want to view.
- 2 Select the second channel using the **Channel Number** buttons.
- 3 Press **CH RTN**. The previous channel will return.

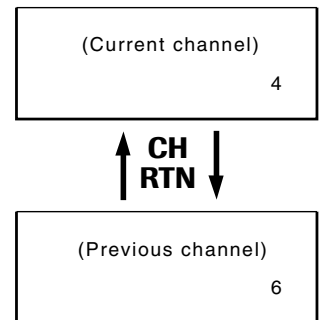

Each time you press **CH RTN**, the TV will switch back and forth between the two channels.

Adjusting the picture

You can adjust the picture quality (CONTRAST, BRIGHTNESS, SHARPNESS, COLOR and TINT) to suit your taste.

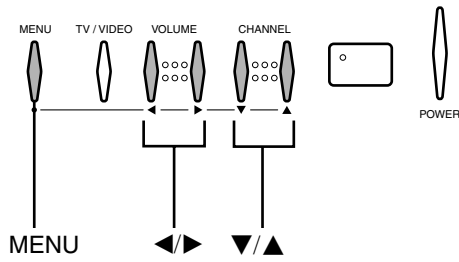

Adjusting the picture quality

- 1 Press **MENU** until the Picture 1 menu is displayed on-screen.
- 2 Press **▲** or **▼** until the item you want to adjust is displayed in purple.

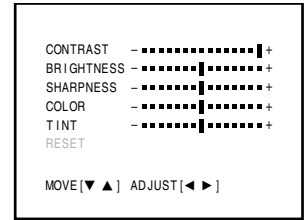

- 3 Press **◀** or **▶** to adjust the item.

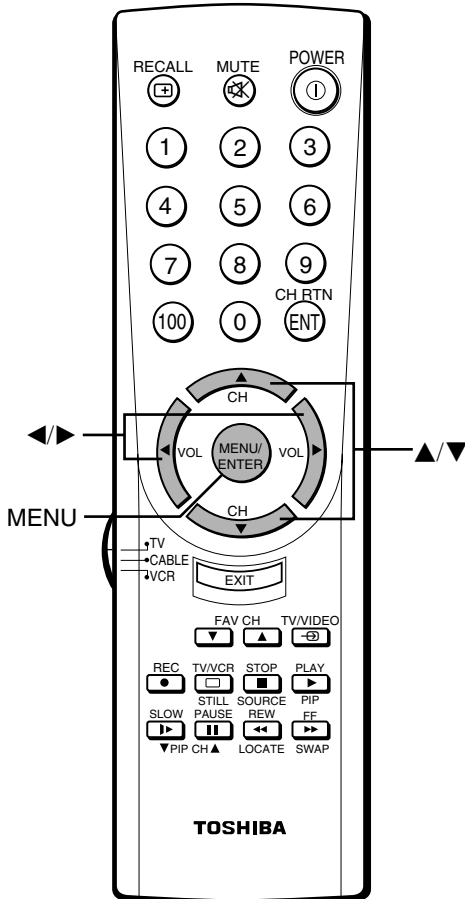
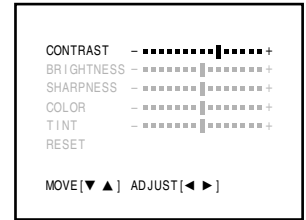

Selection	Pressing	
	◀	▶
CONTRAST	lower	higher
BRIGHTNESS	darker	lighter
SHARPNESS	softer	sharper
COLOR	paler	deeper
TINT	reddish	greenish

To reset the Picture and Sound adjustments to the factory settings (maximum CONTRAST and all other adjustments centered):

- 1 Press **MENU** until the Picture 1 menu is displayed on-screen.
- 2 Press **▲** or **▼** until RESET is displayed in purple.
- 3 Press **◀** or **▶**.

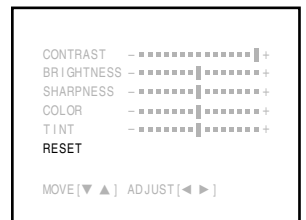

Selecting the color temperature

The color temperature modes change the color tones of the picture.

- 1 Press **MENU** until the Picture 2 menu is displayed on-screen.
- 2 Press **▼** or **▲** until **COLOR TEMPERATURE** is displayed in purple.

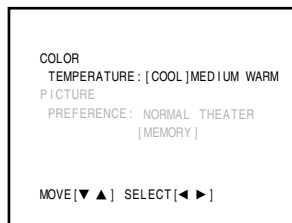

- 3 Press **◀** or **▶** until the desired mode is displayed in purple.

Mode	Picture tone
COOL	Bluish
MEDIUM	Neutral
WARM	Reddish

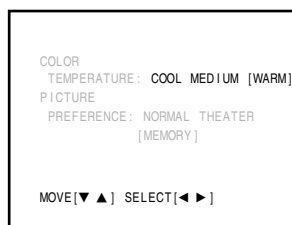

Note:

The **RESET** function returns the picture and audio functions to the following factory settings:

- **CONTRAST** Max.
- **BRIGHTNESS** Center
- **COLOR** Center
- **TINT** Center
- **SHARPNESS** Center
- **COLOR TEMPERATURE** COOL
- **PICTURE PREFERENCE** NORMAL
- **BASS** Center
- **TREBLE** Center
- **BALANCE** Center

Selecting the picture preference function

You can adjust the picture qualities to one of the following modes:

Mode	Picture quality
NORMAL	Normal picture qualities (factory-set)
THEATER	Movie-like picture qualities (factory-set)
MEMORY	The picture qualities you adjusted (see “Adjusting the picture quality” on page 20 and “Selecting the color temperature” above)

- 1 Press **MENU** until the Picture 2 menu is displayed on-screen.
- 2 Press **▼** or **▲** until **PICTURE PREFERENCE** is displayed in purple.
- 3 Press **◀** or **▶** until the desired mode is displayed in purple.

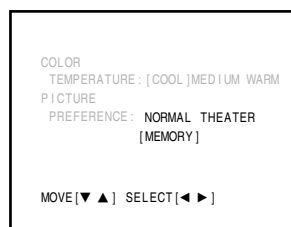
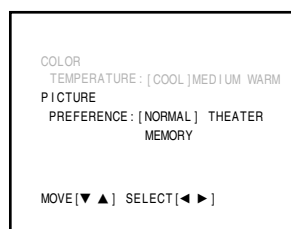

Adjusting the sound

You can adjust the sound quality (BASS, TREBLE and BALANCE) to suit your taste.

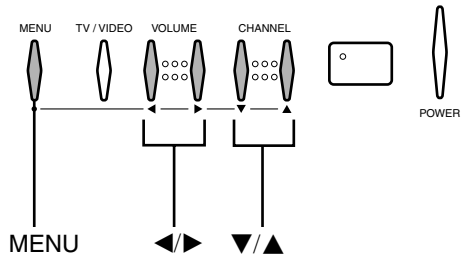

Adjusting the sound quality

- 1 Press **MENU** until the Audio menu is displayed on-screen.
- 2 Press **▲** or **▼** until the item you want to adjust is displayed in purple (bass, treble, or balance).

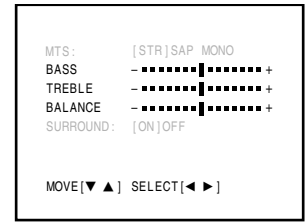

- 3 Press **◀** or **▶** to adjust the level.

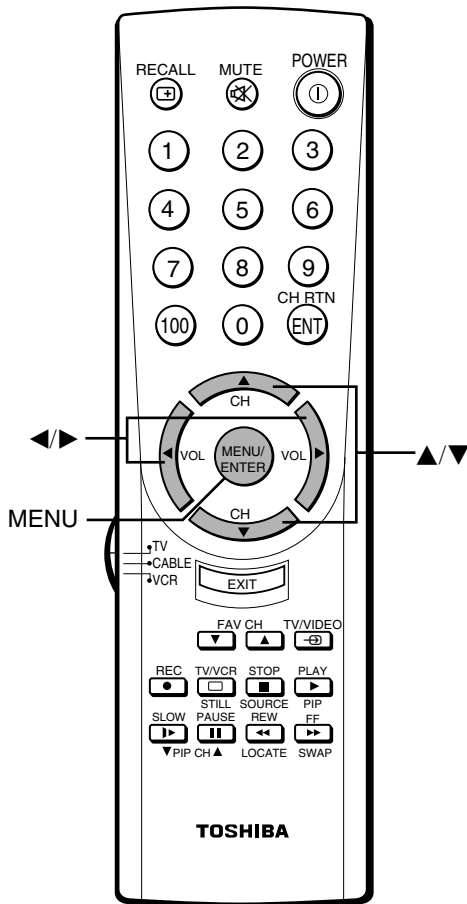
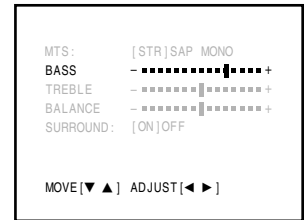

Selection	Pressing	
	◀	▶
BASS	weaker	stronger
TREBLE	weaker	stronger
BALANCE	decreases the right channel	decreases the left channel

Using the off-timer (sleep timer)

You can use the off-timer to set the TV to turn off automatically after a specified amount of time (in 10-minute increments up to 3 hours).

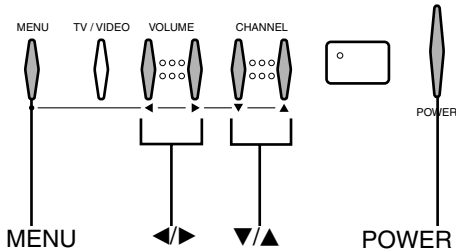

Setting the off-timer

1 Press **MENU** until the Setup menu is displayed on-screen.

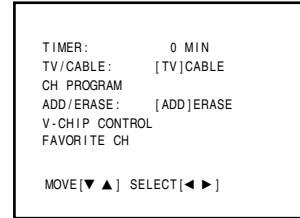

2 Press **▲** or **▼** until **TIMER** is displayed in purple.

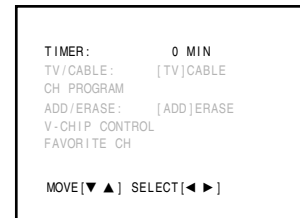

3 Press **◀▶** to enter the length of time until the TV turns off (in 10-minute increments to a maximum of 180 min.).

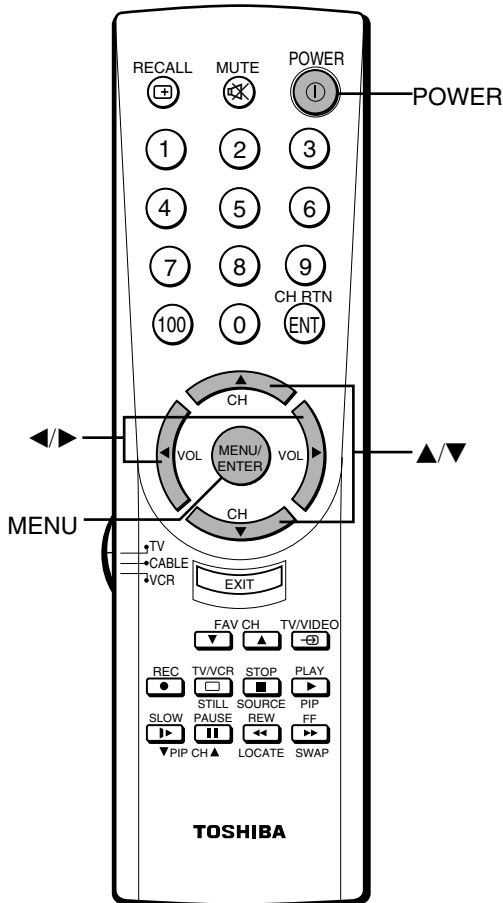
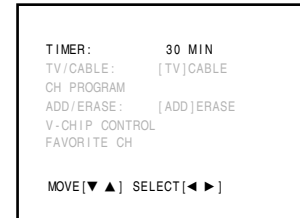
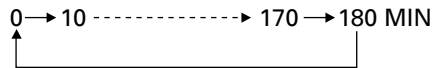

Canceling the off-timer

Press **POWER** two times, once to turn the TV off and once to turn it on again.

Selecting stereo/SAP broadcasts

The MTS (multi-channel TV sound) feature has the following functions:

- **Stereo Sound:** Select either high fidelity stereo sound or monaural (mono) sound.
- **SAP:** Activate the SAP (second audio program), which replaces the regular audio with a second language or other information (when provided by individual stations).
- **Surround Sound:** Activate the surround sound effect.

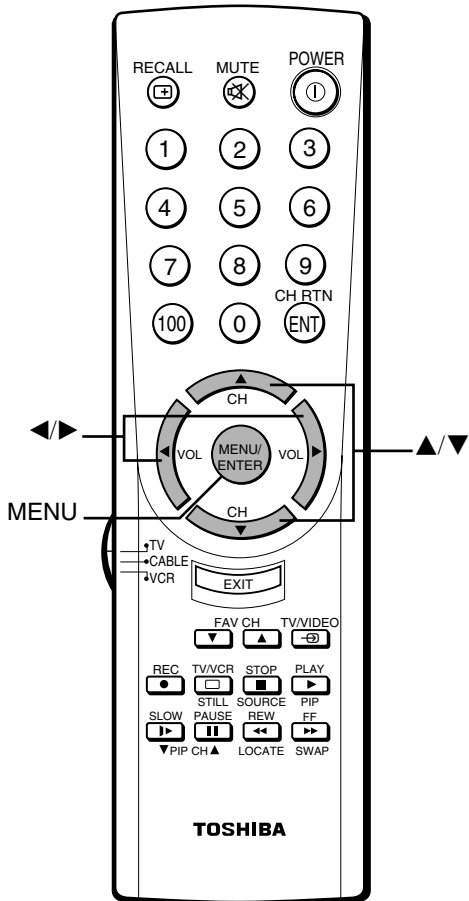
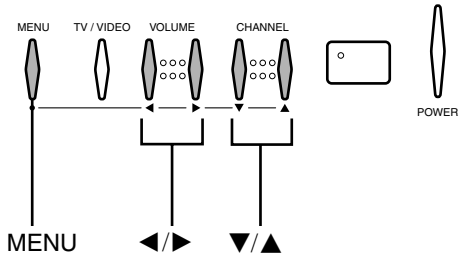

Note: The MTS feature is not available when the TV is in VIDEO mode.

Listening to stereo sound

When the TV receives a stereo broadcast, the word “STEREO” displays on-screen every time you turn on the TV, change the channel, or press **RECALL**.

To select the STR (stereo) mode:

- 1 Press **MENU** until the Audio menu is displayed on-screen.
- 2 Press **▲** or **▼** until MTS is displayed in purple. If a stereo broadcast is being received, “STR” will display in yellow in the menu.
- 3 Press **◀** or **▶** until STR is displayed in purple.

In general, you can leave the TV in STR (stereo) mode because it automatically outputs the type of sound being broadcast (stereo or mono).

If the stereo sound is noisy, select MONO to reduce the noise.

Activating the surround sound effect

- 1 Select the STR (stereo) mode as described above.
- 2 Press **MENU** until the Audio menu is displayed on-screen.
- 3 Press **▲** or **▼** until SURROUND is displayed in purple.
- 4 Press **◀** or **▶** to select ON.

In general, you can leave the SURROUND mode on because it automatically outputs the type of sound being broadcast (surround/ stereo or mono).

To deactivate the surround sound effect:
Select OFF in step 4 above.

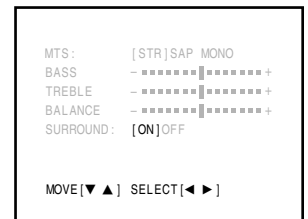
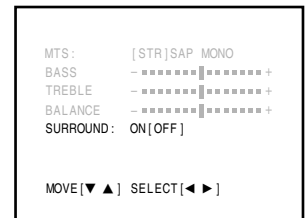
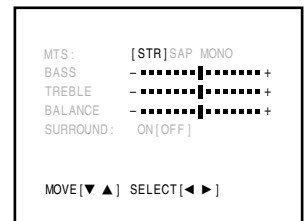
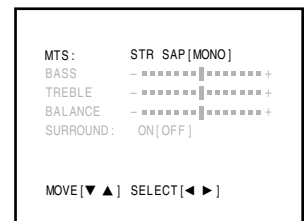
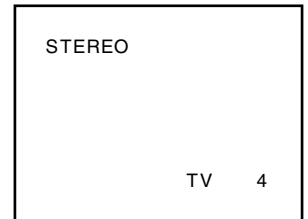

Listening to a second audio program (SAP)

When the TV receives an SAP broadcast (typically a second language), “SAP” displays on-screen every time you turn the TV on, change the channel, or press **RECALL**.

To activate the SAP feature (when provided by individual stations):

- 1 Press **MENU** until the Audio menu is displayed on-screen.
- 2 Press **▼** or **▲** until **MTS** is displayed in purple.
If an SAP broadcast is received, “SAP” will display in yellow in the menu.
- 3 Press **◀** or **▶** until **SAP** displays in purple.
You will hear the second audio program but see the normal picture.

To deactivate the SAP feature:

Select **STR** in step 3, above.

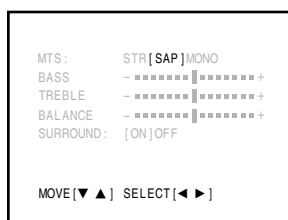
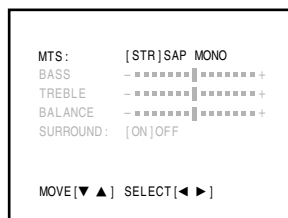
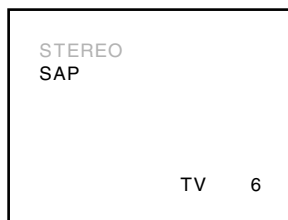

Using the favorite channel programming feature

The Favorite Channel Programming feature allows you to program up to 12 channels into the favorite channel memory. Once programmed, press the **FAV CH** ▼/▲ buttons on the remote control to scan through your favorite channels only, skipping other channels you do not normally view. You can still use the **CHANNEL** ▼/▲ buttons to scan through all the channels you programmed into the regular channel memory (see page 16).

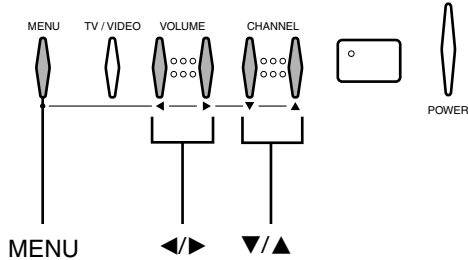

Programming your favorite channels

- 1 Select a channel you want to program as a favorite channel.

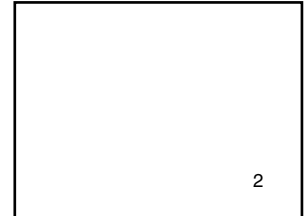

- 2 Press **MENU** until the Setup menu is displayed on-screen.
- 3 Press ▲ or ▼ until FAVORITE CH is displayed in purple.

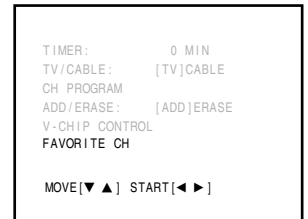

- 4 Press ◀ or ▶ to display the FAVORITE CH program menu.

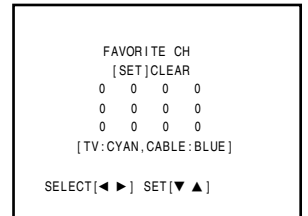

- 5 Press ◀ or ▶ to select SET. Then press ▲ or ▼ until the channel number to be programmed ("2" in this example) replaces "0."

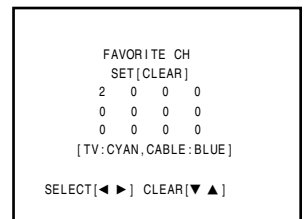

- 6 Repeat steps 1–5 for your other favorite channels (for a maximum of 12 channels).

To clear channels from the favorite channel memory:

Select CLEAR in step 5 above. Then press ▲ or ▼ until "0" replaces the channel number to be erased.

Selecting your favorite channels

To select the favorite channels you have programmed, use the **FAV CH** ▼/▲ buttons on the remote control (instead of the **CHANNEL** ▲/▼ buttons).

Note: The **FAV CH** ▼/▲ buttons will not function until you have programmed your favorite channels.

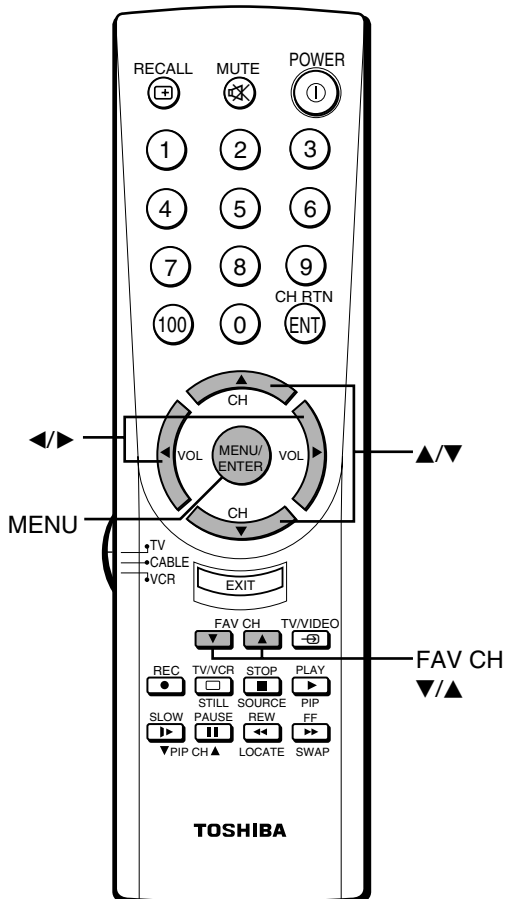

Using the closed caption feature

The closed caption feature has two options: captions or text. A caption is a printed version of the dialogue, narration, and/or sound effects of a program. Text is information not related to the program (such as stock or weather reports) that appears on-screen (when provided by individual stations).

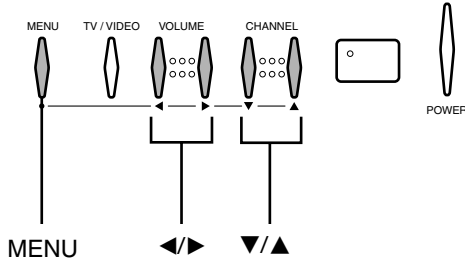

Viewing captions or text

- 1 Select the program you want to watch. Closed-captioned programs are usually noted as "CC."
- 2 Press **MENU** until the Option menu is displayed on-screen.
- 3 Press **▲** or **▼** until C.CAPT is displayed in purple.
- 4 Press **◀** or **▶** to select the desired closed caption mode, as follows:

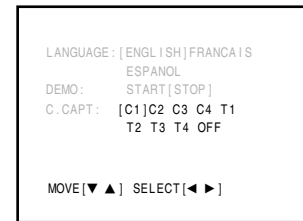
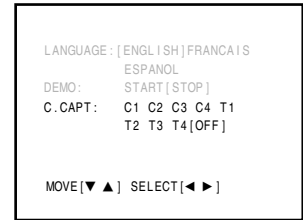

- Select C1, C2, C3, or C4 to view captions. Select C1 for translation of the primary language in your area.
- Select T1, T2, T3, or T4 to view Text (if available).

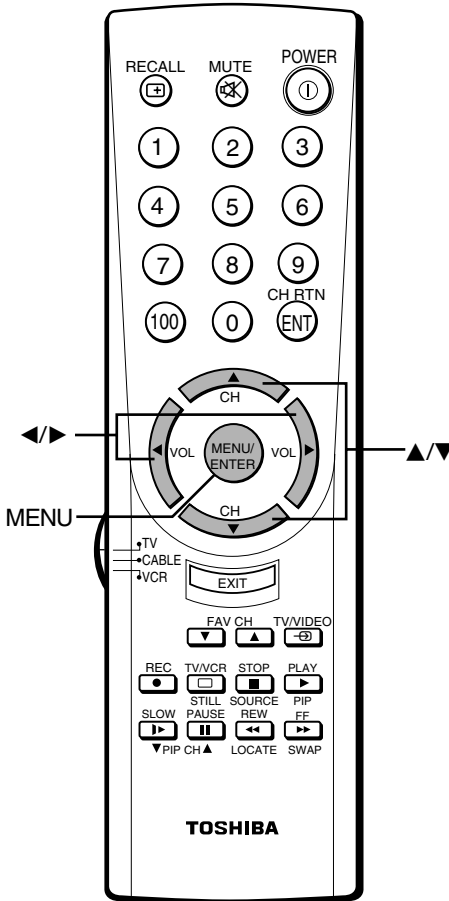
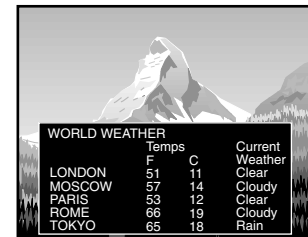

To turn off the closed-captioned feature:

Select OFF in step 4 above.

Note:

- A closed-captioned signal may not be decoded in the following situations:
 - When a videotape has been dubbed.
 - When the signal reception is weak.
 - When the signal reception is non-standard.
- If you select one of the Closed Caption Text modes and text is not available, a black rectangle may appear on your screen. If this happens, set the Closed Caption feature to OFF.

Using the V-CHIP control feature

Some TV programs and movies include signals that classify the content of the program (violence, sex, dialog, language). The V-CHIP (parental) control feature detects the signals and blocks the programs according to your selections.

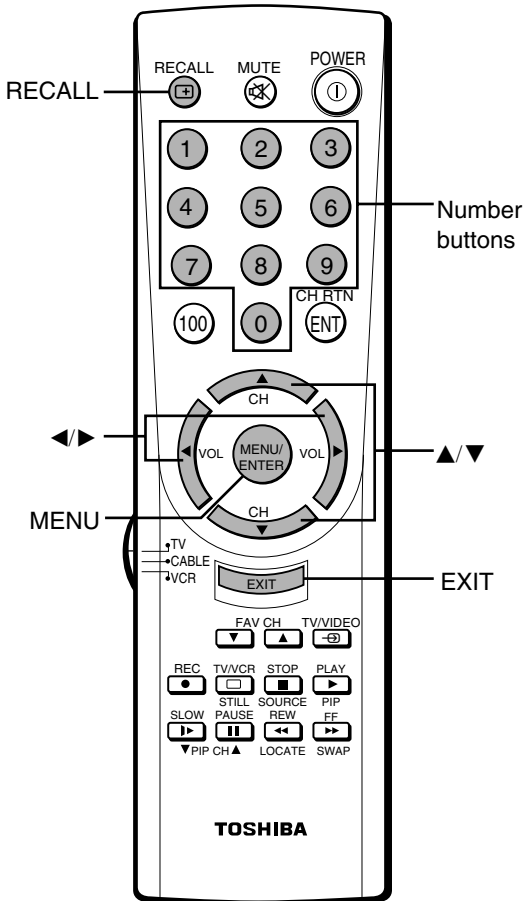

Opening the V-CHIP CONTROL menu

- 1 Press **MENU** until the Setup menu is displayed.
- 2 Press **▲** or **▼** until V-CHIP CONTROL is displayed in purple.
- 3 Press **◀** or **▶** to display the PIN code entering mode.
 - **Factory reset status:**
Press the **Number buttons** (0–9) to set a new 4-digit PIN code.
 - **When the PIN code is already stored:**
Press the **Number buttons** (0–9) to enter your 4-digit PIN code.
Also see “New PIN Code” on page 30.

```
TIMER:          0 MIN
TV/CABLE:      [TV]CABLE
CH PROGRAM
ADD/ERASE:    [ADD]ERASE
V-CHIP CONTROL
FAVORITE CH

MOVE[▼▲] START[◀▶]
```

```
BLOCKING IS RESET
PLEASE ENTER NEW PIN CODE

1110

SELECT[0-9] END[EXIT]
```

```
BLOCKING IS ACTIVE
PLEASE ENTER PIN CODE

1234

SELECT[0-9] END[EXIT]
```

```
INCORRECT PIN CODE
PLEASE ENTER PIN CODE

1235

SELECT[0-9] END[EXIT]
```

If the wrong PIN code is entered, the message “Incorrect PIN Code” appears. Enter the code again.

If you cannot remember the PIN code you stored, while in the PIN code entering mode, press **RECALL** four times within 5 seconds. The PIN code you stored will be returned to factory reset status.

- 4 When the correct PIN code is entered, after about 1 second the V-CHIP Control menu will display (as shown at right).

```
ENABLE BLOCKING : Y[N]
SET RATING
SET BLOCKING OPTIONS
NEW PIN CODE
BLOCK CHANNEL

MOVE[▼▲] SELECT[◀▶]
```

To return to normal viewing:
Press **EXIT**.

Continue to set each item following the steps on the next page.

V-CHIP CONTROL menu

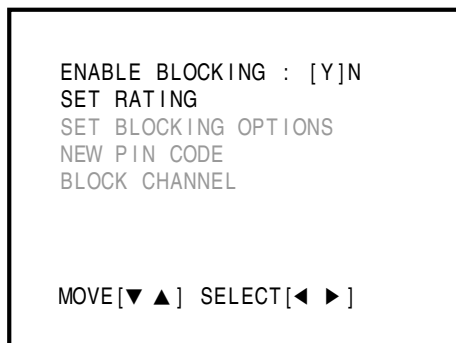

To select each item:
Press ▼ or ▲.

Adjusting the V-CHIP CONTROL menu

ENABLE BLOCKING

Press ◀ or ▶ to select “Y” (to activate blocking) or “N” (to deactivate blocking).

Note: The *BLOCK CHANNEL* function (page 31) is not affected by this selection.

SET RATING (Setting the movie or TV ratings to be blocked):

- 1 Press ◀ or ▶ to display the SET RATING menu.
- 2 Press ▼ (or ▲) to select the item.
- 3 Press ▶ to block (displays “X”) Press ◀ to unblock (displays “✓”).
- 4 Repeat steps 2 and 3 to set the next item.

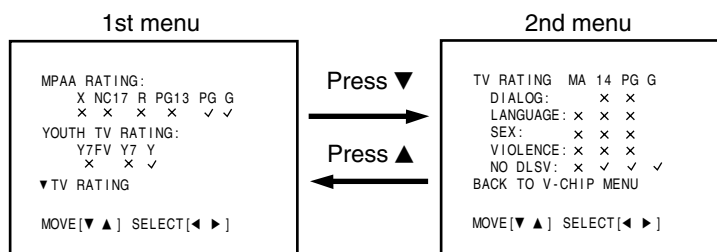

About Ratings

MPAA RATINGS: Independent rating system for movies

G: General Audience (Appropriate for all ages)

PG: Parental Guidance Suggested (Some material may not be suitable for children)

PG13: Parents Strongly Cautioned (Some material may not be appropriate for children under 13)

R: Restricted (Under 17 requires accompanying parent or adult guardian.)

NC17: Not intended for anyone 17 and under

X: X-rated (For adults only)

TV RATINGS: Independent rating system for Broadcasters

Y: All Children (This program is designed to be appropriate for all children)

Y7, Y7FV: Directed to Older Children (This program is designed for children age 7 and above. Note: Programs in which fantasy violence may be intense or more combative than other programs in this category are designated Y7-FV.)

G: General Audience (Most parents would find this program suitable for all ages.)

PG: Parental Guidance Suggested (This program contains material that parents may find unsuitable for younger children.)

D) Some suggestive dialog **L)** Infrequent coarse language

S) Some sexual situations **V)** Moderate violence

14: Parents Strongly Cautioned (This program contains some material that many parents would find unsuitable for children under 14 years.)

D) Intensely suggestive dialog **L)** Strong coarse language

S) Intense sexual situations **V)** Intense violence

MA: Mature Audience Only (This program is specifically designed to be viewed by adults and therefore may be unsuitable for children under 17.)

L) Crude or indecent language **S)** Explicit sexual activity

V) Graphic violence

The rating of the TV programs you are currently watching can be confirmed by pressing **RECALL**.

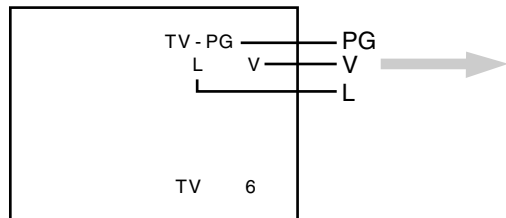

Using the V-CHIP control feature (continued)

V-CHIP CONTROL menu

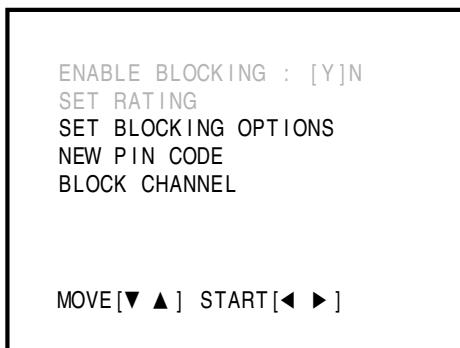

To select each item

Press ▼ or ▲.

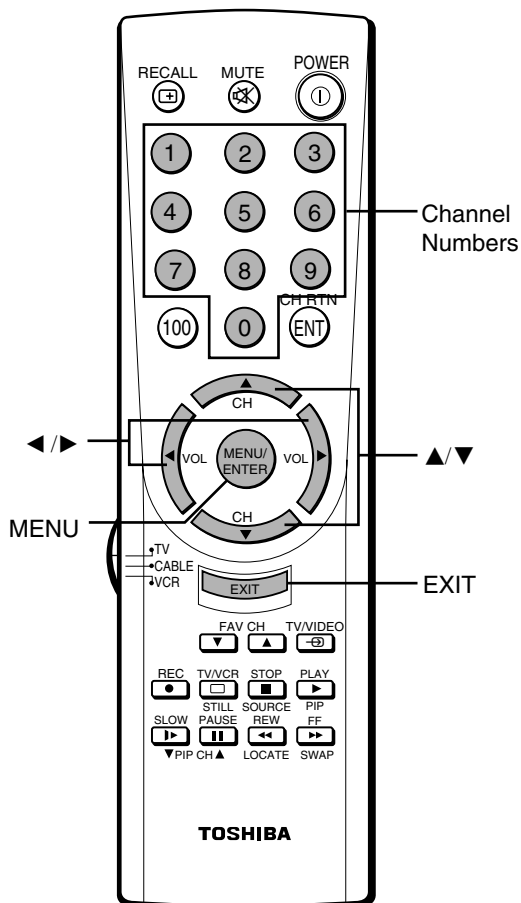

Adjusting the V-CHIP CONTROL menu (continued)

SET BLOCKING OPTIONS

Press ◀ or ▶ to display the SET BLOCKING OPTIONS menu, and then press ▼ or ▲ to select the item.

BLOCK MPAA UNRATED

Press ◀ or ▶ to select “Y”(block) or “N”(unblock) for unrated programs in the MPAA rating system.

BLOCK TV NONE RATING

Press ◀ or ▶ to select “Y”(block) or “N”(unblock) for programs rated NONE in the TV PARENTAL GUIDELINES.

If you select “Y,” the NOTICE shown below right will be displayed since the emergency information may also be blocked.

SET BLOCKING OPTION menu

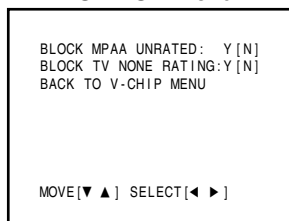

If you select “Y” in BLOCK TV NON RATING:

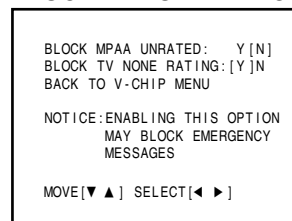

BACK TO V-CHIP MENU

Press ◀ or ▶ to return to the V-CHIP CONTROL menu.

NEW PIN CODE (Changing the PIN Code)

- 1 While in the V-CHIP Control menu, press ▼ or ▲ to select NEW PIN CODE, and then press ◀ or ▶ to display the menu.

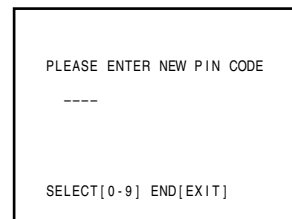

- 2 Press the **Channel Number** buttons (0–9) to enter a new 4-digit PIN code. The numbers you enter will replace the dashes in the display.

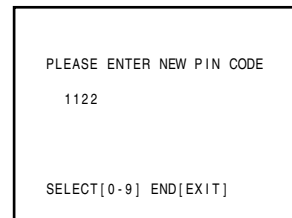

- 3 After about 1 second, the display will return to the V-CHIP CONTROL menu.

Unblocking programs temporarily

- 1 If you try to watch a TV program that exceeds the rating limits you set, the TV will enter into the program block mode.

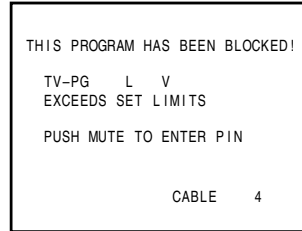

- 2 If you want to watch the blocked program temporarily, press **MUTE**.

Press the **Channel Number** buttons (0–9) to enter your 4-digit PIN code. If the number is correct, the block mode will be released. After 1 second, the normal picture will appear.

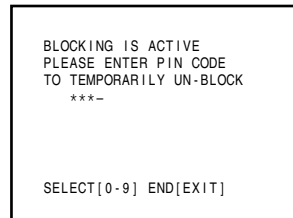

All blocking is disabled until the TV is turned off, and will be enabled when the TV is turned on again.

If a wrong PIN code is entered, the message, “Incorrect PIN Code” appears. Enter the code again. See page 28 for details on entering the PIN code.

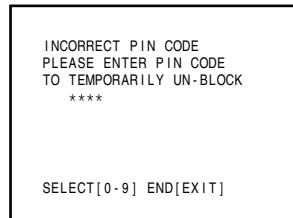

BLOCK CHANNEL function

You can use the BLOCK CHANNEL function to block specific channels. You will not be able to tune blocked channels unless you clear the setting.

You can block a maximum of 4 TV channels and 4 CABLE channels.

To block channels:

- 1 Select the channel you want to block.

- 2 While in the V-CHIP CONTROL menu, press **▼** or **▲** to select **BLOCK CHANNEL**.

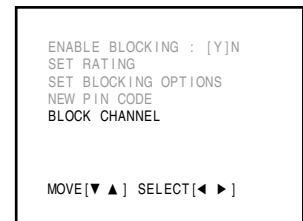

- 3 Press **◀** or **▶** to display the **BLOCK CHANNEL** menu.

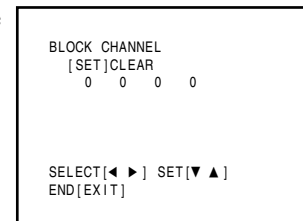

- 4 Press **◀** or **▶** to select **SET**, and then press **▼** or **▲** until the channel number to be blocked (“2” in this example) replaces “0” in the menu.

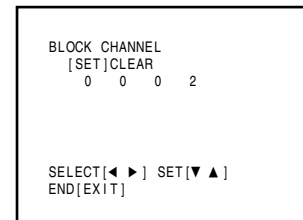

- 5 Repeat steps 1–4 for other channels.

- 6 Tune the TV to another channel before turning off the TV or the TV will be on a blocked channel the next time you turn it on.

To unblock channels:

- 1 Repeat steps 2–4 above, selecting **CLEAR** in step 4 (instead of SET).

- 2 Press **▼** or **▲** until “0” replaces the channel numbers (this unblocks all blocked channels; you cannot unblock individual channels).

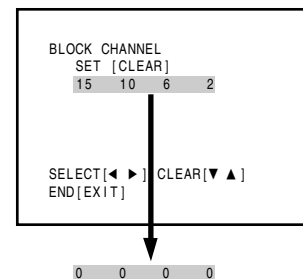

- 3 Press **EXIT** to clear the on-screen display.

Specifications

Television system	NTSC standard
Channel coverage	VHF: 2 through 13 UHF: 14 through 69 Cable TV: mid band (A-8 through A-1, A through I) super band (J through W) hyper band (AA through ZZ, AAA, BBB) ultra band (65 through 94, 100 through 125)
Power source	120V AC, 60Hz
Power consumption	32A41: 96W (average) 36A41: 92W (average)
Audio power	5W + 5W
Speaker type	2-3/8 x 4-3/4 inches (60 x 120 mm)
Audio/Video terminals	S-VIDEO INPUT Y-INPUT: 1V (p-p), 75 ohm, negative sync. C-INPUT: 0.286V (p-p) (burst signal), 75 ohm AUDIO/VIDEO INPUT VIDEO: 1V(p-p), 75 ohm, negative sync. AUDIO: 150mV(rms) (30% modulation equivalent, 47k ohm) ColorStream™ (component video) INPUT Y: 1V (p-p), 75 ohm C _R (P _R): 0.7 V (p-p), 75 ohm C _B (P _B): 0.7 V (p-p), 75 ohm AUDIO/VIDEO OUTPUT VIDEO: 1V(p-p), 75 ohm, negative sync. AUDIO: 150mV(rms) (30% modulation equivalent, 4.7k ohm)
Dimensions	32A41: Width 30-5/8 inches (778mm) Height 27-5/16 inches (693mm) Depth 22-11/16 inches (575mm) 36A41: Width 38-3/16 inches (970mm) Height 30-1/16 inches (764mm) Depth 25-1/4 inches (641mm)
Mass	32A41: 74.5 lbs (33.8kg) 36A41: 154 lbs (69.9kg)
Supplied accessories	Remote Control with 2 size “AA” batteries
Optional TV stand	32A41: ST3240 36A41: ST3641

Design and specifications are subject to change without notice.

Troubleshooting

Before calling service personnel, please check the following chart for a possible cause of the problem you are experiencing. A minor adjustment on your part may eliminate the problem and restore your TV reception.

Problem	Checks and Adjustments	Page
TV will not turn on	• Make sure the power cord is plugged in, and then press POWER .	15
	• The remote control batteries may be dead. Replace the batteries.	8
No picture, no sound	• Check the antenna/cable connections.	5
No sound, picture OK	• The sound may be muted. Press VOLUME ► .	15
	• The station may have broadcast difficulties. Try another channel.	18
	• Make sure the MTS feature is set correctly.	24–25
Poor sound, picture OK	• The station may have broadcast difficulties. Try another channel.	18
	• An appliance near the TV may be causing interference. Move or turn off the appliance.	
Poor picture, sound OK	• Check the antenna/cable connections.	5
	• The station may have broadcast difficulties. Try another channel.	18
	• An appliance near the TV may be causing interference. Move or turn off the appliance.	
	• Adjust the Picture menu.	20
Poor reception of broadcast channels	• The station may have broadcast difficulties. Try another channel.	18
	• Check the antenna connections.	5
	• If using a VCR, make sure the TV/VCR button is set correctly.	10
No UHF, VHF OK	• Make sure the TV/CABLE function is set to the mode that corresponds to the signal source type (cable company or outside antenna).	16
Black box appears on the screen	• The Closed Caption Text feature (T1, T2, T3, or T4) may be on. Set the Closed Caption feature to OFF.	27
Cannot select a certain channel	• The channel may be locked out by the BLOCK CHANNEL function. Unblock the channel.	31
	• The channel may have been erased from the channel memory by the ADD/ERASE function. Reprogram the channel into channel memory.	16–17
Multiple images (ghosts)	• The station may have broadcast difficulties. Try another channel. • Antenna reception may be poor. Use a highly directional outdoor antenna.	
Poor color or no color	• The station may have broadcast difficulties. Try another channel.	18
	• An appliance near the TV may be causing interference. Move or turn off the appliance.	
	• Adjust the TINT and/or COLOR in the Picture menu.	20
	• If you change the direction of the TV while the TV is on, the picture may suffer from color shading. Turn off the TV and allow it to cool for about 30 minutes; then turn it on again.	
No stereo or SAP sound from an MTS broadcast	• Make sure the MTS feature is set correctly.	24–25
The remote control does not operate	• Make sure the TV/CABLE/VCR switch is set correctly.	10
	• There may be an obstruction between the remote control and the TV. Remove the obstruction and retry the remote control.	
	• The remote control batteries may be dead. Replace the batteries.	8

Limited United States warranty

Toshiba America Consumer Products, Inc. ("TACP") and Toshiba Hawaii Inc. ("THI") make the following limited warranties. These limited warranties extend to the original consumer purchaser or any person receiving this set as a gift from the original consumer purchaser and to no other purchaser or transferee.

Limited One (1) Year Warranty

TACP and THI warrant this product and its parts against defects in materials or workmanship for a period of one (1) year after the date of original retail purchase. During this period, TACP and THI will repair or replace a defective part, at their option, with a new or refurbished part, without charge to you. TACP/THI Authorized Service Center personnel will come to your home when warranty service is required. Depending on the type of repair required, either the service will be performed in your home or the set will be taken to the TACP/THI authorized service center for repair and returned to your home at no cost to you.

Limited Two (2) Year Warranty of Picture Tube

TACP and THI further warrant the picture tube in this product against defects in materials or workmanship for a period of two (2) years after the date of original retail purchase. During this period, TACP and THI will repair or replace a defective picture tube at their option, with a new or refurbished picture tube, without charge to you, except that, if a defective picture tube is replaced after one (1) year from the date of the original retail purchase, you pay labor charges involved in the replacement.

Rental Units

The warranty for rental units begins with the first rental or thirty (30) days from the date of shipment to the rental firm, whichever comes first.

Commercial Units

Products sold and used for commercial use have a limited ninety (90) day warranty for all parts, labor and picture tube.

Owner's Manual and Demographic Card

You should read this owner's manual thoroughly before operating this product. You should complete and mail the enclosed Demographic card within ten days after you, or the person who has given you this product as a gift, purchased this product. This is one way to enable TACP/THI to provide you with better customer service and improved products. Failure to return the Demographic card will not affect your rights under this warranty.

Your Responsibility

The above warranties are subject to the following conditions;

- (1) You must retain your bill of sale or provide other proof of purchase.
- (2) All warranty servicing of this product must be made by an Authorized TACP/THI Service Center .
- (3) These warranties are effective only if the product is purchased and operated in the U.S.A. or Puerto Rico.
- (4) Labor service charges for set installation, setup, adjustment of customer controls, and installation or repair of antenna systems are not covered by this warranty. Reception problems caused by inadequate antenna systems are your responsibility.
- (5) Warranties extend only to defects in materials or workmanship as limited above, and do not extend to any product or parts that have been lost or discarded by you, or to damage to products or parts caused by misuse or accident, damage caused by Acts of God such as lightning or fluctuations in electric power, improper installation, improper maintenance, or use in violation of instructions furnished by us, or to units which have been modified or had the serial number removed, altered, defaced, or rendered illegible.

How to Obtain Warranty Service

If after following all of the operating instructions in this manual and checking the section "Troubleshooting," you find that service is needed:

- (1) To find the nearest Toshiba Authorized Service Center, visit our web site at www.toshiba.com/tacp and click "Customer Solutions," or call us toll-free at 1-800-631-3811.
In Hawaii, contact Toshiba Hawaii, Inc., Service, 327 Kamakee Street, Honolulu, HI 96814, (808) 591-9281.
- (2) Present your bill of sale or other proof of purchase to the Authorized Service Center. "Authorized TACP/THI service center personnel will come to your home when warranty service is required. Depending on the type of repair required, either the service will be performed in your home or the TV set will be taken to the TACP/THI authorized service center for repair and returned to your home at no cost to you."

**For additional information, visit our web site:
www.toshiba.com/tacp**

All warranties implied by state law, including the implied warranties of merchantability and fitness for a particular purpose, are expressly limited to the duration of the limited warranties set forth above. With the exception of any warranties implied by state law as hereby limited, the foregoing warranty is exclusive and in lieu of all other warranties, guarantees, agreements and similar obligations of manufacturer or seller with respect to the repair or replacement of any parts. In no event shall TACP or THI be liable for consequential or incidental damages.

No person, agent, distributor, dealer or company is authorized to change, modify or extend the terms of these warranties in any manner whatsoever. The time within which action must be commenced to enforce any obligation of TACP or THI arising under this warranty or under any state or law of the United States or any state thereof, is hereby limited to 90 days from the date you discover, or should have discovered, the defect. This limitation does not apply to implied warranties arising under state law.

This warranty gives you specific legal rights and you may also have other rights which may vary from state to state. Some states do not allow limitation on how long an implied warranty lasts, when an action may be brought, or the exclusion or limitation of incidental or consequential damages; therefore, the above provisions may not apply to you.



ATTENTION CANADIAN CONSUMERS:

Canadian consumers are requested to complete the special Canadian "Warranty Registration Form" enclosed, and forward this completed form with a copy of the bill of sale to TOSHIBA OF CANADA to "Register and Validate" their warranty.

Products purchased in the U.S.A. and used in Canada are not covered by these warranties.

Products purchased in Canada and used in the U.S.A. are not covered by these warranties.

REV. 09-01

TOSHIBA AMERICA CONSUMER PRODUCTS, INC.

HEAD OFFICE/82 TOTOWA ROAD, WAYNE, NEW JERSEY 07470
NATIONAL SERVICE DIVISION/1420B TOSHIBA DRIVE, LEBANON, TENNESSEE 37087

TOSHIBA HAWAII, INC.

HEAD OFFICE/327 KAMAKEE STREET, HONOLULU, HAWAII 96814, U.S.A.

TOSHIBA OF CANADA LTD.

HEAD OFFICE/191 McNABB STREET, MARKHAM, ONTARIO, L3R 8H2, CANADA TEL: (905) 470-5400
SERVICE CENTERS/TORONTO: 191 McNABB STREET, MARKHAM, ONTARIO, L3R 8H2, CANADA TEL: (905) 470-5400
MONTREAL: 1643, NORTH SERVICE RD., TRANS-CANADA HIGHWAY, DORVAL QUEBEC, H9P 1J1, CANADA
TEL: (514) 856-4100
VANCOUVER: 22171 FRASER WOOD WAY, RICHMOND, B.C., V6W 1J5 TEL: (604) 303-2500

MANUFACTURED BY

TOSHIBA AMERICA CONSUMER PRODUCTS, INC.

ColorStream is a registered trademark of Toshiba America Consumer Products, Inc.

PRINTED IN USA
(01-03)

TOSHIBA

23565217